



ATEX 2014/34/EU GUIDELINES

**GUIDE TO APPLICATION OF THE DIRECTIVE 2014/34/EU OF
THE EUROPEAN PARLIAMENT AND OF THE COUNCIL OF 26
FEBRUARY 2014 ON THE HARMONISATION OF THE LAW OF
THE MEMBER STATES RELATING TO EQUIPMENT AND
PROTECTIVE SYSTEMS INTENDED FOR USE IN POTENTIALLY
EXPLOSIVE ATMOSPHERES**

4th EDITION – November 2022

This ATEX 2014/34/EU Guidelines have been drafted by:

the European Commission services: Mario Gabrielli Cossellu and Jan Mayerhöfer (general editor)

with the participation and support of the members of the ATEX 2014/34/EU Working Group.

The fourth edition was issued in November 2022 to include the agreements reached at the ATEX Expert Group meeting held on 20 May 2021: see the "Minutes of the ATEX Expert Group meeting" on the Commission's Expert Group webpage related to the ATEX sector.

Brussels, 2022

PRELIMINARY NOTES

1. *These **ATEX Guidelines** are intended to be a manual for all parties directly or indirectly affected by **Directive 2014/34/EU**¹, commonly referred to as the ATEX ("Atmosphères explosibles") "product" directive, applicable from **20 April 2016**, replacing the previous Directive 94/9/EC applicable from 1 July 2003 until 19 April 2016.*
2. *Readers' attention is drawn to the fact that these Guidelines are intended only to facilitate the application of Directive 2014/34/EU, and it is the relevant national transposition of the text of the Directive which is legally binding. However, this document does represent a reference for ensuring consistent application of the Directive by all interested parties and stakeholders. The ATEX Guidelines are intended to help ensure the free movement of products within the scope of the ATEX Directive in the European Union² by consensus amongst Member States' government experts and other parties concerned.*
3. *These Guidelines have been prepared by the competent services of the Directorate-General for Internal Market, Industry, Entrepreneurship and SMEs (DG Growth)³, in co-operation with representatives and experts from EU Member States, European standardisation, notified bodies, industry and other relevant sectoral stakeholders, with the specific contribution of the "New ATEX Guidelines Editorial Group (NAGEG)". They are based on the last issue (4th Edition - September 2012 - Revision December 2013) of the Guidelines on the application of Directive 94/9/EC, applicable until 19 April 2016, as well as on other horizontal and vertical guidance documents.*
4. *The European Commission services will undertake to maintain these Guidelines. It is our goal to ensure that the information provided is both timely and accurate. If errors are brought to our attention, we will try to correct them as soon as possible. However, the Commission accepts no responsibility or liability whatsoever with regard to the information in this document.
This information is:*
 - *of a general nature only and is not intended to address the specific circumstances of any particular individual or entity;*
 - *not necessarily comprehensive, complete, accurate or up-to-date;*
 - *sometimes refers to external information over which the Commission services have no control and for which the Commission assumes no responsibility;*
 - *not professional or legal advice.*

¹ Directive 2014/34/EU of the European Parliament and of the Council of 26 February 2014 on the harmonisation of the laws of the Member States relating to equipment and protective systems intended for use in potentially explosive atmospheres (recast) (OJEU L 96, 29.3.2014, p. 309).

² According to the agreement related to the European Economic Area (EEA) (Decision of the Council and the Commission 94/1/EC of 13 December 1993, OJ L1, 3.1.1994, p.1), the territories of Iceland, Liechtenstein and Norway have to be considered, for the implementation of Directive 2014/34/EU, in the same right as of the EU territory. When this term, EU territory, is used in this Guide, the same applies to the EEA territory.

³ The former Directorate-General for Enterprise and Industry, until 31 October 2014.

5. *All references to the CE marking and the EU declaration of conformity in these ATEX Guidelines relate only to the Directive 2014/34/EU. To place products falling under Directive 2014/34/EU in the European Union territory, all other relevant legislation must be applied.
For wider information on the whole system, see the latest version of "The 'Blue Guide' on the implementation of EU product rules", available in all the EU official languages on <http://ec.europa.eu/DocsRoom/documents/18027>.*
6. *Further guidance, especially concerning specific types of products, can be found on the European Commission's website on EUROPA regarding ATEX: <http://ec.europa.eu/growth/sectors/mechanical-engineering/atex/>.
Any query can be addressed to the GROW ATEX functional mailbox: GROW-DIR-ATEX@ec.europa.eu.*

INTRODUCTION

The objective of these ATEX Guidelines is to clarify certain matters and procedures referred to in Directive 2014/34/EU¹ concerning equipment and protective systems intended for use in potentially explosive atmospheres. The Guidelines should be used in conjunction with the Directive itself and with the European Commission's document "*The 'Blue Guide' on the implementation of EU product rules*"⁴.

These Guidelines are not only for the use of Member States' competent authorities, but also by the main economic operators concerned, such as manufacturers, their trade associations, bodies in charge of the preparation of standards as well as those entrusted with the conformity assessment procedures.

First and foremost, this document must ensure that, when correctly applied, the Directive leads to the removal of obstacles and difficulties related to the free circulation (free movement) of goods within the European Union (EU) and the European Economic Area (EEA). It should be noted that the statements in these Guidelines refer only to the application of Directive 2014/34/EU unless otherwise indicated. All parties concerned should be aware of other requirements, which may also apply.

Directive 2014/34/EU is a total harmonisation directive and a "New Approach"⁵ directive aligned to the [New Legislative Framework](#). It lays down essential health and safety requirements and leaves it to standards, primarily European harmonised standards, to give technical expression of the relevant requirements contained in the Directive.

The ATEX Directive 2014/34/EU replaced the previous ATEX Directive 94/9/EC which was applicable between 1 July 2013 and 19 April 2016. As of 20 April 2016, Directive 2014/34/EU, as transposed into the national legislation of the EU Member States, is the sole legal instrument applicable.

The reader will want to be aware that where ATEX products are intended for use in a place of work, national and EU legislation, intended to ensure the safety of employees, will usually apply. In this respect different legislation applies to land based industries, the underground extraction of coal and other minerals, and offshore oil production⁶.

⁴ <http://ec.europa.eu/DocsRoom/documents/18027>.

⁵ Council Resolution of 7 May 1985 on a new approach to technical harmonization and standards (OJ C 136, 4.6.1985, p. 1).

⁶ Among others, the ATEX "workplace" Directive 1999/92/EC of the European Parliament and of the Council of 16 December 1999 on minimum requirements for improving the safety and health protection of workers potentially at risk from explosive atmospheres (OJ L 23, 28.1.2000, p. 57).

TABLE OF CONTENTS

Preamble to the ATEX Directive - The Citations and the Recitals

	<u>§ 1</u>	<u>The citations</u>
	<u>§ 2</u>	<u>The legal basis of the ATEX Directive</u>
	<u>§ 3</u>	<u>The recitals</u>
Recital 1	<u>§ 4</u>	<u>The previous ATEX Directive</u>
Recitals 2, 3	<u>§ 5</u>	<u>The New Legislative Framework</u>
Recitals 4, 5	<u>§ 6</u>	<u>The scope of the ATEX Directive</u>
Recital 6	<u>§ 7</u>	<u>Health and safety</u>
Recital 7	<u>§ 8</u>	<u>Protection against explosion hazards</u>
Recitals 8, 9	<u>§ 9</u>	<u>Safety of ATEX equipment and protective systems: essential health and safety requirements</u>
Recitals 10, 11, 12	<u>§ 10</u>	<u>Responsibilities of economic operators</u>
Recital 13	<u>§ 11</u>	<u>Responsibilities of manufacturers: conformity assessment</u>
Recitals 14, 15	<u>§ 12</u>	<u>Responsibilities of importers</u>
Recital 16	<u>§ 13</u>	<u>Responsibilities of distributors</u>
Recital 17	<u>§ 14</u>	<u>Obligations of the manufacturer for economic operators</u>
Recitals 18, 19	<u>§ 15</u>	<u>Information and traceability of products for market surveillance</u>
Recital 20	<u>§ 16</u>	<u>Essential health and safety requirements: presumption of conformity from harmonised standards</u>
Recital 21	<u>§ 17</u>	<u>Formal objections to harmonised standards</u>
Recital 22	<u>§ 18</u>	<u>Conformity assessment procedures</u>
Recitals 23, 24	<u>§ 19</u>	<u>EU declaration of conformity</u>
Recital 25	<u>§ 20</u>	<u>The CE marking</u>
Recitals 26, 27, 28, 29, 30, 31, 32, 33, 34, 35	<u>§ 21</u>	<u>Conformity assessment bodies: notified bodies</u>
Recitals 36, 37	<u>§ 22</u>	<u>Compliance of products placed on the market and market surveillance</u>
Recitals 38, 39, 40	<u>§ 23</u>	<u>The safeguard clause procedure</u>
Recitals 41, 42, 43, 44	<u>§ 24</u>	<u>Implementing powers and procedures</u>
Recitals 45, 46	<u>§ 25</u>	<u>The ATEX Committee</u>
Recital 47	<u>§ 26</u>	<u>Implementing acts concerning measures on non-compliant products</u>
Recital 48	<u>§ 27</u>	<u>Enforcement: penalties</u>
Recital 49	<u>§ 28</u>	<u>Transitional arrangements</u>
Recital 50	<u>§ 29</u>	<u>Subsidiarity and proportionality</u>
Recitals 51, 52	<u>§ 30</u>	<u>Transposition</u>

The Articles of the ATEX Directive

	<u>§ 31</u>	<u>General provisions</u>
Article 1	<u>§ 32</u>	<u>Products covered by the ATEX Directive</u>
	<u>§ 33</u>	<u>Used, repaired or modified products and spare parts</u>

	<u>§ 34 Place of intended use</u>
	<u>§ 35 Interface to different potentially explosive atmospheres</u>
	<u>§ 36 Safety devices, controlling devices and regulating devices as defined in Article 1(b)</u>
	<u>§ 37 Products excluded from the scope of the ATEX Directive</u>
	<u>§ 38 Examples of equipment not covered by Directive 2014/34/EU</u>
Article 2	<u>§ 39 Definitions</u>
	<u>§ 40 Equipment</u>
	<u>§ 41 "Own" ignition source</u>
	<u>§ 42 Non-electrical equipment</u>
	<u>§ 43 Electrical equipment</u>
	<u>§ 44 Combined equipment (assemblies)</u>
	<u>§ 45 Protective systems</u>
	<u>§ 46 Components</u>
	<u>§ 47 Difference between equipment and components. Specific requirements given in the manual of products</u>
	<u>§ 48 Examples and problems on equipment and components</u>
	<u>§ 49 Explosive atmosphere and potentially explosive atmosphere</u>
	<u>§ 50 Potentially explosive atmosphere in the sense of Directive 2014/34/EU</u>
	<u>§ 51 Equipment group and category</u>
	<u>§ 52 Intended use</u>
	<u>§ 53 Making available on the market</u>
	<u>§ 54 Placing on the market</u>
	<u>§ 55 Manufacturer</u>
	<u>§ 56 Authorised representative</u>
	<u>§ 57 Importer</u>
	<u>§ 58 Distributor</u>
	<u>§ 59 Economic operators</u>
	<u>§ 60 Technical specification</u>
	<u>§ 61 Harmonised standard</u>
	<u>§ 62 Accreditation and national accreditation body</u>
	<u>§ 63 Conformity assessment</u>
	<u>§ 64 Recall and withdrawal</u>
	<u>§ 65 Union harmonisation legislation</u>
	<u>§ 66 CE marking</u>
Article 3	<u>§ 67 Making available on the market and putting into service</u>
	<u>§ 68 Making available ATEX products on the market</u>
	<u>§ 69 Placing ATEX products on the market</u>
	<u>§ 70 Putting ATEX products into service</u>
Article 4	<u>§ 71 Essential health and safety requirements</u>
Article 5	<u>§ 72 Free movement</u>
	<u>§ 73 Obligations of economic operators</u>

Article 6	<u>§ 74 Obligations of manufacturers</u>
	<u>§ 75 Use of subcontractor services by a manufacturer</u>
	<u>§ 76 Manufacturers and conformity assessment based on quality assurance (Annex IV, Annex VII)</u>
	<u>§ 77 Certificates and CE marking without the name of the original manufacturer</u>
	<u>§ 78 Manufacturing of ATEX products for own use</u>
	<u>§ 79 The official languages of the European Union</u>
Article 7	<u>§ 80 Authorised representatives</u>
Article 8	<u>§ 81 Obligations of importers</u>
Article 9	<u>§ 82 Obligations of distributors</u>
Article 10	<u>§ 83 Obligations of manufacturers for importers and distributors</u>
Article 11	<u>§ 84 Identification of economic operators</u>
	<u>§ 85 Conformity of the product</u>
Article 12	<u>§ 86 Presumption of conformity of products</u>
	<u>§ 87 European harmonised standards in the Official Journal</u>
	<u>§ 88 Standardisation programme</u>
Article 13	<u>§ 89 Conformity assessment procedures</u>
	<u>§ 90 Conformity assessment procedures in the case of different categories within one product</u>
	<u>§ 91 Clarification for equipment with categories 2 or 3</u>
	<u>§ 92 Exceptional derogations of the conformity assessment procedures</u>
Article 14	<u>§ 93 EU declaration of conformity</u>
	<u>§ 94 Written attestation of conformity for components</u>
Articles 15, 16	<u>§ 95 The CE marking. Rules and conditions for affixing the CE marking and other markings</u>
	<u>§ 96 Notification of conformity assessment bodies: notified bodies</u>
Article 17	<u>§ 97 Notification</u>
Article 18	<u>§ 98 Notifying authorities</u>
Article 19	<u>§ 99 Requirements relating to notifying authorities</u>
Article 20	<u>§ 100 Information obligation on notifying authorities</u>
Article 21	<u>§ 101 Requirements relating to notified bodies</u>
Article 22	<u>§ 102 Presumption of conformity of notified bodies</u>
Article 23	<u>§ 103 Subsidiaries of and subcontracting by notified bodies</u>
Articles 24, 25	<u>§ 104 Application for notification and notification procedure</u>
Article 26	<u>§ 105 Identification numbers and lists of notified bodies. The NANDO database</u>
Article 27	<u>§ 106 Changes to notification</u>
Article 28	<u>§ 107 Challenge of the competence of notified bodies</u>
Article 29	<u>§ 108 Operational obligations of notified bodies</u>
	<u>§ 109 Documents issued by the notified body</u>
	<u>§ 110 Provision of evaluation and test results with EU-type examination certificates</u>

	<u>§ 111 Acceptance of test results of manufacturers by a notified body</u>
	<u>§ 112 Minimum content of a European standardised ATEX test and assessment report</u>
	<u>§ 113 Retention of technical documentation</u>
Article 30	<u>§ 114 Appeal against decisions of notified bodies</u>
Article 31	<u>§ 115 Information obligation on notified bodies</u>
Article 32	<u>§ 116 Exchange of experience</u>
Article 33	<u>§ 117 Coordination of notified bodies. The European ATEX Notified Bodies Group (ExNBG)</u>
	<u>§ 118 Status and use of ExNBG Clarification Sheets issued by the European ATEX Notified Bodies Group</u>
	<u>§ 119 EU market surveillance, control of products entering the EU market and EU safeguard procedure</u>
Article 34	<u>§ 120 EU market surveillance and control of products entering the EU market</u>
Article 35	<u>§ 121 Procedure for dealing with products presenting a risk at national level</u>
Article 36	<u>§ 122 EU safeguard procedure</u>
Article 37	<u>§ 123 Compliant products which present a risk</u>
Article 38	<u>§ 124 Formal non-compliance</u>
	<u>§ 125 Committee, transitional and final provisions</u>
Article 39	<u>§ 126 The ATEX Committee</u>
Article 40	<u>§ 127 Enforcement: penalties</u>
Article 41	<u>§ 128 Transitional provisions</u>
Article 42	<u>§ 129 Transposition</u>
Article 43	<u>§ 130 Repeal</u>
Article 44	<u>§ 131 Entry into force and application</u>
Article 45	<u>§ 132 Addresses</u>

The Annexes to the ATEX Directive

Annex I - Criteria determining the classification of equipment-groups into categories

	<u>§ 133 Classification of equipment-groups into categories</u>
1. Equipment-group I	<u>§ 134 Equipment-group I, category M1</u>
	<u>§ 135 Equipment-group I, category M2</u>
2. Equipment-group II	<u>§ 136 Equipment-group II, category 1</u>
	<u>§ 137 Equipment-group II, category 2</u>
	<u>§ 138 Equipment-group II, category 3</u>

Annex II - Essential health and safety requirements relating to the design and construction of equipment and protective systems intended for use in potentially explosive atmospheres

	<u>§ 139 Essential health and safety requirements</u>
	<u>§ 140 Preliminary observations</u>

1. Common requirements for Equipment and protective systems

1.0.	<u>§ 141 General requirements</u>
1.0.1., 1.0.2.	<u>§ 142 Principles of integrated explosion safety. Risk assessment for ATEX products</u>
1.0.3., 1.0.4.	<u>§ 143 Special conditions: checking, maintenance, surrounding area</u>
1.0.5.	<u>§ 144 Marking</u> <u>§ 145 CE marking</u> <u>§ 146 Supplementary/specific marking</u> <u>§ 147 Additional marking for standards</u> <u>§ 148 Marking of small products</u> <u>§ 149 Marking of components</u> <u>§ 150 Marking of assemblies</u>
1.0.6.	<u>§ 151 Instructions</u>
1.1., 1.1.1., 1.1.2., 1.1.3	<u>§ 152 Selection of materials</u>
1.2., 1.2.1., 1.2.2.	<u>§ 153 Design and construction</u>
1.2.3.	<u>§ 154 Enclosed structures and prevention of leaks</u>
1.2.4	<u>§ 155 Dust deposits</u>
1.2.5	<u>§ 156 Additional means of protection</u>
1.2.6	<u>§ 157 Safe opening</u>
1.2.7	<u>§ 158 Protection against other hazards</u>
1.2.8	<u>§ 159 Overloading of equipment</u>
1.2.9	<u>§ 160 Flameproof enclosure systems</u>
1.3.	<u>§ 161 Potential ignition sources</u>
1.3.1.	<u>§ 162 Hazards arising from different ignition sources</u>
1.3.2.	<u>§ 163 Hazards arising from static electricity</u>
1.3.3.	<u>§ 164 Hazards arising from stray electric and leakage currents</u>
1.3.4.	<u>§ 165 Hazards arising from overheating</u>
1.3.5.	<u>§ 166 Hazards arising from pressure compensation operations</u>
1.4., 1.4.1., 1.4.2.	<u>§ 167 Hazards arising from external effects</u>
1.5., 1.5.1., 1.5.2., 1.5.3.	<u>§ 168 Requirements in respect of safety-related devices</u>
1.5.4.	<u>§ 169 Control and display units</u>
1.5.5., 1.5.6, 1.5.7.	<u>§ 170 Requirements in respect of devices with a measuring function for explosion protection</u>
1.5.8.	<u>§ 171 Risks arising from software</u>
1.6., 1.6.1., 1.6.2.	<u>§ 172 Integration of safety requirements relating to the system</u>
1.6.3.	<u>§ 173 Hazards arising from power failure</u>
1.6.4.	<u>§ 174 Hazards arising from connections</u>
1.6.5.	<u>§ 175 Placing of warning devices as part of equipment</u>

2. Supplementary requirements in respect of equipment

<u>§ 176 Supplementary requirements in respect of equipment</u>

3. Supplementary requirements in respect of protective systems

§ 177 Supplementary requirements in respect of protective systems

Annex III - Module B: EU-type examination

- 1., 2. § 178 EU-type examination
3. § 179 The application for EU-type examination
4. § 180 Tasks to be performed by the notified body
5. § 181 The evaluation report
6. § 182 The EU-type examination certificate
§ 183 The EU-type examination certificate and the responsibilities of stakeholders
7. § 184 Changes and modifications
8. § 185 Obligations for the notified body
§ 186 Validity of EU-type examination certificates
9. § 187 Obligations for the manufacturer
10. § 188 Authorised representative

Annex IV - Module D: Conformity to type based on quality assurance of the production process

1. § 189 Conformity to type based on quality assurance of the production process
2. § 190 Manufacturing
3. § 191 Quality system
4. § 192 Surveillance under the responsibility of the notified body
5. § 193 CE-marking, EU declaration of conformity and attestation of conformity
6. § 194 Obligations for the manufacturer: retention of documentation - quality assurance
7. § 195 Obligations for the notified body
8. § 196 Authorised representative

Annex V - Module F: Conformity to type based on product verification

1. § 197 Conformity to type based on product verification
2. § 198 Manufacturing
- 3., 4. § 199 Verification
5. § 200 CE-marking, EU declaration of conformity and attestation of conformity
6. § 201 The notified body's identification number
7. § 202 Authorised representative

Annex VI - Module C1: Conformity to type based on internal production control plus supervised product testing

1. § 203 Conformity to type based on internal production control plus supervised product testing
2. § 204 Manufacturing
3. § 205 Product checks

4. [§ 206 CE-marking, EU declaration of conformity and attestation of conformity](#)
5. [§ 207 Authorised representative](#)

Annex VII - Module E: Conformity to type based on product quality assurance

1. [§ 208 Conformity to type based on product quality assurance](#)
2. [§ 209 Manufacturing](#)
3. [§ 210 Quality system](#)
4. [§ 211 Surveillance under the responsibility of the notified body](#)
5. [§ 212 CE-marking, EU declaration of conformity and attestation of conformity](#)
6. [§ 213 Obligations for the manufacturer](#)
7. [§ 214 Obligations for the notified body](#)
8. [§ 215 Authorised representative](#)

Annex VIII - Module A: Internal product control

1. [§ 216 Internal product control](#)
2. [§ 217 Technical documentation](#)
3. [§ 218 Manufacturing](#)
4. [§ 219 CE-marking, EU declaration of conformity and attestation of conformity](#)
5. [§ 220 Authorised representative](#)

Annex IX - Module G: Conformity based on unit verification

1. [§ 221 Conformity based on unit verification](#)
2. [§ 222 Technical documentation](#)
3. [§ 223 Manufacturing](#)
4. [§ 224 Verification](#)
5. [§ 225 CE-marking, EU declaration of conformity and attestation of conformity](#)
6. [§ 226 Authorised representative](#)

Annex X - EU declaration of conformity

- [§ 227 The EU declaration of conformity](#)

Annex XI

- [§ 228 References of the repealed Directive](#)

Annex XII - Correlation table

- [§ 229 Correlation table](#)

Statement of the European Parliament

- [§ 230 Statement of the European Parliament](#)

Application of Directive 2014/34/EU alongside others that may apply

- § 231 Electromagnetic Compatibility Directive 2014/30/EU (EMC)
- § 232 Low Voltage Directive 2014/35/EU (LVD)
- § 233 Machinery Directive 2006/42/EC
- § 234 Transport of Dangerous Goods Directives 2008/68/EC and 98/91/EC (ADR)
- § 235 Personal Protective Equipment Directive 89/686/EEC (PPE)
- § 236 Pressure Equipment Directive 2014/68/EU (PED) and Simple Pressure Vessels Directive 2014/29/EU (SPVD)
- § 237 Radio Equipment Directive 2014/53/EU (RED)
- § 238 Gas Appliances Directive 2009/142/EC (GAD)
- § 239 Construction Products Regulation (EU) No 305/2011 (CPR)
- § 240 Marine Equipment Directive 2014/90/EU (MED)

Application of Directive 2014/34/EU to specific equipment

- § 241 Inerting systems
- § 242 Paint spray booths
- § 243 Filter units and vented silo bins
- § 244 Gas turbines
- § 245 Steam turbines
- § 246 Petrol pumps
- § 247 Cables
- § 248 Rotating mechanical seals
- § 249 Bucket elevators
- § 250 Fork lift trucks
- § 251 Transportable, pressurised cabins ("modules")
- § 252 Automatically lubricating systems
- § 253 Electrical trace heating systems
- § 254 Motor protection for category 3 motors
- § 255 Wi-Fi access points
- § 256 Refrigerators and storage cabinets for volatile substances

Borderline list – ATEX products

Specific marking of explosion protection (&x) drawn from Directive 84/47/EEC

Useful ATEX websites

DIRECTIVE 2014/34/EU OF THE EUROPEAN PARLIAMENT AND OF THE COUNCIL

of 26 February 2014

on the harmonisation of the laws of the Member States relating to equipment and protective systems intended for use in potentially explosive atmospheres (recast)

(Text with EEA relevance)

PREAMBLE TO THE ATEX DIRECTIVE - THE CITATIONS AND THE RECITALS

§ 1 The citations

The citations included in the preamble to the ATEX Directive 2014/34/EU indicate the legal basis of the Directive, the opinions expressed by the relevant consultative Committee and the procedure according to which the Directive was adopted.

THE EUROPEAN PARLIAMENT AND THE COUNCIL OF THE EUROPEAN UNION,

Having regard to the Treaty on the Functioning of the European Union, and in particular Article 114 thereof,

Having regard to the proposal from the European Commission,

After transmission of the draft legislative act to the national parliaments,

Having regard to the opinion of the European Economic and Social Committee ⁽¹⁾,

Acting in accordance with the ordinary legislative procedure ⁽²⁾,

⁽¹⁾ OJ C 181, 21.6.2012, p. 105.

⁽²⁾ Position of the European Parliament of 5 February 2014.

§ 2 The legal basis of the ATEX Directive

The legal basis of the ATEX Directive 2014/34/EU is provided by Article 114 of the [Treaty on the Functioning of the European Union \(TFEU\)](#)⁷ (ex-Article 95 of the EC Treaty)⁸ that enables the European Union to adopt measures to harmonise the legislation of the Member States in order to ensure the establishment and functioning

⁷ OJ C 326, 26.10.2012, p. 47.

⁸ Sometimes the ATEX "product" Directive (94/9/EC until 19 April 2016; 2014/34/EU as by 20 April 2016) is still referred to as "the ATEX 95 Directive", when the ATEX "workplace" Directive 1999/92/EC is mentioned as "the ATEX 137 Directive", being based on the Article 153 of the TFEU (ex-Article 137 of the EC Treaty).

of the single internal market. Such measures must take as a basis the highest possible level of protection of the health and safety of people and of the environment. The Directive thus has a dual objective: to permit the free movement of products with the internal market whilst ensuring a high level of protection of health and safety.

Following the proposal by the European Commission, the Directive was adopted by the European Parliament and the Council of the European Union after consulting the European Economic and Social Committee, according to the ordinary legislative procedure (formerly known as "co-decision") set out in Article 294 of the TFEU.

The footnotes to the citation give the references and dates of the successive steps of the procedure. The text of the ATEX Directive 2014/34/EU was published on the Official Journal of the European Union (OJEU) L 96, 29.3.2014, p. 309.

§ 3 *The recitals*

The recitals, also known as *consideranda*, introduce the main provisions of the Directive and present the reasons for their adoption. Some of the recitals explain the changes that have been made in the new ATEX Directive 2014/34/EU compared with the previous Directive 94/9/EC (basically, the alignment to the [New Legislative Framework](#) through the provisions of [Decision No 768/2008/EC](#): see [section § 5](#)).

The recitals do not have legal force as such and do not usually figure in the national legislation transposing and implementing the Directive. However, they help to understand the Directive, in particular, by clarifying the meaning of certain provisions. When interpreting the text of the Directive, the Courts may take the recitals into consideration in order to ascertain the intention of the legislators.

In the following comments, reference is made to the Articles and Annexes of the Directive introduced by each of the recitals. For further explanations, please refer to the comments on the Articles and Annexes concerned.

(1) Directive 94/9/EC of the European Parliament and of the Council of 23 March 1994 on the approximation of the laws of the Member States concerning equipment and protective systems intended for use in potentially explosive atmospheres ⁽³⁾ has been substantially amended ⁽⁴⁾. Since further amendments are to be made, that Directive should be recast in the interests of clarity.

⁽³⁾ OJ L 100, 19.4.1994, p. 1.

⁽⁴⁾ See Annex XI, Part A.

§ 4 *The previous ATEX Directive*

The first recital recalls that the new ATEX Directive 2014/34/EU is based on the previous Directive 94/9/EC. This Directive was a total harmonisation directive, i.e. its provisions replaced existing divergent national and European legislation which covered the same subjects. In particular, the previous ATEX Directive replaced and repealed, as from 1 July 2003, a framework Directive on electrical equipment for use

in potentially explosive atmospheres (76/117/EEC)⁹ as amended by Directive 79/196/EEC, and a Directive concerning electrical equipment for use in potentially explosive atmospheres in mines susceptible to fire damp (82/130/EEC)¹⁰.

Directive 94/9/EC was subject to two corrigenda¹¹ and two amendments¹². It was applicable from 1 July 2003 and remained in force until 19 April 2016.

Directive 2014/34/EU is termed as a recast of the ATEX Directive since the modifications are presented in the form of a new Directive.

- (2) Regulation (EC) No 765/2008 of the European Parliament and of the Council of 9 July 2008 setting out the requirements for accreditation and market surveillance relating to the marketing of products ⁽⁵⁾ lays down rules on the accreditation of conformity assessment bodies, provides a framework for the market surveillance of products and for controls on products from third countries, and lays down the general principles of the CE marking.
- (3) Decision No 768/2008/EC of the European Parliament and of the Council of 9 July 2008 on a common framework for the marketing of products ⁽⁶⁾ lays down common principles and reference provisions intended to apply across sectoral legislation in order to provide a coherent basis for revision or recasts of that legislation. Directive 94/9/EC should be adapted to that Decision.

⁽⁵⁾ OJ L 218, 13.8.2008, p. 30.

⁽⁶⁾ OJ L 218, 13.8.2008, p. 82.

§ 5 The New Legislative Framework

The ATEX Directive 2014/34/EU is the result of the alignment of the previous Directive 94/9/EC to the [New Legislative Framework](#) (NLF), configured as the improvement and update of the regulatory method known as the "New Approach to technical harmonisation and standards". The set of legislative acts of the NLF includes the [Regulation \(EC\) No 765/2008](#) and the [Decision No 768/2008/EC](#).

See also § 1.2. "The 'New Legislative Framework'" in "[The 'Blue Guide' on the implementation of EU product rules](#)".

In particular, the contents of Directive 2014/34/EU related – among others – to definitions and obligations of economic operators, to notified bodies, to conformity assessment procedures and declaration of conformity, come directly from the NLF Decision, as additions and/or terminology adaptation.

⁹ OJ L 24, 31.1.1976, p. 45; as last amended by Directive 90/487/EEC (OJ L 270, 2.10.1990, p. 23).

¹⁰ OJ L 59, 2.3.1982, p. 10.

¹¹ Corrigendum OJ L 21, 26.1.2000, p. 42, and Corrigendum OJ L 304, 5.12.2000, p. 19.

¹² Regulation (EC) No 1882/2003 of the European Parliament and of the Council of 29 September 2003, OJ L 284, 31.10.2003, p. 1, and Regulation (EU) No 1025/2012 of the European Parliament and of the Council of 25 October 2012, OJ L 316, 14.11.2012, p. 12.

- (4) This Directive covers products which are new to the Union market when they are placed on the market; that is to say they are either new products made by a manufacturer established in the Union or products, whether new or second-hand, imported from a third country.
- (5) This Directive should apply to all forms of supply, including distance selling.

§ 6 *The scope and the objective of the ATEX Directive*

The scope and the objective of the ATEX Directive remain unchanged from the previous Directive 94/9/EC to the new Directive 2014/34/EU, to ensure free movement for the products to which it applies in the EU territory. Therefore, the ATEX Directive provides for harmonised requirements and procedures to establish compliance for products placed on the EU market for the first time.

The ATEX Directive carries specific obligations for the person (natural or legal) who makes products available on the market and/or puts products into service, be it the manufacturer, its authorised representative, the importer or the distributor. The Directive does not regulate the use of equipment in a potentially explosive atmosphere which is covered by different EU or national legislation: for instance, the ATEX "workplace" [Directive 1999/92/EC](#) (see footnote 7 in the "Introduction").

The Directive is applicable to all forms of making products available on the EU market, regardless of the selling technique. Therefore, it includes distance selling and selling through electronic means (Internet, e-commerce...), as the whole Union harmonisation legislation on products. This is particularly related to the contents of Article 3 on "Making available on the market and putting into service (see sections [§§ 67-70](#)).

- (6) It is the duty of Member States to protect, on their territory, the health and safety of persons, especially workers, and, where appropriate, domestic animals and property, especially against the hazards resulting from the use of equipment and systems providing protection against potentially explosive atmospheres.

§ 7 *Health and safety*

The obligations for Member States related to health and safety are based on the provisions of the [Treaty on the Functioning of the European Union \(TFEU\)](#), in particular Articles 4, 36, 114, 153 and 169.

The protection of health and safety is both a fundamental duty and a prerogative of the Member States. Since the ATEX Directive 2014/34/EU harmonises the health and safety requirements for the design and construction of equipment and protective systems for use in potentially explosive atmospheres at EU level, the responsibility of Member States to protect health and safety of persons etc. with regards to the associated risks implies that the requirements of the ATEX Directive are correctly applied.

It should be recalled that the use of equipment in a potentially explosive atmosphere is covered by the ATEX "workplace" [Directive 1999/92/EC](#) (see footnote 7 in the "Introduction"). This Directive specifies minimum requirements and can be added to by national requirements of the Member States.

- (7) Directive 94/9/EC has made positive steps towards effective protection against explosion hazards for both mining and surface equipment. Those two groups of equipment are used in a large number of commercial and industrial sectors and possess considerable economic significance.

§ 8 Protection against explosion hazards

The new ATEX Directive 2014/34/EU ensures continuity with the substantial provisions of the previous Directive 94/9/EC, recognising its positive contribution to health and safety by providing for protection against explosion hazards for both mining and surface equipment during almost 13 years of operation in the European Union and the EEA countries.

- (8) Compliance with the health and safety requirements is essential in order to ensure the safety of equipment and protective systems. Those requirements should be subdivided into general and additional requirements which need to be met by equipment and protective systems. In particular, the additional requirements should take account of existing or potential hazards. Equipment and protective systems should, therefore, meet at least one of those requirements where this is necessary for their proper functioning or is to apply to their intended use. The notion of intended use is of prime importance for the explosion-proofing of equipment and protective systems. It is essential that manufacturers supply full information. Specific, clear marking of equipment and protective systems, stating their use in a potentially explosive atmosphere, should also be necessary.
- (9) Compliance with the essential health and safety requirements laid down in this Directive should be imperative in order to ensure the safety of equipment and protective systems. For the implementation of those requirements, both the technology obtained at the time of manufacture and overriding technical and economic requirements should be taken into account.

§ 9 Safety of ATEX equipment and protective systems: essential health and safety requirements

According to the principles and objectives of the New Approach and the [New Legislative Framework](#), essential requirements regarding health and safety need to be defined through which a high level of protection will be ensured. These essential health and safety requirements (EHSRs) are listed in Annex II to the ATEX Directive 2014/34/EU and are specific with respect to:

- potential ignition sources of equipment intended for use in potentially explosive atmospheres;

- autonomous protective systems intended to come into operation following an explosion with the prime objective to halt the explosion immediately and/or limit the effects of explosion flames and pressures;
- safety devices intended to contribute to the safe functioning of such equipment with respect to ignition source and to the safe functioning of autonomous protective systems;
- components with no autonomous function essential to the safe functioning of such equipment or autonomous protective system(s).

Since 1 July 2003 relevant products could only be placed on the market in the EU territory¹³, freely moved and operated as designed and intended in the expected environment if they comply with the ATEX Directive (and other relevant legislation), that is to say, Directive 94/9/EC – until 19 April 2016 – or Directive 2014/34/EU – from 20 April 2016.

Directive 2014/34/EU provides for harmonised requirements for electrical and non-electrical equipment, intended for use in environments which are potentially explosive due to dust or gas hazards, and protective systems. Safety devices intended for use outside explosive atmospheres which are required for or contribute to the safe functioning of equipment or protective systems with respect to risks of explosion are also included.

- (10) Economic operators should be responsible for the compliance of products with this Directive, in relation to their respective roles in the supply chain, so as to ensure a high level of protection of health and safety of persons, especially workers, and, where appropriate, protection of domestic animals and property, and to guarantee fair competition on the Union market.
- (11) All economic operators intervening in the supply and distribution chain should take appropriate measures to ensure that they only make available on the market products which are in conformity with this Directive. It is necessary to provide for a clear and proportionate distribution of obligations which correspond to the role of each economic operator in the supply and distribution chain.
- (12) In order to facilitate communication between economic operators, market surveillance authorities and consumers, Member States should encourage economic operators to include a website address in addition to the postal address.

§ 10 Responsibilities of economic operators

Union harmonisation legislation defines the manufacturer, the authorised representative, the importer and the distributor as "economic operators". Within the [New Legislative Framework](#), the responsibilities and obligations of the economic operators are defined more in detail: all of them have to play key roles in the supply

¹³ Directive 2014/34/EU is also applicable in the EEA territories (see footnote 2 in the "Preliminary notes") as well in other territories where a suitable international agreement is in operation, as for example Switzerland under a "Mutual Recognition Agreement" (MRA) or Turkey under a "Custom Union Agreement". See the DG Growth website for more details:
<http://ec.europa.eu/growth/industry/international-aspects/>.

chain, in particular in terms of compliance of products, appropriate measures, communication and co-operation.

The inclusion of a website address in addition to the postal address is related to the requirements for manufacturers in Article 6(7) and for importers in Article 8(3).

See also § 3. "The actors in the product supply chain and their obligations" in "[The 'Blue Guide' on the implementation of EU product rules](#)".

- (13) The manufacturer, having detailed knowledge of the design and production process, is best placed to carry out the conformity assessment procedure. Conformity assessment should therefore remain solely the obligation of the manufacturer.

§ 11 Responsibilities of manufacturers: conformity assessment

Conformity assessment according to the conformity assessment procedures applicable to the product, is the responsibility of the manufacturer only, whether the Directive provides for the involvement of a notified conformity assessment body, or not.

- (14) It is necessary to ensure that products from third countries entering the Union market comply with this Directive, and in particular that appropriate conformity assessment procedures have been carried out by manufacturers with regard to those products. Provision should therefore be made for importers to make sure that the products they place on the market comply with the requirements of this Directive and that they do not place on the market products which do not comply with such requirements or present a risk. Provision should also be made for importers to make sure that conformity assessment procedures have been carried out and that product marking and documentation drawn up by manufacturers are available for inspection by the competent national authorities.

- (15) When placing a product on the market, every importer should indicate on the product his name, registered trade name or registered trade mark and the postal address at which he can be contacted. Exceptions should be provided for in cases where the size or nature of the product does not allow it. This includes cases where the importer would have to open the packaging to put his name and address on the product.

§ 12 Responsibilities of importers

The importer is the economic operator established in the Union who places a product from a third country on the Union market for the first time. He has important and clearly defined responsibilities under the Directive. To a large extent they build on the type of responsibilities which a manufacturer based in the EU is subjected to.

The importer must ensure that the manufacturer has correctly fulfilled his obligations. The importer is not a simple re-seller of products, but has a key role to play in guaranteeing the compliance of imported products.

- (16) The distributor makes a product available on the market after it has been placed on the market by the manufacturer or the importer and should act with due care to ensure that its handling of the product does not adversely affect the compliance of the product.

§ 13 Responsibilities of distributors

Along with manufacturers and importers, distributors are the third category of economic operators who are subject to specific obligations. The distributor is a natural or a legal person in the supply chain, other than the manufacturer or the importer, who makes a product available on the market.

Retailers, wholesalers and other distributors in the supply chain are not required to have a preferential relationship with the manufacturer like the authorised representative. A distributor acquires products for further distribution either from a manufacturer, from an importer, or from another distributor.

Distributors must act with due care in relation to the applicable requirements of the Directive. Due care refers to the effort made by an ordinarily prudent or reasonable party to avoid harm to another, taking the circumstances into account. It refers to the level of judgment, precaution, prudence, determination and activity that a person would reasonably be expected to do under particular circumstances.

They have to know, for instance, which products must bear the CE marking, what information is to accompany the product (for example the EU declaration of conformity), what are the language requirements for labelling, user instructions or other accompanying documents, and what is a clear indication of the product being non-compliant. Distributors have an obligation to demonstrate to the national market surveillance authority that they have acted with due care and ensure that the manufacturer, or his authorised representative, or the person who provided him with the product has taken the measures required by the Directive as listed in the responsibilities and obligations for distributors, as far as can be reasonably expected.

- (17) Any economic operator that either places a product on the market under his own name or trade mark or modifies a product in such a way that compliance with this Directive may be affected should be considered to be the manufacturer and should assume the obligations of the manufacturer.

§ 14 Obligations of the manufacturer for economic operators

If the product is marketed under another person's name or trademark, this person will be considered as the manufacturer.

The responsibilities of the manufacturer apply also to any natural or legal person who assembles, packs, processes or labels ready-made products and places them on the market under his own name or trademark. Further, the responsibility of the manufacturer is placed on any person who changes the intended use of a product in such a way that different essential or other legal requirements will become

applicable, or substantially modifies or re-builds a product (thus creating a new product), with a view to placing it on the market.

- (18) Distributors and importers, being close to the market place, should be involved in market surveillance tasks carried out by the competent national authorities, and should be prepared to participate actively, providing those authorities with all necessary information relating to the product concerned.
- (19) Ensuring traceability of a product throughout the whole supply chain helps to make market surveillance simpler and more efficient. An efficient traceability system facilitates the market surveillance authorities' task of tracing economic operators who made non-compliant products available on the market. When keeping the information required under this Directive for the identification of other economic operators, economic operators should not be required to update such information in respect of other economic operators who have either supplied them with a product or to whom they have supplied a product.

§ 15 Information and traceability of products for market surveillance

Economic operators (manufacturers, distributors and importers) must co-operate with national authorities to carry out effective market surveillance activities, including provision of information and ensuring the traceability of products throughout the whole supply chain.

Article 11 of the Directive deals with "Identification of economic operators" (see [section § 84](#)).

- (20) This Directive should be limited to the expression of the essential health and safety requirements. In order to facilitate conformity assessment with those requirements it is necessary to provide for a presumption of conformity for products which are in conformity with harmonised standards that are adopted in accordance with Regulation (EU) No 1025/2012 of the European Parliament and of the Council of 25 October 2012 on European Standardisation ⁽¹⁾ for the purpose of expressing detailed technical specifications of those requirements.

⁽¹⁾ OJ L 316, 14.11.2012, p. 12.

§ 16 Essential health and safety requirements: presumption of conformity from harmonised standards

The ATEX Directive 2014/34/EU relies on the regulatory method known as the "New Approach to technical harmonisation and standards", as aligned to the [New Legislative Framework](#). The legislation itself sets out the mandatory essential health and safety requirements (EHSRs) that products placed on the EU market must fulfil, and the procedures for assessing their conformity.

Detailed technical solutions for complying with these EHSRs are given in European harmonised standards, defined and adopted according to the [Regulation \(EU\) No 1025/2012](#) (the "Standardisation Regulation"), in particular Articles 2 and 10. Application of harmonised standards remains voluntary, but confers a presumption of conformity with the EHSRs they cover.

- (21) Regulation (EU) No 1025/2012 provides for a procedure for objections to harmonised standards where those standards do not entirely satisfy the requirements of this Directive.

§ 17 Formal objections to harmonised standards

Article 11 of the Standardisation [Regulation \(EU\) No 1025/2012](#) sets out the procedure for disputing a harmonised standard – the "formal objection" procedure – where the standard is considered by a Member State or by the European Parliament to not entirely satisfy the requirements which it aims to cover and which are set out in the relevant EU product legislation.

- (22) In order to enable economic operators to demonstrate and the competent authorities to ensure that products made available on the market conform to the essential health and safety requirements it is necessary to provide for conformity assessment procedures. Decision No 768/2008/EC establishes modules for conformity assessment procedures, which include procedures from the least to the most stringent, in proportion to the level of risk involved and the level of safety required. In order to ensure inter-sectoral coherence and to avoid ad-hoc variants, conformity assessment procedures should be chosen from among those modules.

§ 18 Conformity assessment procedures

Among the modules established by the [Decision No 768/2008/EC](#) within the [New Legislative Framework](#), the ATEX Directive 2014/34/EU includes seven modules for conformity assessment procedures (Annexes III to IX) for assessing the conformity of equipment and protective systems intended for use in potentially explosive atmospheres with the applicable essential health and safety requirements.

See also § 5.1. "Modules for conformity assessment" in "[The 'Blue Guide' on the implementation of EU product rules](#)".

- (23) Manufacturers should draw up an EU declaration of conformity to provide information required under this Directive on the conformity of a product with the requirements of this Directive and of other relevant Union harmonisation legislation.
- (24) To ensure effective access to information for market surveillance purposes, the information required to identify all applicable Union acts should be available in a single EU declaration of conformity. In order to reduce the administrative burden on

economic operators, that single EU declaration of conformity may be a dossier made up of relevant individual declarations of conformity.

§ 19 EU declaration of conformity

Recitals 23 and 24 introduce the provisions related to the EU declaration of conformity, to be drafted up by the manufacturer for products to be placed on the EU market. The ATEX Directive 2014/34/EU includes such provisions in Article 14 (in particular, paragraph 3 on the single EU declaration of conformity) and in Annex X setting out the model structure.

See also § 4.4 "EU Declaration of conformity" in "[The 'Blue Guide' on the implementation of EU product rules](#)".

(25) The CE marking, indicating the conformity of a product, is the visible consequence of a whole process comprising conformity assessment in a broad sense. General principles governing the CE marking are set out in Regulation (EC) No 765/2008. Rules governing the affixing of the CE marking should be laid down in this Directive.

§ 20 The CE marking

Recital 25 introduces the provisions related to the CE marking, making reference to the general principles set out in Article 30 of the [New Legislative Framework Regulation \(EC\) No 765/2008](#). The ATEX Directive 2014/34/EU includes the reference to those provisions as well as the rules and conditions for affixing the CE marking, and other markings, in Articles 15 and 16.

See also § 4.5.1. "CE marking" in "[The 'Blue Guide' on the implementation of EU product rules](#)".

(26) Certain conformity assessment procedures set out in this Directive require the intervention of conformity assessment bodies, which are notified by the Member States to the Commission.

(27) Experience has shown that the criteria set out in Directive 94/9/EC that conformity assessment bodies have to fulfil to be notified to the Commission are not sufficient to ensure a uniformly high level of performance of notified bodies throughout the Union. It is, however, essential that all notified bodies perform their functions to the same level and under conditions of fair competition. That requires the setting of obligatory requirements for conformity assessment bodies wishing to be notified in order to provide conformity assessment services.

(28) If a conformity assessment body demonstrates conformity with the criteria laid down in harmonised standards, it should be presumed to comply with the corresponding requirements set out in this Directive.

- (29) In order to ensure a consistent level of quality in the performance of conformity assessment, it is also necessary to set requirements for notifying authorities and other bodies involved in the assessment, notification and monitoring of notified bodies.
- (30) The system set out in this Directive should be complemented by the accreditation system provided for in Regulation (EC) No 765/2008. Since accreditation is an essential means of verifying the competence of conformity assessment bodies, it should also be used for the purposes of notification.
- (31) Transparent accreditation as provided for in Regulation (EC) No 765/2008, ensuring the necessary level of confidence in certificates of conformity, should be considered by the national public authorities throughout the Union as the preferred means of demonstrating the technical competence of conformity assessment bodies. However, national authorities may consider that they possess the appropriate means of carrying out that evaluation themselves. In such cases, in order to ensure the appropriate level of credibility of evaluations carried out by other national authorities, they should provide the Commission and the other Member States with the necessary documentary evidence demonstrating the compliance of the conformity assessment bodies evaluated with the relevant regulatory requirements.
- (32) Conformity assessment bodies frequently subcontract parts of their activities linked to the assessment of conformity or have recourse to a subsidiary. In order to safeguard the level of protection required for the products to be placed on the Union market, it is essential that conformity assessment subcontractors and subsidiaries fulfil the same requirements as notified bodies in relation to the performance of conformity assessment tasks. Therefore, it is important that the assessment of the competence and the performance of bodies to be notified and the monitoring of bodies already notified cover also activities carried out by subcontractors and subsidiaries.
- (33) It is necessary to increase the efficiency and transparency of the notification procedure and, in particular, to adapt it to new technologies so as to enable online notification.
- (34) Since notified bodies may offer their services throughout the Union, it is appropriate to give the other Member States and the Commission the opportunity to raise objections concerning a notified body. It is therefore important to provide for a period during which any doubts or concerns as to the competence of conformity assessment bodies can be clarified before they start operating as notified bodies.
- (35) In the interests of competitiveness, it is crucial that notified bodies apply the conformity assessment procedures without creating unnecessary burdens for economic operators. For the same reason, and to ensure equal treatment of economic operators, consistency in the technical application of the conformity assessment procedures needs to be ensured. That can best be achieved through appropriate coordination and cooperation between notified bodies.

§ 21 Conformity assessment bodies: notified bodies

Conformity assessment bodies, known as notified bodies for being notified by the competent national authorities of the EU Member States to the Commission and to the other Member States, are required to intervene in a number of conformity assessment procedures of Directive 2014/34/EU, as indicated in:

- Annex III: EU-type examination
- Annex IV: Quality assurance of the production process
- Annex V: Product verification
- Annex VI: Internal production control plus supervised product testing
- Annex VII: Product quality assurance
- Annex IX: Unit verification

The ATEX Directive devotes the whole Chapter 4 – Articles 17 to 33 – to notified bodies, basically reproducing the relevant contents of the [Decision No 768/2008/EC](#). Rules on accreditation for notified bodies are provided in the [Regulation \(EC\) No 765/2008](#).

See also §§ 5.2 "Conformity assessment bodies" and 5.3 "Notification", as well as § 6 "Accreditation", in "[The 'Blue Guide' on the implementation of EU product rules](#)".

- (36) Member States should take all appropriate measures to ensure that products covered by this Directive may be placed on the market only if, when properly stored and used for their intended purpose, or under conditions of use which can be reasonably foreseen, they do not endanger the health and safety of persons. Products covered by this Directive should be considered as non-compliant with the essential health and safety requirements laid down in this Directive only under conditions of use which can be reasonably foreseen, that is when such use could result from lawful and readily predictable human behaviour.
- (37) In order to ensure legal certainty, it is necessary to clarify that rules on Union market surveillance and control of products entering the Union market provided for in Regulation (EC) No 765/2008 apply to products covered by this Directive. This Directive should not prevent Member States from choosing the competent authorities to carry out those tasks.

§ 22 Compliance of products on the market and market surveillance

The term "market surveillance" designates the activity of the competent national authorities of the Member States, checking the conformity of products subject to the EU harmonisation legislation, after they have been placed on the market or put into service on the EU market, and taking the necessary action to deal with non-compliant products.

See also § 7 "Market surveillance" in "[The 'Blue Guide' on the implementation of EU product rules](#)".

- (38) Directive 94/9/EC already provides for a safeguard procedure which is necessary to allow the possibility for contesting the conformity of a product. In order to increase transparency and to reduce processing time, it is necessary to improve the existing

safeguard procedure, with a view to making it more efficient and drawing on the expertise available in Member States.

- (39) The existing system should be supplemented by a procedure under which interested parties are informed of measures intended to be taken with regard to products presenting a risk to the health or safety of persons, especially workers, or to domestic animals or property. It should also allow market surveillance authorities, in cooperation with the relevant economic operators, to act at an earlier stage in respect of such products.
- (40) Where the Member States and the Commission agree as to the justification of a measure taken by a Member State, no further involvement of the Commission should be required, except where non-compliance can be attributed to shortcomings of a harmonised standard.

§ 23 The safeguard clause procedure

The "safeguard clause procedure" for dealing with non-compliant and dangerous products under the ATEX Directive 2014/34/EU comes from the [Decision No 768/2008/EC](#), with the aim to make it more efficient and effective in terms of information, communication, resources and results.

See also § 7.5.1. "Safeguard mechanisms" in ["The 'Blue Guide' on the implementation of EU product rules"](#).

When non-compliance is related to shortcomings of a harmonised standard, the "formal objection" procedure applies (see section [§ 17](#)).

- (41) In order to ensure uniform conditions for the implementation of this Directive, implementing powers should be conferred on the Commission. Those powers should be exercised in accordance with Regulation (EU) No 182/2011 of the European Parliament and of the Council of 16 February 2011 laying down the rules and general principles concerning mechanisms for control by Member States of the Commission's exercise of implementing powers ⁽¹⁾.
- (42) The advisory procedure should be used for the adoption of implementing acts requesting the notifying Member State to take the necessary corrective measures in respect of notified bodies that do not meet or no longer meet the requirements for their notification.
- (43) The examination procedure should be used for the adoption of implementing acts with respect to compliant products which present a risk to the health or safety of persons or to other aspects of public interest protection.
- (44) The Commission should adopt immediately applicable implementing acts where, in duly justified cases relating to compliant products which present a risk to the health or safety of persons or to domestic animals or property, imperative grounds of urgency so require.

(¹) OJ L 55, 28.2.2011, p. 13.

§ 24 Implementing powers and procedures

Implementing powers are conferred and monitored by the EU legislators (European Parliament and the Council) to the European Commission to ensure that certain measures are uniformly implemented across the EU, in accordance with Article 291 of the [Treaty on the Functioning of the European Union \(TFEU\)](#). [Regulation \(EU\) No 182/2011](#) (the "Comitology Regulation") establishes the rules and general principles on the exercise of such implementing powers by the Commission.

Within the ATEX Directive 2014/34/EU, adoption of an implementing act is required in case of objections raised concerning a notified body (*see section § 107*), and in case of compliant products on the market presenting a risk. According to Article 2(2) and (3) of Regulation (EU) No 182/2011, the examination procedure applies for implementing acts with respect to products, being related to "protection of the health or safety of humans and animals" (b)(iii), when the advisory procedure applies for implementing acts on corrective measures in respect of notified bodies.

- (45) In line with established practice, the committee set up by this Directive can play a useful role in examining matters concerning the application of this Directive raised either by its chair or by a representative of a Member State in accordance with its rules of procedure.
- (46) When matters relating to this Directive, other than its implementation or infringements, are being examined, i.e. in a Commission expert group, the European Parliament should in line with existing practice receive full information and documentation and, where appropriate, an invitation to attend such meetings.

§ 25 The ATEX Committee

The ATEX Directive 2014/34/EU confirms the role of the ATEX Committee in examining different questions related to the implementation, application and management of the Directive. Specific provisions related to the committee procedure are set out in Article 39 of the Directive.

Under the [Regulation \(EU\) No 182/2011](#) (the "Comitology Regulation"), the ATEX Committee has an obligation of information and documentation to the European Parliament, about the issues under discussion, other than those specifically related to the implementation or infringements of the Directive.

- (47) The Commission should, by means of implementing acts and, given their special nature, acting without the application of Regulation (EU) No 182/2011, determine whether measures taken by Member States in respect of non-compliant products are justified or not.

§ 26 Implementing acts concerning measures on non-compliant products

Adoption of an implementing act by the Commission is required not only in cases related to notified bodies or to compliant products presenting a risk (see [section § 22](#)), but also when Member States take actions in respect of non-compliant products (the safeguard clause procedure – see [section § 23](#)).

(48) Member States should lay down rules on penalties applicable to infringements of the provisions of national law adopted pursuant to this Directive and ensure that those rules are enforced. The penalties provided for should be effective, proportionate and dissuasive.

§ 27 Enforcement: penalties

Recital (48) corresponds to Article 40 of the Directive.

(49) It is necessary to provide for reasonable transitional arrangements that allow the making available on the market and putting into service, without the need to comply with further product requirements, of products that have already been placed on the market in accordance with Directive 94/9/EC before the date for application of national measures transposing this Directive. Distributors should therefore be able to supply products that have been placed on the market, namely stock that is already in the distribution chain, before the date of application of national measures transposing this Directive.

§ 28 Transitional arrangements

Specific transitional provisions for products and certificates, from the previous Directive 94/9/EC to the new ATEX Directive 2014/34/EU, are provided for in Article 41. These are in line with the other EU harmonisation legislation aligned to the [New Legislative Framework](#).

(50) Since the objective of this Directive, namely to ensure that products on the market fulfil the requirements providing for a high level of protection of health and safety of persons, especially workers, and, where appropriate, protection of domestic animals and property, while guaranteeing the functioning of the internal market, cannot be sufficiently achieved by the Member States but can rather, by reason of its scale and effects, be better achieved at Union level, the Union may adopt measures, in accordance with the principle of subsidiarity as set out in Article 5 of the Treaty on European Union. In accordance with the principle of proportionality, as set out in that Article, this Directive does not go beyond what is necessary in order to achieve that objective.

§ 29 Subsidiarity and proportionality

Recital 50 is a justification of the ATEX Directive 2014/34/EU with respect to the principles of subsidiarity and proportionality set out in Article 5 of the [Treaty on European Union \(TEU\)](#). According to these principles, the European Union shall take

action only if the same objectives cannot be better achieved by the action of the Member States.

In fact, it is clear that without the Directive, manufacturers of equipment and equipment for potentially explosive atmospheres would have to apply different rules, requirements and procedures for safety of products in each EU Member State, which would both constitute a serious obstacle to the single internal market (free circulation of goods) and be a less effective means of ensuring and improving safety of ATEX products.

- (51) The obligation to transpose this Directive into national law should be confined to those provisions which represent a substantive amendment as compared to the earlier Directive. The obligation to transpose the provisions which are unchanged arises under the earlier Directive.
- (52) This Directive should be without prejudice to the obligations of the Member States relating to the time-limits for transposition into national law and the dates of application of the Directive set out in Annex XI, Part B,

§ 30 Transposition

Transposition provisions are provided for in Article 42 of the Directive.

A "Guidance document on the ATEX Directive transition from 94/9/EC to 2014/34/EU"¹⁴ is available on the Commission's ATEX website. It includes a list of "Frequently Asked Questions and Answers", covering both "horizontal" and "sectoral" questions, this is to say, those common to all the EU legislation aligned to the [New Legislative Framework](#) and those specifically related to Directive 2014/34/EU. Having been issued in October 2015, it reflects the result of discussions developed during the transition period, notably at the workshop on the transition to the new ATEX Directive 2014/34/EU held in Brussels on 30th September 2015.

¹⁴ <http://ec.europa.eu/DocsRoom/documents/13132/attachments/1/translations/en/renditions/native>

THE ARTICLES OF THE ATEX DIRECTIVE

CHAPTER 1 GENERAL PROVISIONS

§ 31 *General provisions*

General provisions of the ATEX Directive 2014/34/EU include articles on scope and definitions.

Article 1 **Scope**

1. This Directive shall apply to the following, hereinafter referred to as “products”:
 - (a) equipment and protective systems intended for use in potentially explosive atmospheres;
 - (b) safety devices, controlling devices and regulating devices intended for use outside potentially explosive atmospheres but required for or contributing to the safe functioning of equipment and protective systems with respect to the risks of explosion;
 - (c) components intended to be incorporated into equipment and protective systems referred to in point (a).
- ...

§ 32 *Products covered by the ATEX Directive*

The term "product" as defined in the ATEX Directive 2014/34/EU covers equipment, protective systems, safety devices, controlling devices, regulating devices and components.

To be within the scope of Directive, a product has to be:

- equipment or a protective system, as defined in Article 1(1)(a);
- a safety device, a controlling device or a regulating device as defined in Article 1(1)(b); or
- a component, as defined in Article 1(1)(c),

according to their intended use.

In some specific circumstances clarification is needed, in order to decide whether a certain product falls within the scope of Directive 2014/34/EU or not. This will be clarified using different examples:

- Inerting systems (see section [§ 241](#))
- Paint spray booths (see section [§ 242](#))

- Filter units and vented silo bins (see section [§ 243](#))
- Gas turbines (see section [§ 244](#))
- Steam turbines (see section [§ 245](#))
- Petrol pumps (see section [§ 246](#))
- Cables (see section [§ 247](#))
- Rotating mechanical seals (see section [§ 248](#))
- Bucket elevators (see section [§ 249](#))
- Fork lift trucks (see section [§ 250](#))
- Transportable, pressurised cabins ("modules") (see section [§ 251](#))
- Automatically lubricating systems (see section [§ 252](#))
- Electrical trace heating systems (see section [§ 253](#))
- Motor protection for category 3 motors (see section [§ 254](#))
- Wi-Fi access points (see section [§ 255](#))
- Refrigerators and storage cabinets for volatile substances (see section [§ 256](#))

Also, the "[Borderline list - ATEX products](#)" is useful to clarify the situation of a number of products (equipment, protective systems, components, safety controlling or regulating devices, and others) with respect to the ATEX Directive 2014/34/EU.

It has to be stressed that the ATEX Directive 2014/34/EU carries obligations and responsibilities for the person who places products on the market and/or puts products into service, be it the manufacturer, his authorised representative or any other responsible person. This "product" Directive does not regulate the use of equipment in a potentially explosive atmosphere which is covered by the ATEX "workplace" [Directive 1999/92/EC](#) and other similar European and national legislation (see *footnote 7 in the "Introduction"*).

The manufacturer, his authorised representative or the person who first places a product on the EU market or puts a product into service in the EU market has to decide whether it is covered by the ATEX Directive 2014/34/EU and, if so, apply its provisions. The manufacturer (in the broadest sense of the Directive) must therefore make an ATEX analysis on the basis of the Directive.

§ 33 Used, repaired or modified products and spare parts¹⁵

As a general rule, manufacturers need to consider whether the product is being placed onto the EU market or taken into service for the first time, or if the modifications are such that the intention or the result is to place a product onto the market, which has to be considered as a new product. If the answer to either of these questions is "yes", then Directive 2014/34/EU fully applies. In all other cases the Directive 2014/34/EU does not apply and the responsible person will have to ensure that any other relevant national or EU legislation are considered as appropriate.

Within this context two points should be made:

- In the following paragraphs, these Guidelines refer only to products for which Directive 2014/34/EU is potentially applicable. Products not subject to Directive 2014/34/EU are therefore excluded from these discussions.

¹⁵ The application of the ATEX Directive to "as-new equipment" is without any prejudice to intellectual property legislation. See Directive 89/104/EEC relating to the marks and the decision of the European Court of Justice of 11 July 1996, C427/93, 429/93, 436/93 Bristol Meyer Squibb.

- The application of Directive 2014/34/EU to an "as new" product is without any prejudice to intellectual property legislation¹⁶.

With regard to the information to be provided for repair of equipment, see section [§ 151](#) on instructions.

Used products and second hand products

In general terms, a "used product" is a product which has already been used; in this section, "used product" is intended as a product which has been placed on the EU market prior to the coming into force of Directive 2014/34/EU and put into service on the EU territory. This product was in compliance with the then applicable legislation: national or EU (as Directive 94/9/EC, applicable from 1 July 2003 to 19 April 2016), depending on the date. In this case Directive 2014/34/EU does not apply.

Used products that were on the market and used in the EU before the date of entry into force of Directive 2014/34/EU are not covered by it. These products have been marketed and used in accordance with the regulations in force at that time. They circulate in the European Union based, among others, on Articles 28 and 30 of the [Treaty on the Functioning of the European Union \(TFEU\)](#) concerning free movement of goods, unless they are modified so that health and safety characteristics have been affected.

For used products imported from a non-EU country and made available for the first time in the EU after 20 April 2016 for the purpose of distribution and/or use in the EU, Directive 2014/34/EU shall apply.

Reconditioned (or refurbished¹⁷) products

These are used products which were on the market and used in the EU but whose performance has changed over time (due to ageing, obsolescence, etc.), and which have been modified so as to be restored. The case of products whose external appearance has been modified and improved by a cosmetic or aesthetic operation after they have been placed on the market and put into service is a particular form of refurbishment aimed at restoring the external appearance of the product¹⁸. If this occurs with no substantial modification Directive 2014/34/EU does not apply.

Reconfigured products

These are used products which were on the market and used in the EU but whose configuration has been modified, by the addition (upgrading) or the removal (downgrading) of one or more parts (components, sub-assemblies such as plug-in

¹⁶ See Directive 89/104/EEC relating to the marks and the decision of the European Court of Justice of 11 July 1996 in joined cases C-427/93 and C-436/93 Bristol Meyer Squibb.

¹⁷ Both terms, reconditioned/refurbished, as well as reconditioning/refurbishment are used interchangeably in this section.

¹⁸ This can involve a modification of the electrostatic characteristics. The use of different materials or different external dimensions of the product might adversely change its ATEX performances. For example, a plastic enclosure may provide much lower electrostatic protection than a metallic enclosure.

cards or modules, etc.). If this occurs with no substantial modification Directive 2014/34/EU does not apply.

Substantially modified products

In the sense of Directive 2014/34/EU, a substantial modification is any modification to a product affecting one or more of the health and safety characteristics covered by essential health and safety requirements (e.g. temperature) or the integrity of a type protection. In this case Directive 2014/34/EU has to be applied. Of course this does not preclude the application of other relevant EU legislation, if it is the case.

According to the above, the general principle is that Directive 2014/34/EU re-applies to a modified product where the modification is considered to be substantial and if it is intended to be placed again on the EU market for distribution and/or use or to be used for own purposes.

Repaired products

These are products whose functionality has been restored following a defect without adding new features or any other modification. As this occurs after the product has been placed on the market and the product is not to be sold as a new product, in this case Directive 2014/34/EU does not apply.

This does not preclude that national regulations of the Member States on the working environment may require some kind of assessment of the repaired product as well.

Spare parts

These are items intended to replace a defective or worn out part of a product previously placed and put into service on the EU market. A typical repair operation would be replacement by a spare part.

The manufacturer of the spare part is normally not required to comply with Directive 2014/34/EU unless the spare part represents an item of equipment or a component as defined by the Directive. If so, all obligations laid down in the Directive have to be fulfilled.

If the manufacturer of the original spare part offers a new, different one in its place (due to technical progress, discontinued production of the old part, etc.), and it is used for the repair, the repaired product (as long as no substantial modification of the repaired product takes place) does not need to be brought into conformity at this time with Directive 2014/34/EU as the repaired product is not then placed on the market and put into service.

§ 34 Place of intended use

This point seeks to provide guidance on the place of installation of equipment and protective systems. In fact, manufacturers of explosion protected equipment (e.g. in cases where potentially explosive atmospheres are conveyed) sometimes feel unsure whether and to what extent their products are covered by Directive 2014/34/EU. This applies especially to cases where only parts of the equipment are in contact with the explosive atmosphere.

Directive 2014/34/EU deals with the special risk of explosion and has one major aim to prevent "own potential sources of ignition" (Article 2(1)) of equipment and protective systems (as far as it has its own potential source of ignition) from becoming active. Beside Article 1(2) no restrictions are made with regard to local and technical conditions.

The probability of occurrence of the potential source of ignition determines the category. The technical requirements are summarised in Annex II 1.0.1; especially the 2nd indent describes the importance of the potential of the source of ignition. For this effect the place of installation is not decisive (see Article 1(1)(b) safety-, controlling-, regulation devices), but the possible effect of the potential source of ignition on a potentially explosive atmosphere.

In the light of these ideas the place of installation "in, at or beside" a potentially explosive atmosphere is not decisive for the application of Directive 2014/34/EU. The decisive fact is whether the potential sources of ignition of equipment are in contact – or have an interface – to a potentially explosive atmosphere, with the effect that the combustion may spread to the entire unburned mixture (see definition "explosive atmosphere", Article 2(4)). In this case the potential source of ignition is in the potentially explosive atmosphere.

Equipment may have an internal explosive mixture (without limitation to dangerous quantities), which has an interface in the sense of a spreading of the combustion to a potentially explosive atmosphere even in the case it is not installed completely inside a potentially explosive atmosphere. An example could be an extraction system installed outside the potentially explosive atmosphere with a ventilator – own potential source of ignition – which exhausts explosive atmosphere out of a storage tank, or another potentially explosive atmosphere, via a pipe acting as connecting interface to the potentially explosive atmosphere.

It is important to underline in this context how machinery having a potentially explosive atmosphere inside under operating conditions, but having no interface to external potentially explosive atmospheres has to be considered. Such machines, as an integral whole, do not fall under scope of the ATEX Directive 2014/34/EU.

However, the essential health and safety requirement 1.5.7 "Explosion" in Annex I to the Machinery [Directive 2006/42/EC](#) (see section [§ 233](#)), requires that "*Machinery must be designed and constructed in such a way as to avoid any risk of explosion posed by the machinery itself or by gases, liquids, dust, vapours or other substances produced or used by the machinery. Machinery must comply, as far as the risk of explosion due to its use in a potentially explosive atmosphere is concerned, with the provisions of the specific Community [read 'Union'] Directives*" (see also the "[Guide to application of the Machinery Directive 2006/42/EC](#)", sections §§ 91 and 228).

It is therefore evident that equipment, protective systems and components intended for use *in this potentially explosive atmosphere* – and safety and controlling devices outside, but contributing to their safe functioning – are within the scope of the ATEX Directive 2014/34/EU. It is understood that the latter applies provided that "atmospheric conditions" in the sense of Directive 2014/34/EU are present in the machine.

In this context the following questions have arisen:

a) Has the manufacturer the obligation to perform a zone classification inside this machinery?

It has been considered that:

- the manufacturer of the machine has to carry out a risk analysis, including the risk of explosion;
- Annex I to the ATEX Directive 2014/34/EU contains clear and unambiguous definitions concerning the place where they are intended to be used for every single equipment-group and category;
- as opposed to the fully harmonising scope of the Machinery Directive, the zone concept applied in the framework of the ATEX "workplace" [Directive 1999/92/EC](#) allows Member States to apply more stringent requirements than those defined in this Directive.

In order to avoid a non-harmonised approach in the framework of a fully harmonised field like the Machinery Directive, it is not necessary to apply the *zone concept* as it is defined in Directive 1999/92/EC. Instead, the manufacturer should:

- carry out the risk assessment (the manufacturer could apply the harmonised standard EN 1127-1¹⁹ which describes the general concepts and methodology for explosion protection);
- define the requirements of the equipment to be used inside the potentially explosive atmosphere – and of safety and controlling devices outside, but contributing to their safe functioning – in order to ensure full compliance of the machinery with the requirements of the Machinery Directive;
- define the requirements for additional explosion protection measures (e.g. explosion-resistant design, autonomous protective system...) as a result of the risk assessment (e.g. for powder mills);
- purchase or produce the equipment having those requirements, i.e. intended to be used under the conditions defined during the risk analysis, and in conformity to Directive 2014/34/EU.

b) Must the "non-electrical" equipment used inside this machinery be also in conformity to 2014/34/EU?

The equipment used inside must be in conformity to the applicable legislation. When the original Machinery Directive 89/392/EEC was drafted, European Directives regulated only electrical equipment for use in potentially explosive atmospheres; therefore non-electrical equipment was not mentioned.

It is nevertheless a common understanding of the ATEX Committee that after the date of application of the previous ATEX Directive 94/9/EC (1 July 2003), both electrical and non-electrical equipment used in machinery having a potentially explosive atmosphere inside must comply with the ATEX Directive, now 2014/34/EU (from 20 April 2016). This position is also reflected in the Machinery Directive 2006/42/EC.

¹⁹ EN 1127-1:2019 Explosive atmospheres - Explosion prevention and protection - Part 1: Basic concepts and methodology

§ 35 Interface to different potentially explosive atmospheres

This point seeks to provide guidance on the application of the ATEX Directive 2014/34/EU to equipment²⁰ intended to operate with interfaces to different potentially explosive atmospheres.

At this point it is necessary to note that equipment that contains a potentially explosive atmosphere but is neither connected to, nor intended for use in, an external or process related potentially explosive atmosphere does not fall under the scope of Directive 2014/34/EU. However, any equipment inside this "container" will, so long as it fulfils the criteria for inclusion in scope, need to comply with the relevant provisions.

The categorisation of equipment is to be determined on the basis of the ignition risk assessment²¹ by the manufacturer or his authorised representative and the equipment's relationship with respect to its interface with its process atmosphere and any external atmosphere.

The following diagram illustrates this point:

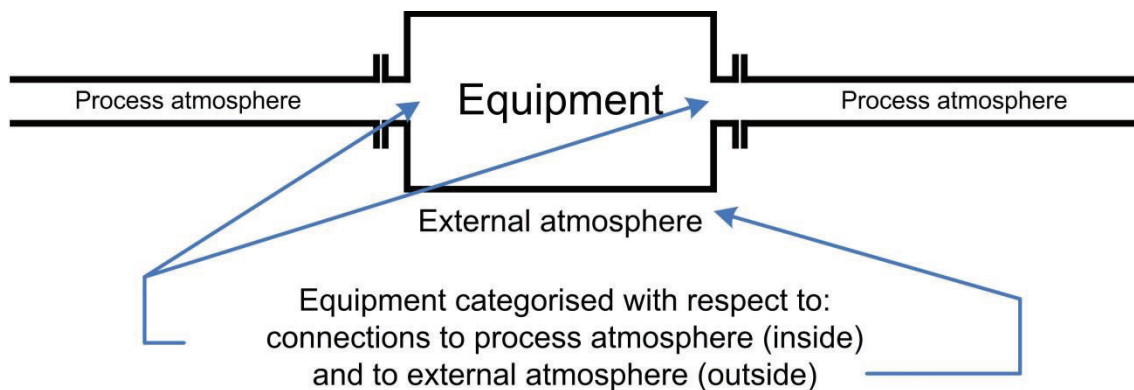

For example, the inside or process side of a pump for flammable liquid which normally runs full but occasionally contains an explosive atmosphere may, depending on the actual situation, be considered zone 1²² if no other measures have been taken to prevent the pump running dry. If it has been decided that the surroundings or external explosive atmosphere is zone 2 then a pump conforming to category 2 inside and category 3 outside must be used to meet the essential health and safety requirements of the Directive.

²⁰ Equipment here is taken to mean all products within scope of Directive 2014/34/EU.

²¹ The category classification is performed by the person responsible for making the EU declaration of conformity according to Directive 2014/34/EU.

²² "Zoning" is not a concept to be found in Directive 2014/34/EU but in Directive 1999/92/EC dealing with employer's obligations with respect to employees operating in hazardous atmospheres. It is not the responsibility of the manufacturer to "zone" but evidently this it is helpful to give an example of the area of intended use.

Note: the process atmosphere zone (and the respective category) needs not necessarily to be the same for the two connections to the process atmosphere.

The following guidelines may help in the selection of an appropriate category:

The ATEX category (or categories) assigned to equipment shall be determined for each part of the equipment which comes into contact with, or is connected to, a zone with a potentially explosive atmosphere (see [Directive 1999/92/EC](#)).

The category assigned to a piece of equipment intended to contain a potentially explosive atmosphere not connected to the outside of that equipment is determined by the ignition risk associated with the outside parts of the equipment, not by its internal atmosphere i.e. only the part of the equipment which is intended to come into contact with a zone is relevant for the assignment of the appropriate category.

The category (or categories) assigned to the process connecting points of equipment containing an explosive atmosphere cannot be higher than that appropriate to the ignition risk.

For example, consider the case of a fan conveying an explosive gas atmosphere over its rotating blades, or a powder mill producing an explosive dust atmosphere inside the mill. Each having an outlet connected to an external potentially explosive atmosphere. The ignition risk assessment for both these items of equipment has shown for these specific examples that an effective ignition source (for the explosive atmosphere connected to them) is not present in normal operation but may be present in the case of an expected malfunction. If such equipment/assembly is placed on the market without additional ignition protection or a protective system it can only be classified as category 3²³ (see section [§ 44](#) on combined equipment (assemblies)).

Such equipment can only be used when it is connected to an explosive atmosphere which is present continuously (i.e. zone 0/20) if additional ignition protection or a protective system is fitted (see Directive 1999/92/EC).

Where a piece of equipment is fitted with an autonomous protective system such as flame arresters, or a suppression system which is already compliant to Directive 2014/34/EU, additional testing and conformity assessment of the resulting assembly, i.e. equipment together with the protective system, is not required provided the protective system is used within its intended design capabilities covering the specific case, is installed in accordance with the manufacturer's instructions and no new ignition hazards are introduced. However, an ignition risk assessment will be required and relevant action taken if additional hazards are identified.

Similarly, Directive 2014/34/EU does not require that the pressure resistance of a vessel or container protected against the effects of an explosion by an autonomous protective system be tested, if it has been demonstrated that the autonomous

²³ Additional measures to cover expected malfunctions may provide category 2; if two faults or one rare fault are dealt with, category 1 can be reached.

protective system successfully detects and suppresses an explosion and if the vessel can withstand the residual pressure peak of the suppressed explosion.

Example

Note: The following is one of many examples that can be used to illustrate the above points. The assumptions made in this example should not be taken as the only possible situation. The categorisation of a particular piece of equipment will depend on the specific ignition hazard assessment that is made of the equipment and its intended use together with any ignition protection measures applied. The example only considers the inside and connecting explosive atmospheres, i.e. the process side. A separate ignition hazard assessment and categorisation must be made of the outside if the equipment is to be used in potentially explosive atmosphere.

Consider a powder mill as shown in the following scheme:

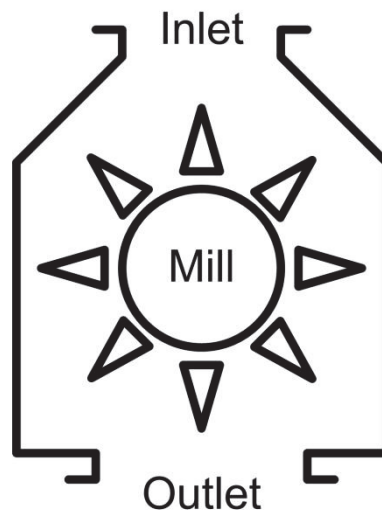

The ignition hazard assessment carried out by the manufacturer has identified that in this case:

- there is no ignition source inside the mill which can become effective in normal operation²⁴;
- there is an ignition source inside the mill which can become effective during expected malfunctions.

The highest category that can be assigned to the mill is therefore category 3 when it is placed on the market as shown. The outlet from the mill in this case produces fine dust in the form of a potentially explosive dust cloud which is continuously present in normal operation, i.e. category 1 is required. In cases when category 1 cannot be provided, the manufacturer has to take additional measures that the mill can be used safely, e.g. to provide an explosion-resistant design of the mill. If the explosion safety can be reached through additional explosion prevention or protection measures of the end-user, the manufacturer's instructions must therefore make clear that the mill can only be used with these additional measures.

²⁴ It is clear that for some milling technologies an ignition source may be unavoidable.

Analysis

Directive 2014/34/EU defines equipment as follows:

- intended for use in potentially explosive atmospheres;
- and/or for the processing of material;
- capable of causing an explosion through their own potential sources of ignition.

This definition applies to the grinding assembly of a mill for combustible materials of the food and fodder industry. Therefore, these are within the scope of Directive 2014/34/EU.

The intended purpose of a grinding assembly in a mill is the grinding of combustible materials whereby the content of fine particles is increased considerably.

According to the risk assessment the grinding installation should fulfil the requirements for category 1, but in the best case it will meet category 3. Despite all construction measures to prevent ignition sources, the occurrence of dust explosions cannot be excluded definitely. Therefore, the mill when fully installed must be provided with additional protection measures, which reduce the effect of a dust explosion for people and goods to below a dangerous level.

These measures are essential for the grinding system to fulfil the requirements of Directive 2014/34/EU.

Consequently:

- all requirements on the construction of the grinding assembly (*e.g. suitable selection of material and bearings, minimum distances between rotating and fixed parts*), on certain equipment of the mill (*e.g. foreign particles separator, overload protection, temperature detector at the bearings*)

and

- all construction measures of the mill (*explosion pressure resistant design for the maximum explosion pressure, or explosion pressure resistant design for the reduced explosion pressure in combination with explosion pressure relief or explosion suppression, and in most cases additional explosion decoupling for connected installations*)

are necessary to make the grinding operation safe.

§ 36 Safety devices, controlling devices and regulating devices as defined in Article 1(1)(b)

Devices in the scope of Article 1(1)(b) of the ATEX Directive 2014/34/EU

1. Safety devices, controlling devices and regulating devices intended for use outside potentially explosive atmospheres, but which are required for, or influence the safe functioning of equipment and protective systems, with respect to the risks of explosion, are also covered by the scope of the Directive.

Devices which influence the safe functioning of equipment and protective systems with respect to the risk of explosion can also be inside potentially explosive atmospheres. However if they are located within the explosive atmosphere, an additional risk assessment is required to take account of the risks of explosion for the

safety devices, controlling devices and regulating device (e.g. a safety device inside an enclosure type of protection 'd' or safety device may also comply with type of protection 'i').

Although the Directive does not explicitly say so, these devices can be designated as pieces of equipment in their own right.

2. These safety, controlling or regulating devices need be classified into categories, as required for the equipment within an explosive atmosphere, but identified by classification of the categories in brackets, e.g. "II (2) G" where the figure in brackets refers to the category of the equipment which is being influenced by the safety, controlling or regulating device.

3. If a safety instrumentation system (e.g. a sensor, PLC and an actuator, operating in one circuit) is considered, the entire system should be viewed as a safety device. Parts of this safety device may be located inside (e.g. a sensor) or outside (e.g. PLC) the potentially explosive atmosphere. The part located inside the potentially explosive atmosphere may have its own ignition risk and therefore must have its own verification in accordance to ignition risks and classification.

For such devices, the essential requirements shall only apply, so far as necessary, for their safe and reliable use with respect to the hazards of ignition (Annex II, Preliminary observation B).

Examples:

- Most electrical machines are protected against overload to prevent overheating. Usually the over-current device and/or the embedded temperature sensors plus control unit, switch off the electrical machine before the machine reaches a critical temperature. These safety devices shall fulfil, depending on the category of the machine, the requirements of "Safety devices required for the safe functioning of equipment with respect to explosion risks". A machine fed by a converter follows the same principles. In some cases the converter, or parts of the converter, could be seen as the safety device.
- Turbine pumps submerged in petrol tanks: a submersible turbine pump which is located inside the underground petrol storage tank is generally submerged in petroleum but may, from time to time, be partially or completely exposed to the explosive atmosphere that is present when the level of petrol drops below the level of the pump. Therefore the category of the pump is at least Category 2. A protection device shall ensure that the pump is submerged. Various means of achieving this are possible; for example a flow rate meter, a level gauge indicator or a load control device. The submerged pump could also be controlled by a Variable Frequency Speed Controller, typically located outside the hazardous area.
- Rotating Mechanical Seal: a rotating mechanical seal may create a hot surface due to friction. For category 2 equipment, a temperature monitoring device is necessary. If the manufacturer is putting the rotating mechanical seal on the market as equipment under the directive 2014/34/EU together with the monitoring system the latter has to be considered a safety device.

Devices outside the scope of Article 1(1)(b)

1. Devices other than safety, controlling and regulating devices.
2. All devices, including safety, controlling and regulating devices, neither contributing to nor required for the safe functioning with respect to the hazards of ignition or with respect to the hazard of uncontrolled explosion.
3. Even safety, controlling and regulating devices contributing to or required for the safe functioning but with respect to hazards other than the hazards of ignition or – respectively – with respect to the hazard of uncontrolled explosion.
4. Monitoring devices providing only an alarm signal to protect persons but without control of the equipment inside the hazardous area.
5. Monitoring system designed by an end-user and installed under his responsibility in order to implement some additional control (*) of ignition hazards on an equipment/installation according to the requirements of [Directive 1999/92/EC](#). In this case the end-user doesn't buy a complete safety instrumentation system but the various constituent parts of this system.

() Additional control means that this control is not mandatory according to the manufacturer's instructions or the relevant standards as EN 60079 series for this equipment.*

Examples:

- Switchgear, numeric controllers, etc. not related to any safety functions (with respect to the ignition hazard); see 2. above.
- Water spray systems designed to protect plant from fire.
- Blast doors designed to withstand a stated overpressure (these are designed primarily as doors, and they do no more than the walls they are placed in to protect against an explosion).
- Gas detector systems that raise an alarm but have no controlling function on the equipment.
- Emergency ventilation systems which act when gas is detected.

Article 1
Scope (continued)

...

2. This Directive shall not apply to:
 - (a) medical devices intended for use in a medical environment;
 - (b) equipment and protective systems where the explosion hazard results exclusively from the presence of explosive substances or unstable chemical substances;
 - (c) equipment intended for use in domestic and non-commercial environments where potentially explosive atmospheres may only rarely be created, solely as a result of the accidental leakage of fuel gas;

- (d) personal protective equipment covered by Council Directive 89/686/EEC of 21 December 1989 on the approximation of the laws of the Member States relating to personal protective equipment ⁽¹⁾;
- (e) seagoing vessels and mobile offshore units together with equipment on board such vessels or units;
- (f) means of transport, i.e. vehicles and their trailers intended solely for transporting passengers by air or by road, rail or water networks, as well as means of transport in so far as such means are designed for transporting goods by air, by public road or rail networks or by water. Vehicles intended for use in a potentially explosive atmosphere shall not be excluded from the scope of this Directive;
- (g) the equipment covered by point (b) of Article 346(1) of the Treaty on the Functioning of the European Union.

⁽¹⁾ OJ L 399, 30.12.1989, p. 18.

§ 37 Products excluded from the scope of the ATEX Directive

Exclusions based on Article 1(2) (a) to (g) of Directive 2014/34/EU are:

- a) medical devices intended for use in a medical environment;
- b) equipment and protective systems where the explosion hazard results exclusively from the presence of explosive substances or unstable chemical substances (see also footnote 28 in section [§ 41](#));
- c) equipment intended for use in domestic and non-commercial environments where potentially explosive atmospheres may only rarely be created, solely as a result of the accidental leakage of fuel gas. The question has also been discussed as to whether this implicitly conveys the meaning that equipment intended for use in domestic and non-commercial environments, where the leakage is not fuel gas, are included within scope. As a general rule such types of equipment are excluded from Directive 2014/34/EU as they are not intended for use in a potentially explosive atmosphere;
- d) personal protective equipment covered by Directive 89/686/EEC²⁵. There are occasions where personal protective equipment with its own potential sources of ignition is intended for use in potentially explosive atmospheres. This type of personal protective equipment should follow the procedures laid down in Directive 2014/34/EU to provide the necessary level of explosion safety (see also section [§ 235](#));

²⁵ Council Directive of 21 December 1989 on the approximation of the laws of the Member States relating to personal protective equipment (89/686/EEC) (OJ L 399, 30.12.1989, p. 18).

- e) seagoing vessels and mobile offshore units together with equipment on board such vessels or units, as they are already covered by the International Maritime Organisation (IMO) Conventions²⁶;
- f) means of transport, i.e. vehicles and their trailers intended solely for transporting passengers by air, road, rail or water networks, as well as means of transport in so far as such means are designed for transporting goods by air, by public road or rail networks or by water. Vehicles intended for use in a potentially explosive atmosphere are not excluded;
- g) the equipment covered by point (b) of Article 346(1) of the [Treaty on the Functioning of the European Union \(TFEU\)](#) concerning production of or trade in arms, munitions and war material for specifically military purposes, i.e. designed and manufactured specifically for use by the armed forces or in the maintenance of law and order. Dual-purpose equipment is not excluded.

The list in Article 1(2) is intended to be exhaustive concerning products explicitly excluded from the scope of Directive 2014/34/EU.

§ 38 Examples of equipment not covered by Directive 2014/34/EU

"Simple" products

For "simple" electrical products, European harmonised standards provide a good basis to assess the effectiveness of electrical ignition source and, consequently, to determine whether or not these can be considered effective or not.

In general, many "simple" mechanical products do not fall under the scope of Directive 2014/34/EU as they do not have their own source of ignition (*see section § 41 on "Own" ignition source*). Examples without their own source of ignition are hand tools such as hammers, spanners, saws and ladders (*see also the "Borderline list - ATEX products", pages 225-228*).

Other examples that in most cases have no potential ignition source are given below. However, the manufacturer will need to consider each item in turn with respect to potential ignition hazard to consider whether Directive 2014/34/EU applies:

- clockwork time pieces; mechanical camera shutters (metallic);
- pressure relief valves, self-closing doors;
- equipment moved only by human power, a hand operated pump, hand powered lifting equipment, hand-operated valves.

The issue of hand-operated valves has also been discussed. Given that these will move slowly, with no possibility of forming hot surfaces (*as discussed in section § 42 on non-electrical equipment*) they are not in scope of the Directive. Some designs incorporate polymeric parts, which could become charged, but this is no different from plastic pipes. Given that it is clear that the latter is outside of the scope of Directive 2014/34/EU it has been accepted that such valves do not fall within scope.

²⁶ See <http://www.imo.org/en/About/Conventions/ListOfConventions/Pages/Default.aspx>.

Some manufacturers have argued that their valves are specially adapted for ATEX, in that they have either selected more conductive polymers, or taken steps to ensure that no metal parts could become charged because they are unearthed. Other manufacturers state that all their valves meet this requirement simply by the way they are constructed, and they see no distinction from valves used to process non-flammable materials. To avoid confusion between those who claim correctly that their valves have no source of ignition, and are out of scope, and those who claim that they have done some very simple design change and wish to claim that their valves are now category 2 or even 1, it has been agreed that valves having characteristics as described above are out of scope. Nevertheless, where potentially flammable atmospheres exist, users must always consider the electrostatic ignition risks.

Installation

Installation is an entity which is made from parts previously considered separately but which are only put together at the point of application. They are different from assemblies which comprise parts previously considered separately, interconnected to create a combined product or assembly, to be placed on the market and/or put into service as a single functional unit (see section [§ 44](#) on combined equipment (assemblies)).

The ATEX Directive 2014/34/EU does not regulate the process of installation. Installing such (already ATEX-compliant) equipment at the end-user premises or under his responsibility will generally be subject to legal requirements either from the "workplace" directives (see footnote 7 in the "Introduction") or the domestic legislation of the Member States.

However, the question is frequently asked to distinguish between the responsibilities of manufacturers, building a piece of equipment or an assembly under the ATEX Directive 2014/34/EU and those responsibilities of an end user, buying in equipment parts to build an installation. (One might use the analogy of the difference between the manufacturing a discreet piece of equipment which can be placed on the market, such as a television – under the Low Voltage Directive 2014/35/EU, see section [§ 232](#) –, and equipping a house with all its utilities built into which a range of products will be installed and connected, this would clearly be an installation and come under the "workplace" [Directive 89/391/EEC](#)²⁷ or other directives concerning workplace safety.)

A common situation is that pieces of already ATEX-compliant equipment are placed on the market independently by one or more manufacturer(s), and are not placed on the market by a single legal person as a single functional unit (as described in section [§ 44](#) on combined equipment (assemblies) which are fully specified configuration of parts). Combining such equipment and installing at the user's premises is not considered as manufacturing and thus does not result in equipment; the result of such an operation is an installation and is outside the scope of Directive 2014/34/EU. The installer has to ensure that the initially compliant pieces of equipment still comply when they are taken into service. For that reason he has to carefully follow all installation instructions of the manufacturers. The Directive does not regulate the

²⁷ Council Directive 89/391/EEC of 12 June 1989 on the introduction of measures to encourage improvements in the safety and health of workers at work (OJ L 183, 29.6.1989, p. 1).

process of installation. Installing of ATEX-compliant equipment will generally be subject to legal requirements of the Member States. An example could be instrumentation consisting of a sensor, a transmitter, a Zener barrier and a power supply if provided by several different manufacturers installed under the responsibility of the user.

It is understood that there is not always a clear line between an installation and an assembly.

For assemblies and installations the responsibilities will either fall on the person who places the assembly on the market, or the end-user. Each must draw up a technical file setting out how they have complied with the relevant legislation. Much of the technical content will be the same.

The result, this is to say, the installation of equipment in a plant, will usually not to be a "product" under the ATEX Directive 2014/34/EU if:

- the end-user, or an installer purchases parts (including ATEX equipment and installation materials) from different manufacturers and they are installed under his responsibility after a full risk assessment has been undertaken;
- the user carries out a whole series of different processes requiring the integration of ATEX-compliant equipment and parts on site, and they are installed according to a unique layout;
- the end-user commissions the building of parts of his installation off-site, which may be unique, but certainly not a production run, and which is done under his direct responsibility, or indirectly through a contractor, working under contract to him;
- commissioning tests or adjustments are needed once the plant is built and are carried out under the final responsibility of the end user.

Article 2
Definitions

For the purposes of this Directive, the following definitions shall apply:

...

§ 39 Definitions

The definitions in Article 2 of the ATEX Directive 2014/34/EU include those specific to the scope of the Directive as well as the general ones of the [New Legislative Framework](#), from [Decision No 768/2008/EC](#).

Article 2
Definitions (continued)

...

- (1) 'equipment' means machines, apparatus, fixed or mobile devices, control components and instrumentation thereof and detection or prevention systems which, separately or jointly, are intended for the generation, transfer, storage, measurement, control and

conversion of energy and/or the processing of material and which are capable of causing an explosion through their own potential sources of ignition;

...

§ 40 Equipment

Equipment; as defined in the ATEX Directive 2014/34/EU, means machines, apparatus, fixed or mobile devices, control components and instrumentation thereof and detection or prevention systems which, separately or jointly, are intended for the generation, transfer, storage, measurement, control and conversion of energy and/or the processing of material and which are capable of causing an explosion through their own potential sources of ignition.

It should be noted that intrinsically safe electrical equipment is included in the scope of the Directive.

§ 41 "Own" ignition source

A defining element of equipment in the sense of the Directive is that it has to have its own potential source of ignition.

Potential sources of ignition could be: electric sparks, arcs and flashes, electrostatic discharges, electromagnetic waves, ionising radiation, hot surfaces, flames and hot gases, mechanically generated sparks, optical radiation, chemical flame initiation²⁸, compression.

In some cases a product may only contain a potentially explosive atmosphere which is deliberately ignited. It is clearly not the intention that these fall under the scope of Directive 2014/34/EU unless other relevant hazards exist. Most equipment made to the Gas Appliances Directive 2009/142/EC will fall into this category (see [section § 238](#)).

Equipment can be said to have its own potential source of ignition, if, when operated as intended (including malfunctions, etc. to an extent depending on its category – see Annex I to the Directive) in a potentially explosive atmosphere, it is capable of igniting the latter unless specific safety measures are taken. Therefore, equipment must ensure the required level of protection.

To ensure this required level of protection various techniques can be applied, e.g.: intrinsic safety, pressurisation, increased safety, etc.

Many common items are made from plastics (polymers) with very low electrical conductivity. These can become charged, e.g. if they are rubbed, or if dust or a liquid flows over the surface. However, in most cases this may be controlled by the user, and if they are used in hazardous areas it shall be assessed and controlled according to the requirements of relevant national or Union legislation (e.g. [Directive](#)

²⁸ Account needs to be taken of the specific exclusion at Article 1(2)(b) of the Directive 2014/34/EU of equipment where explosion hazards result exclusively from the presence of explosive substances or unstable chemical substances.

[1999/92/EC](#)). In any case the user of such equipment has to consider these ignition sources when undertaking a risk assessment in the workplace. Examples are plastic containers used for transporting chemicals, polyethylene pipes, buckets and chairs.

If the only source of electrostatic charging comes from the process, such items are not considered to have their own source of ignition, and they are not in scope of Directive 2014/34/EU. In these cases they should not be Ex or CE marked according to Directive 2014/34/EU.

If the polymeric item is intended to be incorporated into ATEX equipment, and could become charged by the movement of the equipment (for example a fan blade) or by the intended use of the equipment, they may be classed as ordinary parts of the equipment with specific properties (e.g. to be electrostatically dissipative) or as ATEX components if they are placed on the market specifically for this intended use.

§ 42 Non-electrical equipment

If non-electrical equipment has a potential ignition source, in most cases this is due to moving parts able to create a potential ignition risk either from hot surfaces, or friction sparks. Examples are: gears, fans, pumps, compressors, mixers, brakes. Mechanical equipment of this type usually has to be connected to a power source, such as an electric motor. Together placed on the market in this form, it might be an assembly (see section [§ 44](#) on combined equipment (assemblies)).

Mechanical equipment may be fitted with a thermocouple or similar measuring device that generates only very low voltages and currents. If these measuring devices can be considered as "simple apparatus" (as described in section [§ 38](#)) and there are no other electrical parts, the equipment should follow the conformity assessment procedures for non-electrical equipment. If the equipment contains electrical apparatus that can be clearly separated, the conformity assessment procedure for non-electrical parts can be made separately if the conditions described for electrical equipment (e.g. pump) apply (see section [§ 43](#)). If the electrical equipment fitted to the non-electrical equipment is not "simple apparatus", the product is usually considered as an assembly.

All potential ignition sources should be considered for equipment that is within the scope. For a list of potential ignition sources, see the relevant harmonised standards for equipment. In many cases the equipment will also be machinery within the scope of [Directive 2006/42/EC](#) (see section [§ 233](#)).

Some mechanical items move very slowly, or have very low power input. Such equipment may be incapable of forming hot surfaces or other ignition sources, even in cases of rare malfunction. The manufacturer should assess if such equipment is potentially capable of igniting an explosive atmosphere, and if it is not, it shall not be classed as ATEX equipment nor be marked according to Directive 2014/34/EU.

§ 43 Electrical equipment

Directive 2014/34/EU does not specifically define "electrical equipment". However, because such equipment is subject to its own conformity assessment procedure it

may be useful to provide a definition, which has been generally accepted by the majority of Member States.

In this sense, electrical equipment can be considered as equipment containing electrical elements, used for the generation, storage, measurement, distribution and conversion of electrical energy, for controlling the function of other equipment by electrical means or for processing materials by the direct application of electrical energy. It should be noted, that a final product assembled using both electrical and mechanical elements may not require assessment as electrical equipment provided the combination does not lead to additional ignition hazards for this assembly.

§ 44 Combined equipment (assemblies)

From the term "jointly" in the definition of equipment in the Directive (Article 2(1)) it follows that a product, formed by combining two or more pieces of equipment, together with components if necessary and together with other parts as necessary, that are electrically and mechanically interconnected to create a complete functional assembly, has to be considered as a product falling under the scope of Directive 2014/34/EU. This combined product or assembly must be placed on the market and/or put into service by a responsible person (who will then be the manufacturer of that assembly) as a single functional unit.

Such assemblies may not be ready for use but require proper installation. The instructions (Annex II, 1.0.6.) shall take this into account in such a way that compliance with Directive 2014/34/EU is ensured without any further conformity assessment provided the installer has correctly followed the instructions.

In the case of an assembly consisting of different compliant pieces of equipment as defined by Directive 2014/34/EU which were previously placed on the market by different manufacturers these items of equipment have to conform with the Directive, including being subject to proper conformity assessment, CE-marking, etc. The manufacturer of the assembly may presume conformity of these pieces of equipment and may restrict his own risk assessment of the assembly to those additional ignition and other relevant hazards (as defined in Annex II) which become relevant because of the final combination. If there are additional ignition hazards, a further conformity assessment of the assembly regarding these additional risks is necessary. Likewise, the assembler may presume the conformity of components which are accompanied by a written attestation of conformity issued by their manufacturer (Article 6(2)) (see also section [§ 74](#) on obligations of manufacturers).

However, if the manufacturer of the assembly integrates parts without CE marking into the assembly (because they are parts manufactured by himself or parts he has received from his supplier in view of further processing by himself) or components not accompanied by the written attestation of conformity, he shall not presume conformity of those parts and his conformity assessment of the assembly shall cover those parts as required.

Note that the manufacturer's own risk assessment does not necessarily preclude the use of notified bodies in the applicable conformity assessment procedure(s).

In order to clarify the concept of "assembly" in the sense of Directive, a pump/electric motor combination intended for use in potentially explosive atmospheres can be used as an example.

1. For the purposes of Directive 2014/34/EU, a split tube motor pump constitutes a single item of equipment with respect to the ignition hazard, i.e. the pump and electric motor cannot be considered separately for the purposes of assessing explosion risk(s). In this case, the unit as a whole has to undergo the conformity assessment procedure of electrical equipment. The same applies e.g. for an electrical ventilating fan where the fan is an integral part of the motor.

2. a) In some cases the pump and electric motor can be considered separately although they form a functional unit. If in this case there is no additional ignition hazard as a result of assembling the pump and motor, this functional unit as a whole does not constitute a single item of equipment which falls within the scope of Directive 2014/34/EU. It is then to be considered a combination of "individual items of equipment" in terms of explosion protection. In this case, therefore, the manufacturer of pump and electrical motor must supply an EU declaration of conformity for each of both items.

2. b) A manufacturer may nevertheless choose to supply pump and motor as described in 2. a) with one EU declaration of conformity for the assembly as a whole. In this case further clarification is required as to the obligation of the assembler where only ATEX compliant products (such as equipment and autonomous protective systems) are used. Here it is clear that the assembler needs to undertake an ignition risk assessment to ensure that the nature of the incorporation and assembly has not altered the explosion characteristics of the products with respect to the essential health and safety requirements of the Directive. If the assembler is in any way uncertain as to how to undertake such an assessment, technical advice should be sought and taken into account. This might be the case, for example, if a manufacturer of mechanical equipment needs to connect different pieces of ATEX electrical equipment together as part of the assembly. Once the assembler has successfully undertaken such an assessment and no additional ignition risk has been identified, the general agreement is that he then draws up a technical file, affixes the CE and Ex marking according to Annex II 1.0.5 of the Directive to the assembly, indicating intended use, signs the EU declaration of conformity covering the whole of the assembly indicating the technical specifications/ standards applied (for example, for electrical inter-connection) and provide instructions for safe use. The assembler therefore takes complete responsibility for the assembly. This procedure does not require the involvement of a notified body.

2. c) If there is an additional ignition hazard as a result of assembling pump and motor, or if one item is not already in full conformity with the Directive, the assembly has to undergo the complete conformity assessment procedure appropriate for the category.

Assemblies may be placed on the market in different ways: with specified configurations of parts or with various configurations.

Combined products (assemblies) which are fully specified configurations of parts

In this case the manufacturer has already defined one or more invariable combination(s) of parts and places them on the market as a single functional unit / single functional units.

An example could be instrumentation consisting of a sensor, a transmitter, a Zener barrier and a power supply if provided by one manufacturer.

The above mentioned parts are put together by the same person (the manufacturer of the assembly), and placed on the market as a single functional unit. This person assumes responsibility for the compliance of the combined product with the Directive.

The EU declaration of conformity, as well as the instructions for use must refer to the assembly as a whole. It must be clear (e.g. by enclosing a list of all parts and/or a list of the safety related data) which is/are the combination(s) that form(s) the assemblies. The manufacturer assumes responsibility for compliance with the Directive, and must therefore, in accordance with Annex II 1.0.6, provide clear instructions for assembly/installation/operation/maintenance etc. in the instructions for use.

Combined products (assemblies) with various configurations

In this case the manufacturer has defined a whole range of different parts, forming a "modular system". Either he or the user/installer selects and combines parts out of this range to form an assembly, which serves the specific task.

An example could be a modular system for flameproof switch- and control gear, consisting of a range of flameproof enclosures of different size, a range of switches, terminals, circuit breakers etc.

Although in this case the parts are not necessarily put together by the manufacturer of the assembly, and placed on the market as a single functional unit, the manufacturer is responsible for the compliance of the assembly as long as the parts are chosen from the defined range and selected and combined according to his instructions.

The EU declaration of conformity, as well as the instructions for use must refer to the "modular system" as a whole. It must be clear which the parts that form the modular system are, and how they are to be selected to form a compliant assembly. Therefore the manufacturer must, in accordance with Annex II 1.0.6, provide clear instructions for selection of parts and their assembly/installation /operation/maintenance etc. in the instructions for use. The conformity assessment of such modular systems may be done (as a minimum) by means of the assessment of those intended configurations which are the most unfavourable regarding the relevant risks (worst cases). If those configurations are considered compliant to the essential health and safety requirements of Directive 2014/34/EU the manufacturer may conclude conformity of all other intended configurations as well. If later on other parts are to be added to the "modular system" it may of course become necessary to identify and assess the worst case scenario again.

The **Table 1: Summary of requirements for combined products (assemblies)**, on the following page, gives a condensed overview of the various situations regarding assemblies and their requirements under the ATEX Directive 2014/34/EU.

Table 1: Summary of requirements for combined products (assemblies) under the ATEX Directive 2014/34/EU

<p>SITUATION: 1. Parts: Assembly is composed of...</p>	<p>Equipment, protective systems, devices (Article 1(1)) all CE-marked (accompanied by an EU declaration of conformity) and components accompanied by a written attestation of conformity (Article 13(3)) (parts with proven conformity) (*)</p>	<p>Equipment, protective systems, devices (Article 1(1)), including non CE-marked, and components not accompanied by a written attestation of conformity (Article 13(3)) (parts without proven conformity)</p>	<p>Exactly defined configuration(s)</p>
<p>2. Configuration: Assembly is placed on the market as...</p>	<p>Exactly defined configuration(s)</p>	<p>A "modular system" of parts, to be specifically selected and configured to serve a specific purpose, maybe by the user/installer.</p>	<p>A "modular system" of parts, to be specifically selected and configured to serve a specific purpose, maybe by the user/installer.</p>
<p>3. RESULT: Manufacturer may presume conformity for...</p>	<p>All parts</p>	<p>All parts</p>	<p>Only parts with proven conformity</p>
<p>4. Conformity assessment</p>	<p>Conformity assessment has to cover the whole configuration regarding all risks, which might arise by the interaction of the combined parts, with respect to the intended use. <i>See also Note (*)</i></p>	<p>Conformity assessment has to cover at least those of the possible and useful configurations, which are assessed to be the most unfavourable regarding all risks, which might arise, by the interaction of the combined parts, with respect to the intended use. <i>See also Note (*)</i></p>	<p>Conformity assessment has to cover: - all parts without proven conformity which are part of the "modular system", regarding all risks, and - at least those of the possible and useful configurations, which are assessed to be the most unfavourable regarding all risks which might arise by the interaction of the combined parts, both with respect to the intended use.</p>
<p>5. Information to be provided: a) by EU declaration of conformity b) by instructions for installation and use</p>	<p>a) identification of the items in the assembly that are ATEX equipment in their own right, and which have been separately assessed; b) instructions for installation and use, sufficient to ensure that resulting assembly complies with all relevant EHSRs of Directive 2014/34/EU.</p>	<p>a) identification of the items in the assembly that are ATEX equipment in their own right, and which have been separately assessed; b) instructions for the selection of parts, to be combined to fulfil the required purpose, and instructions for installation and use, sufficient to ensure that resulting assembly complies with all relevant EHSRs of Directive 2014/34/EU.</p>	<p>a) identification of the items in the "modular system" that are ATEX equipment in their own right, and which have been separately assessed; b) instructions for the selection of parts, to be combined to fulfil the required purpose, and instructions for installation and use, sufficient to ensure that resulting assembly complies with all relevant EHSRs of Directive 2014/34/EU.</p>

(*) Note: A written attestation of conformity for a component cannot guarantee, in general, the safety of the equipment into which the component is to be incorporated, as for a component, all possible use cannot be foreseen. In this case, further investigation and evaluation by a notified body shall be carried out in the assembly, when required.

Article 2
Definitions (continued)

...

- (2) 'protective systems' means devices other than components of equipment which are intended to halt incipient explosions immediately and/or to limit the effective range of an explosion and which are separately made available on the market for use as autonomous systems;

...

§ 45 Protective systems

According to the definition in the ATEX Directive 2014/34/EU, examples of autonomous protective systems are:

- flame arresters;
- explosion relief systems (using e.g. bursting discs, vent panels, explosion doors, etc.);
- extinguishing barriers;
- explosion suppression systems.

It is clear that certain simple products used in coal mines act as protective systems but cannot be subject to the provisions of the Directive (e.g. inert stone dust on planks).

From its intended function it is obvious that a protective system will, at least partially, be installed and used in a potentially explosive atmosphere.

Because a protective system has the function to eliminate or reduce the dangerous effects of an explosion (a safety function) it is subject to the Directive regardless as to whether it has its own potential source of ignition or not. In this first case it would have to comply with the specific essential health and safety requirements for equipment as well.

According to Article 2(2) protective systems are placed on the market separately for use as autonomous systems. Consequently their conformity with the relevant essential health and safety requirements of Annex II has to be assessed according to Article 13(2) and they have to be marked according to Article 16.

Of course "protective systems" may also be placed on the market as an integral part of equipment. Technically speaking these remain "protective systems" because of their function, but are not considered as autonomous protective systems in the sense of the Directive regarding conformity assessment and marking. In such cases their conformity is assessed in the course of the conformity assessment of the equipment they are integrated into, using the procedures foreseen in Article 13 according to the group and category of that equipment. They are not separately marked.

It is, however, important to note that the specific essential health and safety requirements of section 3 of Annex II also apply for integrated "protective systems".

Article 2
Definitions (continued)

(3) 'components' means any item essential to the safe functioning of equipment and protective systems but with no autonomous function;

...

§ 46 Components

The two defining elements for components are that:

- they are essential to the safe functioning of equipment and protective systems with respect to explosion protection (otherwise they would not need to be subject to the Directive);
- they have no autonomous function (otherwise they would have to be regarded either as equipment, protective system or as device according to Article 1(1)(b)).

A product is considered to have an autonomous function if it can be safely used to deliver, or contribute towards the delivery of, one or more of the intended functions of Article 1, without the need to add any further parts. This does not preclude that specific instructions for installation and use are to be followed.

Some kinds of products may, depending on the extent of the conformity assessment already undertaken before being placed on the market and/or put into service, be considered either as with or without autonomous function.

If the function of the product can be delivered without further parts then, where relevant, it cannot be considered a component.

Components intended for incorporation into equipment or protective systems which are accompanied by a written attestation of conformity including a statement of their characteristics and how they must be incorporated into products (see Article 13(3)), are considered to conform to the applicable provisions of Directive 2014/34/EU. Ex-components as defined in the European standards harmonised under Directive 2014/34/EU are components in the sense of the ATEX as well.

Components must not have the CE marking affixed unless otherwise required by other EU harmonisation legislation (e.g. the Electromagnetic Compatibility [Directive 2014/30/EU](#) – see section [§ 231](#)).

Examples for items which could be placed on the market as components, if they are explicitly intended to be incorporated into ATEX products, are the following:

- terminals;
- push button assemblies;
- relays;
- empty flameproof enclosures;
- ballasts for fluorescent lamps;
- encapsulated relays and contactors, with terminals and/or flying leads;

- machinery brakes designed to be part of ATEX equipment;
- a pressurised container including suppressant powder forming part of an explosion suppression system;
- conveyor belting for a conveyor transporting combustible dusts;
- non-autonomous protective systems;
- suction hoses used on vacuum cleaners;
- forks for forklift trucks.

According to Article 13(3) the conformity of components has to be assessed by means of the same procedures as the equipment, protective systems or devices according to Article 1 into which they are to be integrated. Some components may be assigned a category, in which case they will always be used in equipment of that category. Other components may be more widely used, and no category can be defined. In addition, components for e.g. autonomous protective systems do not need to bear a category as the protective systems themselves are not categorised. It depends on the detail that is given in any documentation provided (e.g. where relevant by means of a written attestation of conformity).

For example, drive-belts, bearings, mechanical seals, Zener diodes, etc. that are not usually placed on the market with the explicit intention to be incorporated into equipment, protective systems or devices according to Article 1(1)(b) but for general engineering purposes, are not to be seen as components. Their conformity (i.e. their suitability for the intended purpose as regards safety of the product they are integrated into) has to be assessed in the course of the conformity assessment of the integral product.

If components are to be placed on the market with the explicit intention of incorporation into equipment, protective systems or devices according to Article 1(1)(b) (as e.g. increased safety terminal blocks, flameproof enclosures, etc.), they shall be assessed separately according to Article 13(3) and either accompanied by a written attestation of conformity as referred to in Article 13(3), or the attestation of conformity shall be made accessible to all customers by cross-media documentation e.g. QR-codes with reference to internet, electronic catalogues, web-link on the package unit or delivery papers, etc.

The obligations for manufacturers established in Article 6(2) and (8) concerning accompanying documents for products (EU declaration of conformity or attestation of conformity, instructions and safety information) could be not proportionate and even problematic for components. In fact, components often are very small items supplied in a wide range of batch sizes and package quantities, with the possibility of small delivery quantities associated with enormous quantities produced and large possible variances installed in the final end user application (device). In this sense, an alternative means of satisfying the information obligation is a reference to be provided in the delivery documentation or on the smallest additional packaging to a website or other source from which the information can be obtained. Such sources of information may include:

- a) a link to the manufacturer's website in plain text on each packaging unit or on the delivery documentation;
- b) cross-media information (such as a QR code or a radio-frequency identification chip) on each packaging unit or in the delivery documentation that links to a database or provides the required data directly.

Otherwise, Member States can prohibit, restrict or impede their placing on the market (Article 5) and cannot presume their conformity (Article 12(1)).

If a component is subject to a conformity assessment procedure under which a notified body issues an EU-type examination certificate, the certificate must detail those requirements of Annex II that have been assessed.

§ 47 *Difference between equipment and components. Specific requirements given in the manual of products*

It is the obligation of manufacturers, importers or authorized representatives to follow the requirements for products within the scope of the Directive, when they are placing these products on the market. For some products the involvement of a notified body is required: both, manufacturer and notified body, have to consider whether a product is equipment or component. Any equipment and its instructions must meet the essential health and safety requirements of the Directive. It is the obligation of the manufacturer to issue instructions, which can include so-called "specific conditions of use". These specific conditions of use cannot specify additional safety measures which have to be part of the manufacturing process or are part of the type testing by a notified body.

If it is not possible for the end-user to fulfil the requirements given as "specific conditions of use" because they are too general, a product does not meet the requirements of the Directive. The manufacturer and the notified body, if involved, have to bear in mind, that the users normally do not have the detailed knowledge or the needed test equipment. Therefore it should not happen that specific conditions of use will not result in a product complying with the requirements of the Directive. The complete safety evaluation of equipment has to be done by the manufacturer based on his responsibility for the equipment. With his EU declaration of conformity the manufacturer attests the full compliance with the ATEX Directive. The use of such equipment must not create dangerous situations. The manufacturer is responsible for the foreseeable misuse if the user is not able to fulfil the specific conditions for use correctly.

It is the clear aim of the ATEX Directive that only safe products are being placed on the EU market. Products, which have to undergo additional verification acts, are components. These components cannot be transferred into equipment by creating non-dischargeable "specific conditions for use". With the manual the manufacturer has to prescribe the details, how it will be possible for the user to fulfil the specific conditions of use. If the user has to add items such as an enclosure, the user will act as a manufacturer.

The main differences between equipment and components can be shown in the following **Table 2: Equipment and components according to Directive 2014/34/EU**.

Table 2: Equipment and components according to Directive 2014/34/EU

Equipment	Components
<p>Definition in the ATEX Directive 2014/34/EU, Article 2(1): 'equipment' means machines, apparatus, fixed or mobile devices, control components and instrumentation thereof and detection or prevention systems which, separately or jointly, are intended for the generation, transfer, storage, measurement, control and conversion of energy and/or the processing of material and which are capable of causing an explosion through their own potential sources of ignition</p>	<p>Definition in the ATEX Directive 2014/34/EU, Article 2(3): 'components' means any item essential to the safe functioning of equipment and protective systems but with no autonomous function</p>
<p>All aspects and requirements of explosion protection according to Annex II to Directive 2014/34/EU have to be fulfilled.</p>	<p>Components must be so designed and constructed that they function safely for their intended purpose of explosion protection when they are installed in accordance with the manufacturer's instructions (Annex II, 1.2.2).</p>
<p>The equipment is marked according to the ATEX Directive, marked with the CE marking and accompanied by a) the EU declaration of conformity, and b) instructions for use.</p>	<p>The component is marked according to the ATEX Directive <u>but not marked with the CE marking</u>, and is accompanied by a) a written attestation of conformity, and b) instructions for assembling.</p>
<p>The equipment is ready for use based on the instructions for use of the manufacturer and installation requirements.</p>	<p>The component is <u>not ready for use</u>. The final conformity assessment of the component is done together with the assessment of the complete equipment, in/with which the component will be fixed or installed.</p>
<p>Definition of the standard EN IEC 60079-0:2018:</p> <p><i>3.31 Equipment</i> General term including apparatus, fittings, devices, components, and the like used as a part of, or in connection with, an installation.</p> <p><i>3.12.2 Ex Equipment Certificate</i> A certificate prepared for Ex Equipment.</p> <p><i>3.84 Symbol "X"</i> Suffix to the certificate number used to denote specific conditions of use for Ex Equipment. NOTE: The symbol "X" is used to provide a means of identifying that essential information for the installation, use, and maintenance of the equipment is contained within the certificate.</p>	<p>Definition of the standard EN IEC 60079-0:2018:</p> <p><i>3.26 Ex Component</i> Equipment intended to be a part of Ex Equipment, marked with the symbol "U", which is not intended to be used alone and requires additional consideration when incorporated into Ex equipment.</p> <p><i>3.12.1 Ex Component Certificate</i> A certificate prepared for an Ex Component.</p> <p><i>3.83 Symbol "U"</i> Suffix to the certificate number used to denote an Ex Component NOTE: The symbol "U" is used to identify that the equipment is incomplete and is not suitable for installation without further evaluation.</p>

§ 48 Examples and problems on equipment and components

a) Panel

A product with open terminals is placed on the market as category 3 equipment. In the instructions the following "special condition of use" requires: *"The use of this equipment needs an enclosure of at least IP65. The equipment has to be mounted in an area with a lower risk of mechanical impact"*.

This product is a component because it is incomplete (missing enclosure) and further actions (e.g. test), considerations and information are necessary for safe use.

The manufacturer has to consider the following topics:

1. IP 65 alone is not sufficient to make clear the requirements of Annex II of the Directive 2014/34/EU. The enclosure has to fulfil also the requirements of Annex II and the EN 60079-0.
2. The meaning of "low risk of mechanical impact" is unclear. The manufacturer has to specify the details to fulfil this special condition.
3. It is not sufficient to use any enclosure to protect the equipment against impact.

The same questions arise for similar category 2 equipment certified by a Notified Body.

b) Switch

In an EU-type examination certificate for a category 2 switch, the following "special condition of use" was found: *"The mechanical test according EN 60079-0:2006, clause 26.4.1.2 and the impact test according clause 26.4.2 were not done with this switch. A similar protection technique has to be used for an installation in hazardous areas"*.

This special condition of use is not allowable, because further tests are required, which have to be done by a notified body. Therefore this product is to be regarded a component.

c) Empty Ex-'d' enclosure

An Ex-'d' empty enclosure was certified as category 2 equipment with a "special condition of use", describing how to drill the holes for cable entry devices by a notified body. During the EU-type examination, the manufacturer showed the notified body an assembled enclosure. But the manufacturer sold the enclosures without assembling them.

This product is a component because part of the production process of assembling has to be covered by the quality assessment of the manufacturer and must not be part of the installation.

If the manufacturer allows machining works (e.g. drilling holes) done by the user, he is nevertheless responsible for the final product. Normally this machining work is part of the quality assessment done by a notified body. In case of drilling holes into an Ex-'d' enclosure this assessment for the machining work would be necessary but is not done by the user.

After drilling the holes and mounting the cable entries or other devices, additional tests of the applicable standards could be necessary, such as flame transmission and pressure tests according to EN 60079-1.

Another problem can be the maximum surface temperature. The assessment of maximum surface temperature and of the temperature behaviour inside of the enclosure is the responsibility of the manufacturer and the notified body involved.

Article 2
Definitions (continued)

...

- (4) 'explosive atmosphere' means a mixture with air, under atmospheric conditions, of flammable substances in the form of gases, vapours, mists or dusts in which, after ignition has occurred, combustion spreads to the entire unburned mixture;
- (5) 'potentially explosive atmosphere' means an atmosphere which could become explosive due to local and operational conditions;

...

§ 49 Explosive atmosphere and potentially explosive atmosphere

Equipment is only considered to be within the scope of the ATEX Directive 2014/34/EU if it is intended (either in whole or in part) to be used in a potentially explosive atmosphere.

If a product containing an intended potentially explosive atmosphere, for example a vessel, itself contains equipment as defined in the Directive, then the latter equipment is in effect in a potentially explosive atmosphere, albeit one which is contained by the vessel, and is therefore subject to the Directive.

If equipment containing a potentially explosive atmosphere can, due to its construction, operation etc. create a potentially explosive atmosphere itself, which wholly or partially surrounds it, then such equipment is in effect in a potentially explosive atmosphere, and is therefore subject to the Directive.

A third scenario is that there may not only be a surrounding potentially explosive atmosphere but also a process that requires such a mixture to enter and/or be released from the product. The interface between the equipment and the process input/output will also require consideration. This may lead, in some cases, to equipment having more than one category, one (or more) for the external atmosphere and another for the process atmosphere.

§ 50 Potentially explosive atmosphere in the sense of Directive 2014/34/EU

Directive 2014/34/EU is a directive following the "New Approach" and the [New Legislative Framework](#) and therefore is intended to enable the free movement of goods within the EU. This is achieved by harmonisation of legal safety requirements,

following a risk-related approach. Its objective is also to eliminate or at least minimise the risks resulting from the use of certain products in or in relation to a potentially explosive atmosphere. The manufacturer has to make assumptions about the intended use of his product including the contact with potentially explosive atmospheres.

An explosive atmosphere for the purposes of Directive 2014/34/EU is defined as a mixture

- i) of flammable substances in the form of gases, vapours, mists or dusts;
- ii) with air;
- iii) under atmospheric conditions²⁹;
- iv) in which, after ignition, the combustion spreads to the entire unburned mixture (It has to be noted that sometimes (mainly with dusts) not always the whole quantity of the combustible material is consumed by the combustion).

An atmosphere which could become explosive due to local and/or operational conditions, is called a potentially explosive atmosphere. It is only this kind of potentially explosive atmosphere which products falling under the ATEX Directive 2014/34/EU are designed for.

It is important to note that products are not covered by Directive 2014/34/EU where they are intended for use in or in relation to mixtures which might potentially be explosive, but one or more of the defining elements i) to iv) above are not present. For example:

- A product within a potentially explosive mixture without the presence of air is not in the scope of the Directive³⁰. Special processes of this type require equipment that has been specially designed for the risks, as equipment intended for use in potentially explosive atmospheres may pose an ignition hazard for mixtures under non-atmospheric conditions.
- Conveying equipment where some parts but not all are under atmospheric pressure with internal pressures different from atmospheric pressure can fall under the scope of Directive 2014/34/EU. When performing a risk assessment it will become evident that although parts of the described equipment are outside the scope of Directive 2014/34/EU during normal operation (pressure oscillates between too low and too high values in relation to "atmospheric conditions") some parts or spaces still are under the scope and that the whole equipment during start-up and shut-down is under the scope, at least.

²⁹ Directive 2014/34/EU does not define atmospheric conditions. However, a surrounding temperature range of –20 °C to 60 °C and a range of pressure between 0.8 bar and 1.1 bar may be appropriate as a basis for design and intended use of products. This does not preclude that products may be specifically designed and assessed for operation occasionally outside these conditions. It should be noted that electrical products are normally designed and tested for use in the ambient temperature range –20 °C to 40 °C in conformity with the harmonised standards. Products designed for use outside of this range will require additional marking to be added and further testing as appropriate. This will normally require agreement between the manufacturer and the intended user.

³⁰ Examples for such atmospheres could be: mixtures which are explosive without air (e.g. H₂ mixed with Cl₂), mixtures of flammable substances with other oxidants than air, pressure and/or temperature conditions outside the atmospheric range, etc.

So, both the following examples fall under the scope of Directive 2014/34/EU:

- a) A vapour recovery pump for petrol stations is connected at its inlet and outlet to a potentially explosive atmosphere in the sense of Directive 2014/34/EU.
- b) A vacuum pump sucking from a vacuum container and conveying the mixture into a pressure vessel or pressure line is in scope of Directive 2014/34/EU just during starting and shutting down phases. In this case the inner parts of the pump are connected to a potentially explosive atmosphere in the sense of Directive 2014/34/EU.

Note: The manufacturer may wish to sell this equipment for use under atmospheric conditions of the inlet and outlet side additionally, and then case a) applies. In any case, the complete working cycle needs to be considered, including start-up and shut-down, which may cause an atmospheric pressure to exist. If the equipment is not intended for atmospheric use, the Directive does not apply. Risk assessment must be carried out according to [Directive 1999/92/EC](#).

As long as the user is not able to ensure the absence of a potentially explosive atmosphere, start-up and shut-down are relevant to determine the application of the Directive.

Article 2
Definitions (continued)

...

- (6) 'equipment-group I' means equipment intended for use in underground parts of mines, and in those parts of surface installations of such mines, liable to be endangered by firedamp and/or combustible dust, comprising equipment categories M 1 and M 2 as set out in Annex I;
- (7) 'equipment-group II' means equipment intended for use in other places liable to be endangered by explosive atmospheres, comprising equipment categories 1, 2 and 3 as set out in Annex I;
- (8) 'equipment category' means the classification of equipment, within each equipment group, specified in Annex I, determining the requisite level of protection to be ensured;

...

§ 51 Equipment group and category

The ATEX Directive 2014/34/EU divides equipment into groups and categories. Annex I defines the criteria determining the classification of equipment-groups and categories (see sections [§§ 133-138](#)).

Article 2
Definitions (continued)

...

- (9) 'intended use' means the use of a product prescribed by the manufacturer by assigning the equipment to a particular equipment group and category or by providing all the information which is required for the safe functioning of a protective system, device or component;

...

§ 52 Intended use

Intended use means either the use for which the equipment is intended in accordance with the information provided by the person placing it on the market, or the ordinary use as determined by the design and construction of the product.

Manufacturers have to match a level of protection for the users of the equipment which corresponds to the use that the manufacturer prescribes for the equipment in the product information, under the conditions of use which can be reasonably foreseen. This is particularly relevant in the cases where misuse of the equipment is possible/likely – even if ATEX equipment is normally used by trained operators.

The consequence for manufacturers is that they have to consider the conditions of use which can be reasonably foreseen prior to placing equipment on the market.

Manufacturers have to look beyond what they consider the intended use of the equipment and place themselves in the position of the average user of a particular product and envisage in what way they would reasonably consider to use the product.

See also § 2.7. "Intended use / Misuse" in ["The 'Blue Guide' on the implementation of EU product rules"](#).

Article 2
Definitions (continued)

...

- (10) 'making available on the market' means any supply of a product for distribution, consumption or use on the Union market in the course of a commercial activity, whether in return for payment or free of charge;

...

§ 53 Making available on the market

A product is made available on the market when supplied for distribution, consumption or use on the Union market in the course of a commercial activity, whether in return for payment or free of charge. The concept of making available refers to each individual product.

"Making available" means the transfer of the product, that is, either the transfer of ownership, or the physical hand-over of the product by the manufacturer, his authorised representative in the EU or the importer to the person responsible for distributing these onto the EU market or the passing of the product to the final consumer, intermediate supplier or user in a commercial transaction, for payment or free of charge, regardless of the legal instrument upon which the transfer is based (sale, loan, hire, leasing, gift, or any other type of commercial legal instrument). The ATEX product must comply with the Directive at the moment of transfer.

See also § 2.2. "Making available on the market" in "[The 'Blue Guide' on the implementation of EU product rules](#)".

Article 2
Definitions (continued)

...

- (11) 'placing on the market' means the first making available of a product on the Union market;

...

§ 54 Placing on the market

A product is placed on the market when it is made available for the first time on the European Union market, against payment or free of charge, for the purpose of distribution and/or use in the EU territory.

Products made available on the market must comply with the applicable Union harmonisation legislation at the moment of placing on the market.

See also § 2.3. "Placing on the market" in "[The 'Blue Guide' on the implementation of EU product rules](#)".

Article 2
Definitions (continued)

...

- (12) 'manufacturer' means any natural or legal person who manufactures a product or has a product designed or manufactured, and markets that product under his name or trade mark or uses it for his own purposes;

...

§ 55 Manufacturer

For the obligations of manufacturers, see section [§ 74](#).

According to the definition, the manufacturer may design and manufacture the product itself, or alternatively may use bought-in items, third-party subcontractor services or components, CE marked or not, to assist in the manufacture of the product.

Whoever substantially modifies a product resulting in an "as-new" product, such that its health and safety characteristics (and/or performance) are in any way affected, with a view to placing it on the EU market or using it for his own purpose, also becomes the manufacturer.

As long as the end-user only uses a product and does not manufacture it, he is not a manufacturer according to the definition of the Directive. Using products also includes the integration of already ATEX-compliant products by the end-user in his plant after having performed a full risk assessment including occupational safety items, interfaces and interactions to the existing plant, according to [Directive 1999/92/EC](#).

From the above, it follows that such an integration, which is unique and considers the well-known purposes and specific conditions of operation of the plant, will not fall into the scope of the Directive.

Example:

The integration of a pump, a clutch, an engine, the mounting plate, and a level indicator as a run dry protection system by the end-user in a plant considering the parameters of the conveyed media and the conditions of operation is an installation.

See also § 3.1. "Manufacturer" in ["The 'Blue Guide' on the implementation of EU product rules"](#).

Article 2
Definitions (continued)

...

- (13) 'authorised representative' means any natural or legal person established within the Union who has received a written mandate from a manufacturer to act on his behalf in relation to specified tasks;

§ 56 Authorised representative

For the obligations of authorised representatives, see section [§ 80](#).

An authorised representative is the person or persons expressly appointed by the manufacturer by a written mandate to act on his behalf in respect of certain manufacturer's obligations within the EU. The extent to which the authorised representative may enter into commitments binding on the manufacturer is restricted

by the relevant Articles of the Directive and determined by the mandate conferred on him by the latter.

As an example, he could be appointed to undertake the testing in the EU territory, sign the EU declaration of conformity, affix the CE marking and hold the EU declaration of conformity and the technical documentation within the EU at the disposal of the competent authorities.

The quality assessment system of the authorised representative/responsible person shall not be subject to assessment by a notified body, but the quality assessment system of the actual manufacturer. It would not be reasonable to assess a quality assessment system of a facility that is not producing the product. However, if the authorised representative is carrying out tests and/or verifications required by the Directive to determine conformity with the essential health and safety requirements, he shall be subject to quality assurance assessment.

See also § 3.2. "Authorised representative" in "[The 'Blue Guide' on the implementation of EU product rules](#)".

Article 2
Definitions (continued)

...

(14) 'importer' means any natural or legal person established within the Union who places a product from a third country on the Union market;

...

§ 57 Importer

For the obligations of importers, see section [§ 81](#).

The importer is the economic operator established in the EU who places a product from a third country on the Union market.

See also § 3.3. "Importer" in "[The 'Blue Guide' on the implementation of EU product rules](#)".

Article 2
Definitions (continued)

...

(15) 'distributor' means any natural or legal person in the supply chain, other than the manufacturer or the importer, who makes a product available on the market;

...

§ 58 Distributor

For the obligations of distributors, see section [§ 82](#).

The distributor is a natural or a legal person in the supply chain, other than the manufacturer or the importer, who makes a product available on the market.

See also § 3.4. "Distributor" in "[The 'Blue Guide' on the implementation of EU product rules](#)".

Article 2
Definitions (continued)

...

(16) 'economic operators' means the manufacturer, the authorised representative, the importer and the distributor;

...

§ 59 Economic operators

The [New Legislative Framework](#) as in [Decision No 768/2008/EC](#) defines the manufacturer, the authorised representative, the importer and the distributor as "economic operators".

Article 2
Definitions (continued)

...

(17) 'technical specification' means a document that prescribes technical requirements to be fulfilled by a product;

...

§ 60 Technical specification

This is a very general concept that includes different kinds of technical requirements for products or categories of products, according to applicable legislation and/or to sectoral provisions. Technical specifications can be provided by standards or any other technical document drafted by authorised experts as well as by public or private organisations. They can establish a "minimum" as "essential requirements" or can be more detailed in terms of specific technical solutions for design and manufacturing of a product.

Since the New Approach calls for common essential requirements to be made mandatory by legislation, this approach is appropriate only where it is possible to

distinguish between essential requirements (see section [§ 71](#)) and technical specifications.

Article 2
Definitions (continued)

...

(18) 'harmonised standard' means harmonised standard as defined in point (c) of point (1) of Article 2 of Regulation (EU) No 1025/2012;

...

§ 61 Harmonised standard

The ATEX Directive 2014/34/EU provides manufacturers with the option of complying with its requirements by designing and manufacturing directly in accordance with the essential health and safety requirements of the Directive, or to European harmonised standards which are developed specifically to allow a presumption of conformity with those requirements.

The lists of references of European standards harmonised under Directive 2014/34/EU are available on <http://ec.europa.eu/growth/single-market/european-standards/harmonised-standards/equipment-explosive-atmosphere/>.

See also section [§ 86](#) on presumption of conformity of products.

Article 2
Definitions (continued)

...

(19) 'accreditation' means accreditation as defined in point 10 of Article 2 of Regulation (EC) No 765/2008;

(20) 'national accreditation body' means national accreditation body as defined in point 11 of Article 2 of Regulation (EC) No 765/2008;

...

§ 62 Accreditation and national accreditation body

Accreditation is the attestation by a national accreditation body that a conformity assessment body meets the requirements set by harmonised standards and, where applicable, any additional requirements including those set out in relevant sectoral schemes, to carry out a specific conformity assessment activity.

It is based on the international standards for conformity assessment bodies that have been harmonised in the [New Legislative Framework](#) and the references of which

have been published in the Official Journal of the European Union (OJEU). With [Regulation \(EC\) No 765/2008](#), only national accreditation bodies are allowed to provide accreditation of conformity assessment bodies.

Accreditation is to be operated as a public authority activity and is to be provided on a not-for-profit basis.

Each EU Member State may appoint one single national accreditation body. The responsibilities and tasks of the national accreditation body have to be clearly distinguished from those of other national authorities.

Within the EU, accreditation bodies are not allowed to compete with other accreditation bodies. They are only to be active on the territory of their own Member State.

See also § 6. "Accreditation" in ["The 'Blue Guide' on the implementation of EU product rules"](#).

Article 2
Definitions (continued)

...

(21) 'conformity assessment' means the process demonstrating whether the essential health and safety requirements of this Directive relating to a product have been fulfilled;

(22) 'conformity assessment body' means a body that performs conformity assessment activities including calibration, testing, certification and inspection;

...

§ 63 Conformity assessment

As for the other EU legislative acts under the "New Approach" and the [New Legislative Framework](#) covering products, two important elements of the ATEX Directive 2014/34/EU are:

- the legislative requirements governing the characteristics of the products covered, and
- the conformity assessment procedures the manufacturer carries out in order to demonstrate that a product, before it is placed on the market, conforms to these legislative requirements.

Conformity assessment is the process carried out by the manufacturer of demonstrating whether specified requirements relating to a product have been fulfilled.

A product is subjected to conformity assessment both during the design and production phase. Conformity assessment is the responsibility of the manufacturer.

Should a manufacturer subcontract design or production, he still remains responsible for the execution of conformity assessment.

The essential objective of a conformity assessment procedure is to demonstrate that products placed on the market conform to the requirements expressed in the provisions of the relevant legislation.

Conformity assessment bodies (notified bodies under the ATEX Directive 2014/34/EU) provide the professional and independent judgements, which consequently enable manufacturers or their authorised representatives to fulfil the procedures in order to presume conformity to the Directive. Their intervention is required:

- for issuing of EU-type examination certificates, and for inspection, verification and testing of equipment, protective systems, devices and components before they can be placed on the market and/or put into service;
- for the assessment of manufacturer's quality assurance system in the production phase.

See also § 5. "Conformity assessment" in "[The 'Blue Guide' on the implementation of EU product rules](#)".

Article 2
Definitions (continued)

...

(23) 'recall' means any measure aimed at achieving the return of a product that has already been made available to the end-user;

(24) 'withdrawal' means any measure aimed at preventing a product in the supply chain from being made available on the market;

...

§ 64 Recall and withdrawal

Competent national authorities must take action to enforce conformity, when they discover that a product is not in compliance with the provisions of the Directive.

Enforcement of conformity can be achieved by obliging the manufacturer, the authorised representative, or other responsible persons, to take required measures.

In case of formal non-compliance the market surveillance authority should first oblige the manufacturer, or the authorised representative, to make the product intended to be placed on the market and if necessary, the product already on the market, comply with the provisions and to remedy the infringement.

See also § 7.4.5. "Corrective measures - bans - withdrawals - recalls" in "[The 'Blue Guide' on the implementation of EU product rules](#)".

Article 2
Definitions (continued)

...

- (25) 'Union harmonisation legislation' means any Union legislation harmonising the conditions for the marketing of products;

...

§ 65 Union harmonisation legislation

Harmonisation legislation issued by the European Union, for products in the single internal market, is mainly made by Regulations and Directives.

Article 2
Definitions (continued)

...

- (26) 'CE marking' means a marking by which the manufacturer indicates that the product is in conformity with the applicable requirements set out in Union harmonisation legislation providing for its affixing.

§ 66 CE marking

See also sections [§§ 144-145](#) on marking and CE marking.

As a general rule, "New Approach" and [New Legislative Framework](#) legislation, including the ATEX Directive 2014/34/EU, provide for the affixing of the CE marking as part of the conformity assessment procedures in the perspective of total harmonisation.

Where a product is subject to several directives or regulations, which all provide for the affixing of CE marking, by affixing the CE marking the manufacturer indicates that the product conforms to the provisions of all these directives and regulations.

The CE marking is mandatory and must be affixed before any equipment or protective system is placed on the market or put into service. As stated in Article 13(3) components are excluded from this provision. Instead of being CE marked, components have to be delivered with a written attestation (*see section [§ 46](#) on components*) stating the conformity with the provisions of the Directive, stating their characteristics and indicating how they must be incorporated into equipment or protective systems. This separate statement goes along with the definition of components, which have as structural parts no autonomous function.

Article 3

Making available on the market and putting into service

1. Member States shall take all appropriate measures to ensure that products may be made available on the market and put into service only if, when properly installed and maintained and used in accordance with their intended use, they comply with this Directive.
2. This Directive shall not affect Member States' entitlement to lay down such requirements as they may deem necessary to ensure that persons and, in particular, workers are protected when using relevant products provided that this does not mean that such products are modified in a way not specified in this Directive.
3. At trade fairs, exhibitions and demonstrations, Member States shall not prevent the showing of products which do not comply with this Directive, provided that a visible sign clearly indicates that such products do not comply with this Directive and that they are not for sale until they have been brought into conformity by the manufacturer. During demonstrations, adequate safety measures shall be taken to ensure the protection of persons.

§ 67 Making available on the market and putting into service

A product is made available on the market when supplied for distribution, consumption or use on the Union market in the course of a commercial activity, whether in return for payment or free of charge. This concept of "making available" refers to each individual product.

The concept of "placing on the market" is directly related to "making available" in the sense that a product is placed on the market when it is made available for the first time on the Union market. Products made available on the market must comply with the applicable Union harmonisation legislation at the moment of placing on the market.

"Putting into service" takes place at the moment of first use of a product within the Union by the end-user.

§ 68 Making available ATEX products on the market

"Making available" means the transfer of the product, that is, either the transfer of ownership, or the physical hand-over of the product by the manufacturer, his authorised representative in the EU or the importer to the person responsible for distributing these onto the EU market or the passing of the product to the final consumer, intermediate supplier or user in a commercial transaction, for payment or free of charge, regardless of the legal instrument upon which the transfer is based (sale, loan, hire, leasing, gift, or any other type of commercial legal instrument). The ATEX product must comply with Directive 2014/34/EU at the moment of transfer.

§ 69 Placing ATEX products on the market

The concept of "placing on the market" determines the moment when products pass for the first time from the manufacturing stage to the market of the EU or the importing stage from a non-EU country to that of distribution and/or use in the EU.

Since the concept of placing on the market refers only to the first time products are made available in the EU for the purpose of distribution and/or use in the EU, the ATEX Directive 2014/34/EU covers only:

- a) new products manufactured within the EU,
- b) "as-new" products (*according to section § 55*),
- c) new or used products imported from a non-EU country,
- d) new or "as-new" products labelled by a person who is not the original manufacturer.

The Directive's provisions and obligations concerning placing on the market apply as by 20 April 2016 to each product individually and are irrespective of the date and place of manufacturing. It is the manufacturer's responsibility to ensure that each and all of his products comply where they fall under the scope of the Directive.

As the EU harmonisation legislation applies to all form of supply, if a manufacturer, his authorised representative in the EU or the importer offers products covered by the ATEX Directive 2014/34/EU in a catalogue or by means of electronic commerce, such products have to comply with the Directive when the catalogue or website directs its offer to the EU market and includes an ordering and shipping system. Products offered for sale online by sellers based outside the EU are considered to be placed on the EU market if sales are specifically targeted at EU consumers or businesses.

The placing of products on the market does not concern:

- the disposal of products from the manufacturer to his authorised representative established in the EU who is responsible on behalf of the manufacturer for ensuring compliance with the Directive;
- imports into the EU for the purpose of re-export, i.e., under the processing arrangements;
- the manufacture of products in the EU for export to a non-EU country;
- the display of products at trade fairs and exhibitions. These may not be in full conformity with the provisions of the Directive 2014/34/EU, but this fact must be clearly advertised next to the products being exhibited.

The person placing the product on the EU market, be it the manufacturer, his authorised representative or, if neither of them is established in the EU, the importer or any other responsible person, must retain at the disposal of the competent authority the EU declaration of conformity. The technical documentation has to be made available on request of the enforcement authorities within a reasonable time (see Annexes III, VI, VIII to the Directive). These documents shall be maintained by such a person at the disposal of the competent authorities for ten years after the last item has been manufactured. This applies to products manufactured in the EU as well as those imported from a non-EU country.

§ 70 Putting ATEX products into service

It is the first use of products referred to in Directive 2014/34/EU in the EU territory, by its end user. Products covered by Directive 2014/34/EU are put into service at the moment of first use.

However, for a product which is ready for use as soon as it is placed on the market and which does not have to be assembled or installed, and where the distribution conditions (storage, transport, etc.) makes no difference to the performance or safety characteristics of the product with reference to the essential health and safety requirements of Directive 2014/34/EU, it will not be necessary to verify again compliance with Directive 2014/34/EU at the time they are put into service. Products manufactured for own use will have to comply with the essential health and safety requirements of Directive 2014/34/EU at the time they are first used by the end user.

See also §§ 2.2. "Making available on the market", 2.3. "Placing on the market" and 2.5 "Putting into service or use (and installation)" in "[The 'Blue Guide' on the implementation of EU product rules](#)".

Article 4

Essential health and safety requirements

Products shall meet the essential health and safety requirements set out in Annex II which apply to them, account being taken of their intended use.

§ 71 Essential health and safety requirements

A fundamental feature of the ATEX Directive 2014/34/EU, as for other Union harmonisation legislation, is to limit legislative harmonisation to the essential health and safety requirements (EHSRs) that are of public interest. These requirements deal with the protection of health and safety of users (e.g. consumers and workers) but may also cover other fundamental requirements (for example protection of property, scarce resources or the environment).

The ATEX essential health and safety requirements are set out in Annex II of the Directive, although no detailed manufacturing specifications are included. Such technical specifications can be provided for by standards, in particular European harmonised standards (voluntary) use of which confers presumption of conformity with the relevant requirements.

See also § 4.1 "Essential product requirements" in "[The 'Blue Guide' on the implementation of EU product rules](#)".

Article 5

Free movement

Member States shall not prohibit, restrict or impede the making available on the market and putting into service in their territory of products which comply with this Directive.

§ 72 Free movement

The objective of eliminating trade barriers among the EU Member States and of strengthening the free movement of products is stated by a free movement clause, inserted in the ATEX Directive 2014/34/EU, which guarantees the free movement of

products complying with the legislation. Therefore, Member States cannot impede the making available on the market of a product which complies with all the provisions of the Directive.

See also § 8. "Free movement of products within the EU" in "[The 'Blue Guide' on the implementation of EU product rules](#)".

CHAPTER 2 OBLIGATIONS OF ECONOMIC OPERATORS

§ 73 Obligations of economic operators

Chapter 2 of the ATEX Directive 2014/34/EU deals with obligations and identification of manufacturers, authorised representatives, importers and distributors, collectively defined as "economic operators". Those are the "active parts" in the supply chain when a product is placed on the EU market and in this sense, specific obligations and responsibilities are defined. It should be noted that users (consumers, workers...) are not considered as "economic operators" with respect to the Directive.

See also § 3. "The actors in the product supply chain and their obligations" in "[The 'Blue Guide' on the implementation of EU product rules](#)".

Article 6 Obligations of manufacturers

1. When placing their products on the market or using them for their own purposes, manufacturers shall ensure that they have been designed and manufactured in accordance with the essential health and safety requirements set out in Annex II.

2. Manufacturers shall draw up the technical documentation referred to in Annexes III to IX and carry out the relevant conformity assessment procedure referred to in Article 13 or have it carried out.

Where compliance of a product, other than a component, with the applicable requirements has been demonstrated by that procedure, manufacturers shall draw up an EU declaration of conformity and affix the CE marking.

Where compliance of a component with the applicable requirements has been demonstrated by the relevant conformity assessment procedure, manufacturers shall draw up a written attestation of conformity as referred to in Article 13(3).

Manufacturers shall ensure that each product is accompanied by a copy of the EU declaration of conformity or of the attestation of conformity, as appropriate. However, where a large number of products is delivered to a single user, the batch or consignment concerned may be accompanied by a single copy.

3. Manufacturers shall keep the technical documentation and the EU declaration of conformity or, where applicable, the attestation of conformity for 10 years after the product has been placed on the market.

4. Manufacturers shall ensure that procedures are in place for series production to remain in conformity with this Directive. Changes in a product design or characteristics and changes in the harmonised standards or in other technical specifications by reference to which conformity of a product is declared shall be adequately taken into account.

When deemed appropriate with regard to the risks presented by a product, manufacturers shall, to protect the health and safety of end-users, carry out sample testing of products made available on the market, investigate, and, if necessary, keep a register of complaints, of non-conforming products and product recalls, and shall keep distributors informed of any such monitoring.

5. Manufacturers shall ensure that products which they have placed on the market bear a type, batch or serial number or other element allowing their identification, or, where the size or nature of the product does not allow it, that the required information is provided on the packaging or in a document accompanying the product.

6. Manufacturers shall ensure that products, other than components, which they have placed on the market bear the specific marking of explosion protection and, where applicable, the other markings and information referred to in point 1.0.5 of Annex II.

7. Manufacturers shall indicate, on the product, their name, registered trade name or registered trade mark and the postal address at which they can be contacted or, where that is not possible, on its packaging or in a document accompanying the product. The address shall indicate a single point at which the manufacturer can be contacted. The contact details shall be in a language easily understood by end-users and market surveillance authorities.

8. Manufacturers shall ensure that the product is accompanied by instructions and safety information in a language which can be easily understood by end-users, as determined by the Member State concerned. Such instructions and safety information, as well as any labelling, shall be clear, understandable and intelligible.

9. Manufacturers who consider or have reason to believe that a product which they have placed on the market is not in conformity with this Directive shall immediately take the corrective measures necessary to bring that product into conformity, to withdraw it or recall it, if appropriate. Furthermore, where the product presents a risk, manufacturers shall immediately inform the competent national authorities of the Member States in which they made the product available on the market to that effect, giving details, in particular, of the non-compliance and of any corrective measures taken.

10. Manufacturers shall, further to a reasoned request from a competent national authority, provide it with all the information and documentation in paper or electronic form necessary to demonstrate the conformity of the product with this Directive, in a language which can be easily understood by that authority. They shall cooperate with that authority, at its request, on any action taken to eliminate the risks posed by products which they have placed on the market.

§ 74 Obligations of manufacturers

For the definition of manufacturer, see section [§ 55](#).

On the basis of obligations stated in the ATEX Directive 2014/34/EU, the manufacturer bears responsibility for:

- undertaking an analysis to conclude if the product is subject to the Directive and which requirements apply (*as explained in section [§ 32](#)*);
- design and construction of the product in accordance with the essential health and safety requirements laid down in the Directive;
- following the procedures for the assessment of the conformity of the product with the essential health and safety requirements laid down in the Directive (see Article 13);
- signing the EU declaration of conformity or the written attestation of conformity;
- providing marking and instructions for safe use, maintenance etc. as described in Annex II to the Directive.

The manufacturer has sole and ultimate responsibility for the conformity of the product to the applicable Union legislation. The manufacturer must understand both the design and construction of the product to be able to declare such conformity in respect of all applicable provisions and requirements of the relevant Union legislation.

For the purposes of market surveillance the EU declaration of conformity and, when applicable, the written attestation of conformity must accompany the information given with each single product, or each batch of identical products delivered for the same end user. These documents, as well as the translations according to the language requirements in national legislations transposing the Directive, need to be provided on paper, in a similar way as for safety information that also must accompany the product according to the ATEX Directive. While safety information needs to be provided in paper copy, the other non-safety instructions can be provided on electronic or other data storage format. However, a paper version should always be available upon request and free of charge for the market surveillance authorities and the end-users.

Articles 12 to 16 and their associated annexes of the Directive 2014/34/EU define the obligations incumbent on the manufacturer with regard to conformity assessment, CE marking, the EU declaration of conformity, the written attestation of conformity (if relevant) and the arrangements for holding the EU declaration of conformity, together with the technical documentation, at the disposal of the competent authorities for a period of 10 years after the last product has been manufactured.

See also § 3.1. "Manufacturer" in "[The 'Blue Guide' on the implementation of EU product rules](#)".

§ 75 Use of subcontractor services by a manufacturer

The manufacturer may have the product designed, manufactured, assembled, packaged, processed or labelled by subcontractors, with a view to placing the product on the market under its own name, and thus presenting itself as the manufacturer, disregarding its involvement in the physical/actual manufacturing processes.

Where subcontracting of this type takes place, the manufacturer must retain the overall control for the product and ensure that the manufacturer receives all the

information that is necessary to fulfil the responsibilities of a manufacturer according to the Directive.

In such cases, the manufacturer cannot discharge itself from its responsibilities as a manufacturer, as it is responsible for the application of relevant conformity assessment procedures, including engaging a notified body where required to do so by the Directive, for example to approve and carry out periodic surveillance of the manufacturer's quality management system.

§ 76 *Manufacturers and conformity assessment based on quality assurance (Annex IV, Annex VII)*

Due to the use of subcontractors, the manufacturer may not be able to demonstrate (to a notified body) that its own quality assurance system ensures the product complies with the requirements of the Directive. The quality assurance of the production process (Annex IV) or the product quality assurance (Annex VII) systems at the actual manufacturing plant premises, of the manufacturer itself and/or of subcontractors, need to be the subject of an assessment by a notified body, including periodic audit visits.

The manufacturer may not rely on the notified body audits of the third-parties to discharge its responsibilities under the Directive. The notified body shall not issue the subcontractor with a quality assurance notification for this purpose, unless the subcontractor holds its own EU-type examination certificate for the same product.

In case a manufacturer A uses a subcontractor B for the production or labelling of a product, which places the same product on the market under its own name, it is sufficient for the manufacturer to apply for a second certificate based on the certificate of the subcontractor. The manufacturer will be expected to submit

- the original certificate,
- a declaration by the original manufacturer that the equipment to be produced under the name of the trade agent will be identical with the originally certified equipment,
- a declaration by the trade agent that the equipment brought to the market will be identical to that originally certified, and
- a copy of the contractual agreement between the manufacturer A and the subcontractor B.

§ 77 *Certificates and CE marking without the name of the original manufacturer*

Different possible cases are dealt with in this section.

Case 1: Authorised representative

The manufacturer applies for assessment and the certificate, if granted, is in the name of the manufacturer.

The EU declaration of conformity and the application of the CE marking may be effected either by the manufacturer or his authorised representative, but not by both. Required marking shall show the manufacturer's name and the number of the notified body involved in the manufacturer's production phase shall appear be placed after the CE marking.

Any person who is not an authorised representative is not allowed to issue an EU declaration of conformity or to apply the CE marking.

An authorised representative is assimilated with and regarded as an extension of the manufacturer's operation. The name of the manufacturer shall be on the rating plate.

Case 2: "De facto" manufacturer

Any person who is not the manufacturer may apply for assessment and, if successful, have the certificate granted in his name and puts his name on the rating plate provided he can satisfy the chosen notified body that he is fully responsible and has control over the design of the saleable product.

Irrespective of where the product is manufactured, he can issue the EU declaration of conformity, affix the CE marking and add the number of the notified body concerned with the approval of the production phase provided he is fully responsible for and in control of the production.

In this case, he is the "de facto" manufacturer of the product. He can show full responsibility by, for example, placing a sub-contract for production with the actual manufacturer. The "de facto" manufacturer, in this case, is also responsible for engaging a notified body to approve and carry out periodic surveillance of the quality management system used in production, whether in the EU or elsewhere in the world.

The number to be applied after the CE marking is that of the notified body appointed by the "de facto" manufacturer to assess the quality management system.

Case 3: Second EU-type examination certificate in a second manufacturer or trade agent's name

A manufacturer A, whose quality management system is approved according to Directive 2014/34/EU by a notified body NB1, produces and sells equipment for which he holds an EU-type examination certificate issued in his own name. A second manufacturer acting as a trade agent B, whose quality management system is approved according to Directive 2014/34/EU by another notified body NB2, applies for an EU-type examination certificate in his name, B, based on the certificate previously granted to original manufacturer A by a notified body NB. On receipt of the certificate he then manufactures the product, issues his own EU declaration of conformity, affixes the CE-mark with the identification number of the notified body NB2 and sells the equipment in his own name on the EU market.

Alternatively, manufacturer B may choose to have the equipment manufactured under subcontract. In this case he must ensure that the quality system used by the sub-contractor is in compliance with the relevant requirements of Directive 2014/34/EU. If the quality system is again approved by notified body NB2, the manufacturer B can issue his own EU declaration of conformity, affix the CE-mark together with the identification number of the notified body NB2 and sell the product in his own name on the EU market.

Although the procedure for issuing a second EU-type examination certificate in a second manufacturer's name is not explicitly covered by Directive 2014/34/EU, it

would appear justifiable in order to support established commercial practices, e.g. manufacturing or selling under licence.

In applying for the second certificate, in order to get the required product certification for the EU market place, manufacturer or trade agent B has to submit to the appropriate notified body:

- the original or a copy of the EU-type examination certificate issue by notified body NB in A's name,
- a declaration by the original manufacturer A that the equipment to be produced under the name of the second manufacturer or trade agent B will be identical with the originally certified equipment,
- a declaration by the second manufacturer or trade agent B that the equipment brought to the EU market will be identical to that originally certified, and
- the original or a copy of the contractual agreement between A and B.

NB, as the notified body assessing manufacturer A's product, will issue a new EU-type examination certificate and report based upon the EU-type examination certificate and report issued in manufacturer A's name.

This is necessary to follow the line of quality management back to the original EU-type examination assessment, to ensure the traceability of Quality Assurance. In fact, manufacturer or trade agent B needs to get the required Quality Assurance Notification (QAN) for the EU market place: notified body NB2 assessing B's quality assurance system will issue a Quality Assurance Notification to B once they have assured that the requirements of the appropriate Directive Annex has been satisfied. Since B does not physically produce the ATEX product himself, a full assessment against Annex IV or VII cannot be achieved unless the compliance of manufacturer A's quality assurance system, as the actual producer of B's product, has been established to ensure the following:

- the line of quality assurance can be followed back to the original EU-type examination assessment issued by notified body NB1 and held by manufacturer A;
- compliance with the requirements of Annex IV or VII have been demonstrated through the combined quality assurance systems of trade agent B (covered by the QAN issued by notified body NB2) and the actual producer, manufacturer A (covered by the QAN issued by notified body NB1);
- an appropriate quality assurance system exists for the products identified in EU-type examination certificate, so that notified body NB2 can issue its own QAN to trade agent B and permit the use of its NB2 number adjacent to the CE-mark on the label of the B's product.

See the diagram in the next page:

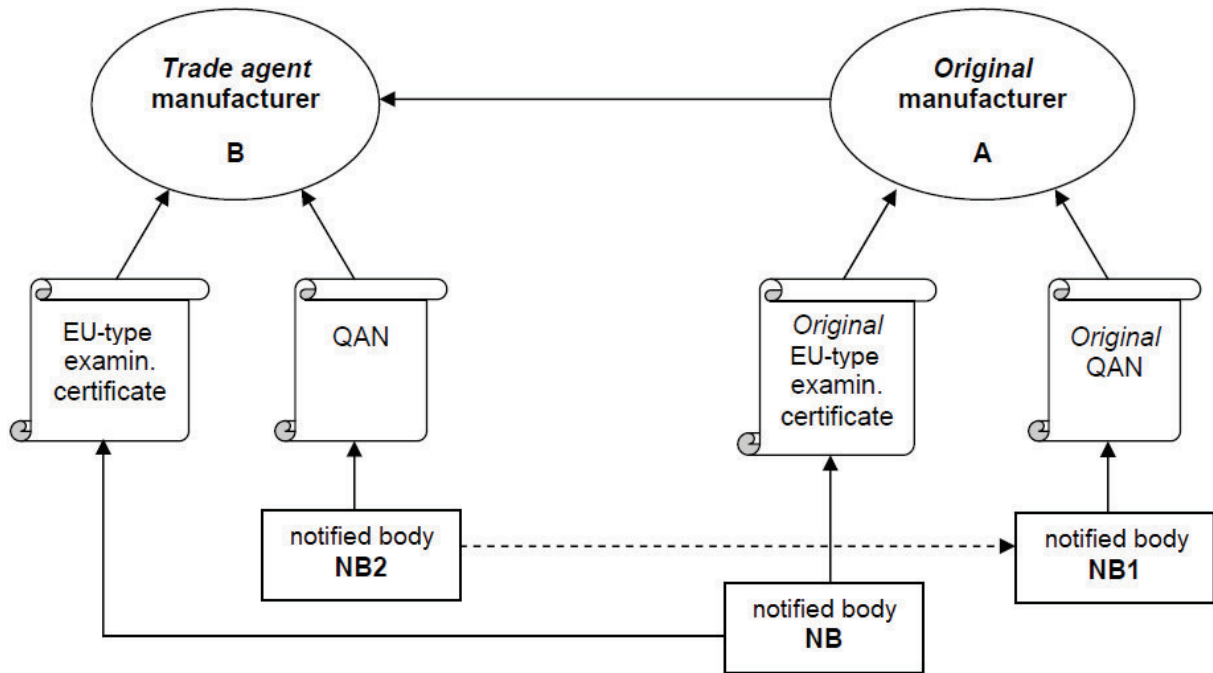

So, trade agent B has been granted an EU-type examination certificate, issued by notified body NB, based upon the EU-type examination certificate issued in manufacturer A's name, and holds a Quality Assurance Notification in his own name, issued by notified body NB2, that allows that the ATEX product placed onto the market in B's name to bear NB2 number. NB2 must inform NB1 accordingly.

The EU market is presented with a new ATEX product that appears to be made by B and satisfies the requirements of the ATEX Directive; but the market place, in principle, has no knowledge of the relationship between companies B and A, and, under the ATEX Directive, B is considered the "manufacturer" and has fulfilled all the necessary requirements for a manufacturer.

In order to ensure that the requirements of the directive are effectively fulfilled, it is necessary to keep visible traceability of the QAN held by trade agent B to the QAN issued to manufacturer A, in particular to guarantee:

- that the original EU-type examination certificate held by A and used as the basis for the EU-type examination certificate issued to B is included in an existing QAN;
- that the version labelled for B will be examined by the original product manufacturer's notified body NB1, during the course of their surveillance assessment as they may be unaware of the existence of B's activities which have been conducted through a different notified body NB2.

Otherwise, there is a significant danger that the product described on the EU-type examination certificate issued to trade agent B by notified body NB is never subjected to a quality assurance system assessment at the actual place of production by NB1 as the notified body of the original manufacturer, A, fundamentally undermining the principles of the ATEX Directive.

As a solution, when trade agent B is provided with an EU-type examination certificate, B's QAN and A's QAN as the actual manufacturer with whom B has a

contractual agreement, are to be updated to identify the products covered by B's EU-type examination certificate within the schedules. This ensure that the quality assurance system at trade agent B's location and manufacturer A's, the actual product producer, are examined by their relevant notified bodies NB1 and NB2.

In addition, in the event of trade agent B identifying, or being advised of, an issue related to the safety of its ATEX product, there is a mean by which the quality assurance of the product can be easily traced back to the original producer, manufacturer A, irrespective of how many notified bodies are involved, and all other trade agents of the same type of product can then be easily advised of the issues.

§ 78 Manufacturing of ATEX products for own use

Whoever puts into service products covered by the Directive, which he has manufactured for his own use, is considered to be a manufacturer. He is obliged to conform to the Directive in relation to the obligations of the manufacturer. This is true for new products manufactured for own use as well as for used products (*see section § 33*) which have been substantially modified.

§ 79 The official languages of the European Union

The determination by the Member State concerned of the "language which can be easily understood by end-users", as indicated in Article 6(8) for instructions and safety information, is related to the official languages used in the 28 EU Member States. At present, there are 24 official EU languages:

Austria	– German	Italy	– Italian
Belgium	– Dutch, French and German	Latvia	– Latvian
Bulgaria	– Bulgarian	Lithuania	– Lithuanian
Croatia	– Croatian	Luxembourg	– French and German
Cyprus	– Greek	Malta	– Maltese and English
Czech Republic	– Czech	Netherlands	– Dutch
Denmark	– Danish	Poland	– Polish
Estonia	– Estonian	Portugal	– Portuguese
Finland	– Finnish and Swedish	Romania	– Romanian
France	– French	Slovakia	– Slovak
Germany	– German	Slovenia	– Slovenian
Greece	– Greek	Spain	– Spanish (Castilian)
Hungary	– Hungarian	Sweden	– Swedish
Ireland	– Irish (Gaelic) and English	United Kingdom	– English

Certain of the Member States with two or more official languages (Belgium, Finland) accept the use of one language only in areas where only that language is spoken; other Member States with two official languages (Malta and Ireland) accept the sole use of English. Manufacturers are advised to check this with the national authorities concerned.

In the other countries where the ATEX Directive applies in virtue of the European Economic Area (EEA), the Mutual Recognition Agreement (MRA) with Switzerland and the Custom Union (CU) with Turkey, the national provisions implementing the Directive require the use of the official language(s) of the country concerned:

Iceland – Icelandic
Liechtenstein – German
Norway – Norwegian

Switzerland – French, German and Italian
Turkey – Turkish

Article 7
Authorised representatives

1. A manufacturer may, by a written mandate, appoint an authorised representative.

The obligations laid down in Article 6(1) and the obligation to draw up technical documentation referred to in Article 6(2) shall not form part of the authorised representative's mandate.

2. An authorised representative shall perform the tasks specified in the mandate received from the manufacturer. The mandate shall allow the authorised representative to do at least the following:

- (a) keep the EU declaration of conformity or, where applicable, the attestation of conformity and the technical documentation at the disposal of national market surveillance authorities for 10 years after the product has been placed on the market;
- (b) further to a reasoned request from a competent national authority, provide that authority with all the information and documentation necessary to demonstrate the conformity of a product;
- (c) cooperate with the competent national authorities, at their request, on any action taken to eliminate the risks posed by products covered by the authorised representative's mandate.

§ 80 Authorised representatives

For the definition of authorised representative, see section [§ 56](#).

Article 7 of the ATEX Directive 2014/34/EU, as well as the specific provisions in Annexes III to IX, defines the obligations incumbent on the authorised representative established within the EU with regard to conformity assessment, CE markings, EU declaration of conformity and the arrangements for holding this EU declaration of conformity, together with the technical documentation, at the disposal of the competent authorities for a period of 10 (ten) years after the last product has been manufactured.

See also § 3.2. "Authorised representative" in "[The 'Blue Guide' on the implementation of EU product rules](#)".

Article 8
Obligations of importers

1. Importers shall place only compliant products on the market.

2. Before placing a product on the market importers shall ensure that the appropriate conformity assessment procedure referred to in Article 13 has been carried out by the manufacturer. They shall ensure that the manufacturer has drawn up the technical documentation, that the product bears the CE marking, where applicable, is accompanied by the EU declaration of conformity or the attestation of conformity and the required documents, and that the manufacturer has complied with the requirements set out in Article 6(5), (6) and (7).

Where an importer considers or has reason to believe that a product is not in conformity with the essential health and safety requirements set out in Annex II, he shall not place the product on the market until it has been brought into conformity. Furthermore, where the product presents a risk, the importer shall inform the manufacturer and the market surveillance authorities to that effect.

3. Importers shall indicate on the product their name, registered trade name or registered trade mark and the postal address at which they can be contacted or, where that is not possible, on its packaging or in a document accompanying the product. The contact details shall be in a language easily understood by end-users and market surveillance authorities.

4. Importers shall ensure that the product is accompanied by instructions and safety information in a language which can be easily understood by end-users, as determined by the Member State concerned.

5. Importers shall ensure that, while a product is under their responsibility, its storage or transport conditions do not jeopardise its compliance with the essential health and safety requirements set out in Annex II.

6. When deemed appropriate with regard to the risks presented by a product, importers shall, to protect the health and safety of end-users, carry out sample testing of products made available on the market, investigate, and, if necessary, keep a register of complaints, of non-conforming products and product recalls, and shall keep distributors informed of any such monitoring.

7. Importers who consider or have reason to believe that a product which they have placed on the market is not in conformity with this Directive shall immediately take the corrective measures necessary to bring that product into conformity, to withdraw it or recall it, if appropriate. Furthermore, where the product presents a risk, importers shall immediately inform the competent national authorities of the Member States in which they made the product available on the market to that effect, giving details, in particular, of the non-compliance and of any corrective measures taken.

8. Importers shall, for 10 years after the product has been placed on the market, keep a copy of the EU declaration of conformity or, where applicable, of the attestation of conformity at the disposal of the market surveillance authorities and ensure that the technical documentation can be made available to those authorities, upon request.

9. Importers shall, further to a reasoned request from a competent national authority, provide it with all the information and documentation in paper or electronic form necessary to demonstrate the conformity of a product in a language which can be easily understood by that

authority. They shall cooperate with that authority, at its request, on any action taken to eliminate the risks posed by products which they have placed on the market.

§ 81 Obligations of importers

For the definition of importer, see section [§ 57](#).

The importer has important and clearly defined responsibilities under the Directive; to a large extent they build on the type of responsibilities which a manufacturer based in the EU is subjected to.

The importer must ensure that the manufacturer has correctly fulfilled his obligations. The importer is not a simple re-seller of products, but has a key role to play in guaranteeing the compliance of imported products.

See also § 3.3. "Importer" in "[The 'Blue Guide' on the implementation of EU product rules](#)".

Article 9 **Obligations of distributors**

1. When making a product available on the market distributors shall act with due care in relation to the requirements of this Directive.

2. Before making a product available on the market distributors shall verify that the product bears the CE marking, where applicable, that it is accompanied by the EU declaration of conformity or the attestation of conformity and the required documents and by instructions and safety information, in a language which can be easily understood by end-users in the Member State in which the product is to be made available on the market, and that the manufacturer and the importer have complied with the requirements set out in Article 6(5), (6) and (7) and Article 8(3) respectively.

Where a distributor considers or has reason to believe that a product is not in conformity with the essential health and safety requirements set out in Annex II, he shall not make the product available on the market until it has been brought into conformity. Furthermore, where the product presents a risk, the distributor shall inform the manufacturer or the importer to that effect as well as the market surveillance authorities.

3. Distributors shall ensure that, while a product is under their responsibility, its storage or transport conditions do not jeopardise its compliance with the essential health and safety requirements set out in Annex II.

4. Distributors who consider or have reason to believe that a product which they have made available on the market is not in conformity with this Directive shall make sure that the corrective measures necessary to bring that product into conformity, to withdraw it or recall it, if appropriate, are taken. Furthermore, where the product presents a risk, distributors shall immediately inform the competent national authorities of the Member States in which they made the product available on the market to that effect, giving details, in particular, of the non-compliance and of any corrective measures taken.

5. Distributors shall, further to a reasoned request from a competent national authority, provide it with all the information and documentation in paper or electronic form necessary to demonstrate the conformity of a product. They shall cooperate with that authority, at its request, on any action taken to eliminate the risks posed by products which they have made available on the market.

§ 82 Obligations of distributors

For the definition of distributor, see section [§ 58](#).

Along with manufacturers and importers, distributors are the third category of economic operators who are subject to specific obligations. Retailers, wholesalers and other distributors in the supply chain are not required to have a preferential relationship with the manufacturer like the authorised representative. A distributor acquires products for further distribution either from a manufacturer, from an importer, or from another distributor.

Distributor must act with due care in relation to the applicable requirements. They have to know, for instance, which products must bear the CE marking, what information is to accompany the product (for example the EU declaration of conformity), what are the language requirements for labelling, user instructions or other accompanying documents, and what is a clear indication of the product being non-compliant. Distributors have an obligation to demonstrate to the national market surveillance authority that they have acted with due care and ensure that the manufacturer, or his authorised representative, or the person who provided him with the product has taken the measures required by the Directive as listed in the obligations for distributors.

Conformity assessment, drawing up and keeping the EU declaration of conformity and the technical documentation remain the responsibility of the manufacturer and/or importer in the case of products from third countries. It is not part of the distributor's obligations to check whether a product already placed on the market is still in conformity with the legal obligations that are currently applicable in case these have changed. The obligations of the distributor refer to the legislation applicable when the product was placed on the market by the manufacturer or the importer unless specific legislation provides otherwise.

The distributor must be able to identify the manufacturer, his authorised representative, the importer or the person who has provided him with the product in order to assist the market surveillance authority in its efforts to obtain the EU declaration of conformity and the necessary parts of the technical documentation. Market surveillance authorities have the possibility to address their request for the technical documentation directly to the distributor. The latter is however not expected to be in possession of the relevant documentation.

See also § 3.4. "Distributor" in "[The 'Blue Guide' on the implementation of EU product rules](#)".

Article 10

Cases in which obligations of manufacturers apply to importers and distributors

An importer or distributor shall be considered a manufacturer for the purposes of this Directive and he shall be subject to the obligations of the manufacturer under Article 6, where he places a product on the market under his name or trade mark or modifies a product already placed on the market in such a way that compliance with this Directive may be affected.

§ 83 Obligations of manufacturers for importers and distributors

If the product is marketed under another person's name or trademark, this person will be considered as the manufacturer.

The responsibilities of the manufacturer apply also to any natural or legal person who assembles, packs, processes or labels ready-made products and places them on the market under his own name or trademark. Further, the responsibility of the manufacturer is placed on any person who changes the intended use of a product in such a way that different essential or other legal requirements will become applicable, or substantially modifies or re-builds a product (thus creating a new product), with a view to placing it on the market.

See also § 3.1. "Manufacturer" in ["The 'Blue Guide' on the implementation of EU product rules"](#).

Article 11

Identification of economic operators

Economic operators shall, on request, identify the following to the market surveillance authorities:

- (a) any economic operator who has supplied them with a product;
- (b) any economic operator to whom they have supplied a product.

Economic operators shall be able to present the information referred to in the first paragraph for 10 years after they have been supplied with the product and for 10 years after they have supplied the product.

§ 84 Identification of economic operators

Economic operators are obliged to keep track of the economic operators they supplied their product to or from whom they bought products for a period of 10 (ten) years. End-users are not covered by this requirement as they are not considered to be economic operators.

The way to comply with this requirement by economic operators is not prescribed by the Directive, but it must be noted that market surveillance authorities can ask for relevant documents, including invoices, allowing the origin of the product to be

traced. Hence, it could be useful to keep invoices for a longer period than envisaged in accounting legislation to comply with the requirements on traceability.

See also § 4.2.2.4. "*Identification of economic operators*" in "[The 'Blue Guide' on the implementation of EU product rules](#)".

CHAPTER 3 CONFORMITY OF THE PRODUCT

§ 85 *Conformity of the product*

Chapter 3 of the ATEX Directive 2014/34/EU deals with presumption of conformity of products, conformity assessment procedures and the EU declaration of conformity.

Article 12 Presumption of conformity of products

1. Products which are in conformity with harmonised standards or parts thereof the references of which have been published in the *Official Journal of the European Union* shall be presumed to be in conformity with the essential health and safety requirements set out in Annex II covered by those standards or parts thereof.
2. In the absence of harmonised standards, Member States shall take any steps which they deem necessary to bring to the attention of the parties concerned the existing national standards and technical specifications regarded as important or relevant to the proper implementation of the essential health and safety requirements set out in Annex II.

§ 86 *Presumption of conformity of products*

The presumption of conformity of products is conferred by the use of European harmonised standards the reference of which is published in the Official Journal of the European Union (OJEU).

The European Standardisation Organisations (CEN, CENELEC and ETSI) and their specific Technical Committees, as well as other sectoral interested parties (national experts, notified bodies, industry, etc.) are involved in the development of European standards. These standards are commonly the preferred option for demonstrating compliance once they become available as harmonised standards.

Voluntary harmonised standards are the only documents the application of which provides for presumption of conformity in the sense of the Directive. Manufacturers may also decide to use other existing European, international or national standards and/or technical specifications regarded as important, relevant or useful to cover the applicable essential health and safety requirements of the Directive, together with additional controls addressing those other requirements not already covered.

European standards are amended and updated in a regular basis and in response to new technical knowledge, to reflect the available "state of the art". During the process

of updating, a manufacturer may continue to use a current harmonised standard to claim full compliance with the Directive, until a new harmonised standard replaces (supersedes) the previous one, at the end of the established transition period, as usually set.

§ 87 European harmonised standards in the Official Journal

The consolidated lists of references of European harmonised standards under the ATEX Directive 2014/34/EU, published on the Official Journal of the European Union (OJEU), can be found on "EUR-Lex" <http://eur-lex.europa.eu/oj/direct-access.html> and on the Commission's website <http://ec.europa.eu/growth/single-market/european-standards/harmonised-standards/equipment-explosive-atmosphere/>.

European standards for ATEX are produced by and available from two European Standardisation Organisations:

- European Committee for Standardization (CEN): avenue Marnix 17, 1000 Brussels, Belgium; tel. (32-2) 550 08 11; fax (32-2) 550 08 19; website <http://www.cen.eu>;
- European Committee for Electrotechnical Standardization (CENELEC): avenue Marnix 17, 1000 Brussels, Belgium; tel. (32-2) 519 68 71; fax (32-2) 519 69 19; website <http://www.cenelec.eu>.

National transpositions of European harmonised standards are available from the national standardisation bodies, members of CEN and CENELEC.

§ 88 Standardisation programme

There are two standardisation programmes addressed to the European Standardisation Organisations active in the ATEX sector: CEN and CENELEC. Each one is the subject of a standardisation mandate drawn up by the European Commission.

The European Commission has granted a mandate to CEN and CENELEC to produce European standards to be harmonised. The mandate covers the standardisation work necessary for the optimum functioning of the Directive in both the electrical and non-electrical field.

The mandate requires intensive co-operation between CEN and CENELEC to carry out the following work:

- to review and, where appropriate, modify existing standards with a view to aligning them with the essential health and safety requirements of the Directive;
- to establish the new standards required, giving priority to horizontal standards, which apply to broad ranges of products, rather than to specific products, with the need for them to be demonstrated on a case-by-case basis.

To carry out their mandate in the ATEX field, CEN and CENELEC has established two specific Technical Committees (TCs):

- CEN/TC 305 "Potentially explosive atmospheres - Explosion prevention and protection"
- and

- CLC/TC 31 "Electrical apparatus for potentially explosive atmospheres".

Several working groups and sub-committees carry out the detailed work within each of these Technical Committees. These Committees have been working in the potentially explosive atmosphere field for a considerable number of years.

CEN and CENELEC are responsible for the preparation of standards of the electrical and non-electrical sectors of industry respectively. They have the responsibility to ensure that:

- they have a common understanding on the requirements of the ATEX Directive 2014/34/EU, and other relevant directives and regulations when applicable;
- safety requirements for the electrical and non-electrical sectors are compatible where they overlap, and the levels of safety sought are equivalent;
- the preparation of standards in the future by one of the organisations satisfactorily reflects the needs of the other, and vice versa.

Article 13

Conformity assessment procedures

1. The procedures to be followed for assessing the conformity of equipment and, where necessary, the devices referred to in point (b) of Article 1(1) shall be as follows:

(a) for equipment-group I and II, equipment-category M 1 and 1, the EU-type examination set out in Annex III, in conjunction with either of the following:

- conformity to type based on quality assurance of the production process set out in Annex IV;
- conformity to type based on product verification set out in Annex V;

(b) for equipment-group I and II, equipment-category M 2 and 2:

(i) in the case of internal combustion engines and electrical equipment in these groups and categories, the EU-type examination set out in Annex III, in conjunction with either of the following:

- conformity to type based on internal production control plus supervised product testing set out in Annex VI;
- conformity to type based on product quality assurance set out in Annex VII;

(ii) in the case of other equipment in these groups and categories, internal production control set out in Annex VIII and the communication of the technical documentation provided for in Annex VIII, point 2, to a notified body, which shall acknowledge receipt of it as soon as possible and shall retain it;

(c) for equipment-group II, equipment-category 3, internal production control set out in Annex VIII;

(d) for equipment-groups I and II, in addition to the procedures referred to in points (a), (b) and (c) of this paragraph, conformity based on unit verification set out in Annex IX may also be followed.

2. The procedure referred to in points (a) or (d) of paragraph 1 shall be used for conformity assessment of protective systems.

3. The procedures referred to in paragraph 1 shall be applied in respect of components with the exception of the affixing of the CE marking and the drawing up of the EU declaration of conformity. A written attestation of conformity shall be issued by the manufacturer, declaring the conformity of the components with the applicable provisions of this Directive and stating their characteristics and how they must be incorporated into equipment or protective systems to assist compliance with the essential health and safety requirements set out in Annex II applicable to finished equipment or protective systems.

4. With regard to the safety aspects referred to in point 1.2.7 of Annex II, in addition to the conformity assessment procedures referred to in paragraphs 1 and 2, the procedure referred to in Annex VIII may also be followed.

5. By derogation from paragraphs 1, 2 and 4, the competent authorities may, on a duly justified request, authorise the placing on the market and putting into service on the territory of the Member State concerned of the products other than components in respect of which the procedures referred to in paragraphs 1, 2 and 4 have not been applied and the use of which is in the interests of protection.

6. Documents and correspondence relating to the conformity assessment procedures referred to in paragraphs 1 to 4 shall be drawn up in a language, determined by the Member State concerned.

§ 89 Conformity assessment procedures

Article 13 of the Directive describes the conformity assessment procedures whereby the manufacturer or his authorised representative established within the EU ensures and declares that the product complied with the ATEX Directive 2014/34/EU and its relevant essential health and safety requirements. References are made to the procedures as described in Annexes III to IX, from the Modules A to G included in Annex II to the [Decision No 768/2008/EC](#) within the [New Legislative Framework](#) (see [section § 5](#)).

Article 13(1)(a) describes the procedures in the case of equipment; autonomous protective systems; for safety devices for such equipment or systems; and for components for such equipment, systems or devices, under equipment-groups I and II, equipment categories M 1 and 1. The options are either:

- i) EU-type examination³¹ (*Module B*) followed by:
 - Conformity to type based on quality assurance of the production process³² (*Module D*), or,

³¹ See Annex III to the Directive.

³² See Annex IV to the Directive.

- Conformity to type based on product verification³³ (*Module F*);
- ii) Conformity based on unit verification³⁴(*Module G*).

Article 13(1)(b) describes the procedure in the case of equipment; for safety devices for such equipment; and for components of such equipment or devices, under equipment-groups I and II, equipment categories M 2 and 2. The options are either:

For internal combustion engines and electrical equipment:

- i) EU-type examination⁸ (*Module B*) followed by:
 - Conformity to type based on internal production control plus supervised product testing³⁵ (*Module C1*), or,
 - Conformity to type based on product quality assurance³⁶ (*Module E*).
- ii) Conformity based on unit verification¹¹ (*Module G*).

For other equipment:

- i) Internal production control³⁷ (*Module A*) and the communication/deposit of the technical documentation³⁸ to a notified body³⁹, or,
- ii) Conformity based on unit verification¹¹ (*Module G*).

Article 13(1)(c) describes the procedure in the case of equipment; for safety devices for such equipment; and for components for such equipment and devices under equipment-group II, equipment category 3. The options are either:

- i) Internal production control¹⁴ (*Module A*), or,
- ii) Conformity based on unit verification¹¹ (*Module G*).

On the other hand, safety, controlling and regulating devices have to comply with the requirements of Annex II, clause 1, especially clause 1.5.

The formal conformity assessment procedures of Article 8 apply and the safety devices are assessed according to the equipment group and category of the system consisting of the safety device and the equipment under control. In some cases it is necessary to perform the assessment for the combination (e.g. inverter fed motors), but generally the assessment for a group of equipment and the appropriate safety devices can be done separately (e.g. type 'e' motor).

³³ See Annex V to the Directive.

³⁴ See Annex IX to the Directive.

³⁵ See Annex VI to the Directive.

³⁶ See Annex VII to the Directive.

³⁷ See Annex VIII to the Directive.

³⁸ See paragraph 2 of Annex VIII.

³⁹ Conditions of communication and of retention/storage of documents shall be agreed between the notified body and its client.

Example: a type 'e' motor of category 2 is controlled by an overload protection device located outside the explosive atmosphere. The conformity assessment procedure of equipment group II and category 2 is applied for the safety device.

In brief, the different conformity assessment procedures, as appropriate for each kind of ATEX products, are listed in the following **Table 3: Conformity assessment procedures for the ATEX Directive 2014/34/EU** and showed in the chart provided overleaf.

Table 3: Conformity assessment procedures for the ATEX Directive 2014/34/EU

Conformity assessment procedure	Directive 2014/34/EU	Short description
EU-type examination (Module B)	<i>Annex III</i>	Provides a specimen of the envisaged production to a notified body which undertakes the necessary evaluation to determine that the "type" meets the essential requirements of Directive 2014/34/EU and issues an EU-type examination certificate.
Conformity to type based on quality assurance of the production process (Module D)	<i>Annex IV</i>	Operates a quality system approved by a notified body for production, final equipment inspection and testing, subject to on-going surveillance.
Conformity to type based on product verification (Module F)	<i>Annex V</i>	Examination and tests by a notified body of every product to check the conformity of the equipment, protective system or device with the requirements of Directive 2014/34/EU and draw up a certificate of conformity.
Conformity to type based on internal production control plus supervised product testing (Module C1)	<i>Annex VI</i>	Tests carried out by a manufacturer on each piece of equipment manufactured to check the explosion protection aspects of the design. Carried out under the responsibility of a notified body.
Conformity to type based on product quality assurance (Module E)	<i>Annex VII</i>	A quality system approved by a notified body for the final inspection and testing of equipment, subject to on-going surveillance.
Internal production control (Module A)	<i>Annex VIII</i>	Product and quality system assessment procedure carried out by the manufacturer and retention of documentation.
Conformity based on unit verification (Module G)	<i>Annex IX</i>	A notified body examines individual equipment or protective system and carries out tests as defined in European harmonised standards, if they exist, or otherwise in European, international or national standards or conduct equivalent tests to ensure conformity with the relevant requirements of Directive 2014/34/EU and draw up a certificate of conformity.
Internal production control plus communication and retention of technical documentation by a notified body	<i>Article 13(1)(b)(ii)</i>	Product and quality system assessment procedure carried out by the manufacturer and retention of documentation by a notified body.

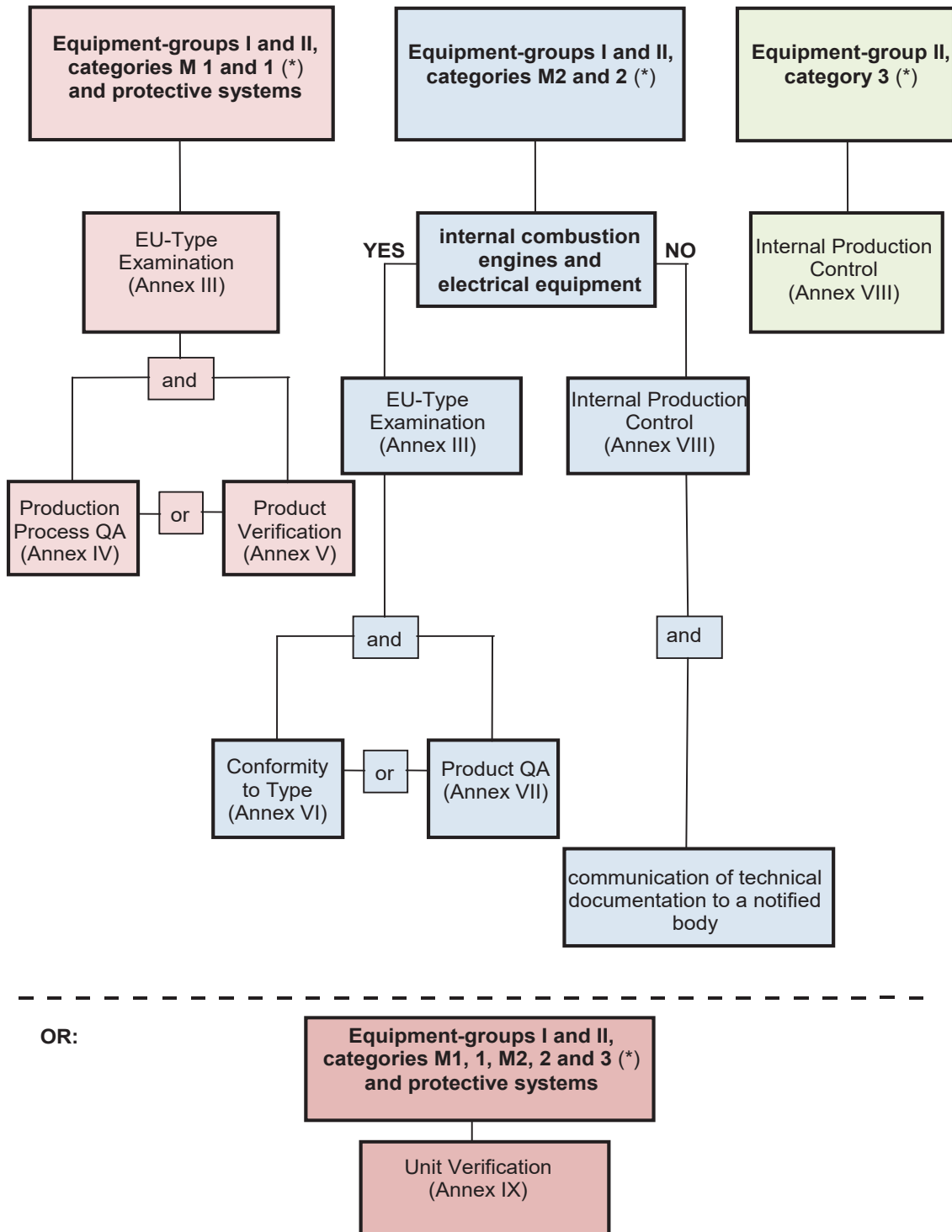

(*) and their components and devices according to Article 1(1), if separately assessed

Note: According to Article 13(4) for all equipment and protective systems of all groups and categories conformity to 1.2.7 of Annex II to the Directive 2014/34/EU (protection against other hazards) can be fulfilled by following the procedure of Internal Production Control (Annex VIII).

§ 90 Conformity assessment procedures in the case of different categories within one product

A question arises on which conformity assessment procedures have to be performed in the case of different categories within one product, or mixes of equipment and protective systems according to Article 1(1)(a).

If a product is made of parts which are assigned to different conformity assessment procedures it will be up to the manufacturer to decide how these parts and the whole product shall be placed on the market. The manufacturer can decide to realise the appropriate conformity assessment procedures for each part or for the whole product, even if he decides to place the product as an entirety on the market. In the case of separate conformity assessment procedures for each part of the combined/assembled equipment ("assembly") the manufacturer may presume conformity of these pieces of equipment and may restrict his own risk assessment of the assembly to those additional ignition and other hazards, which become relevant because of the final combination. If additional hazards are identified a further conformity assessment of the assembly regarding these additional risks is necessary.

If the manufacturer explicitly asks a notified body to assess the entire product, then that conformity assessment procedure, which covers the highest requirements, has to be applied. The notified body shall include into the EU-type examination (if relevant) all aspects of the product. Existing conformity declarations of the manufacturer for parts of the product should be given due consideration.

The notified body should inform the manufacturer about the possibilities of separate conformity assessment procedures for each part of the assembly.

Any certificate issued by the notified body should make clear which aspects of the product have been assessed by the notified body, and which have been assessed by the manufacturer alone.

Example: Vapour recovery pump for petrol stations

(a) The pump is sucking the petrol vapour-air mixture from the atmosphere and conveying it in pipe-work attributed to zone 0. Accordingly it is connected at its inlet and outlet to a potentially explosive atmosphere classified as zone 0. The pump itself is placed in a zone 1 environment.

With regard to the inlet and outlet connection the pump then has to comply with the requirements for category 1 equipment. The corresponding EU-type examination (equipment) has to be carried out by a notified body. With regard to the remaining (outer) body and integrated parts of the pump the notified body includes the necessary category 2 assessment into the certification, even if there are only non-electrical ignition sources to be considered.

Both categories shall be indicated in the EU-type examination certificate, making clear which aspects of the product have been assessed by the notified body, and which have been assessed by the manufacturer alone, and in the marking. For those category 2 parts of the pump, which show only non-electrical ignition sources and which are placed separately on the market, and for which the technical

documentation has been communicated to a notified body, an EU declaration of conformity (for equipment) or a written attestation of conformity (for components) of the manufacturer are sufficient.

(b) Often the pump is expected to prevent the passage of a deflagration flame from the inlet to the outlet connection, as typical vapour recovery pumps contain flame arresters in the inlet and outlet pipe. In this case the pump simultaneously may qualify as a protective system (in-line deflagration arrester).

A notified body – after having carried out a corresponding assessment of the flame arresting capability – may then issue a separate EU-type examination certificate for the pump as a protective system. In case that both aspects (equipment and protective system) have been assessed by the same notified body, only one EU-type examination certificate may be issued.

§ 91 Clarification for equipment with categories 2 or 3

See **Table 4: Clarification for equipment with categories 2 or 3** on the following page.

Table 4: Clarification for equipment with categories 2 or 3

Item	Marking	Product explanation	Comment	Equipment		EU-type examination certificate
				Electric	Non-electric	
1	II 1/2 G	Equipment installed with one part in zone 0 and one part in zone 1		X	X	Yes
2	II 2/3 G	Equipment installed with one part in zone 1 and one part in zone 2		X		Yes
3	II 2/3 G				X	
4	II 3 (2) G	Equipment installed in zone 2 and connected to an equipment placed in zone 1	An intrinsically safe barrier installed in zone 2	X		Yes
4 bis	II 3 (2) G	Ex power distribution installed in zone 2 and connected to an equipment placed in zone 1	Enclosure installed in zone 2 which contain a intrinsically safe barrier connected to a category 2 sensor	X		Yes (**)
7	II 2 G II 3 G	Equipment installed in zone 1 or in zone 2	Equipment with two versions based on the same housing	X		II 2 G ⇨ Yes II 3 G ⇨ No (*)
8	II 2 G II 3 D	Equipment installed in zone 1 or 22		X		II 2 G ⇨ Yes II 3 D ⇨ No (*)
9	II 2 G D II 3 G D	Equipment to be installed in zones 1 or 21 or 2 or 22	The same equipment with two different markings	X		II 2 G D ⇨ Yes II 3 G D ⇨ No (*)

(*) For those cases, only a type examination certificate can be issued by the certification body (but not as notified body)

(**) In case the safe barrier is not already placed on the market as II (2) G equipment, it is approvable for a manufacturer to apply for an EU type examination certificate for the Ex power distribution

§ 92 *Exceptional derogations of the conformity assessment procedures*

All products referred to in Article 1(1)(a) and (b) of the ATEX Directive 2014/34/EU are covered by the provisions of Article 13(5). This article gives the competent authority of the relevant Member State the possibility, in exceptional circumstances, to authorise the placing on the market and putting into service products (other than components) where the conformity assessment procedures have not been applied. This exception is possible:

- following a duly justified and successful request to the competent authority of the relevant Member State; and,
- if the use of the product is in the interests of protection of health and safety, and where, for example, such interests would be hindered by the delay associated with conformity assessment procedures; and,
- it is restricted to the territory of the Member State concerned.

This provision may be applied in safety relevant cases, in which the products in question are needed urgently and there is insufficient time to undergo the complete conformity assessment procedures (or to complete these procedures). The intention is to give Member States (in the interest of health and safety) the possibility to allow the placing on the market and putting into service innovative products without delay. But even in such cases the essential requirements of the Directive must be fulfilled.

With regard to the restrictive application conditions it has to be emphasised that the use of this clause has to remain exceptional and must not become a normal procedure. In the interests of transparency and to assist administrative co-operation (see also section [§ 116](#)), Member States are encouraged to provide the competent Commission services with details of any use of Article 13(5).

Article 14

EU declaration of conformity

1. The EU declaration of conformity shall state that the fulfilment of the essential health and safety requirements set out in Annex II has been demonstrated.
2. The EU declaration of conformity shall have the model structure set out in Annex X, shall contain the elements specified in the relevant conformity assessment procedures set out in Annexes III to IX and shall be continuously updated. It shall be translated into the language or languages required by the Member State in which the product is placed or made available on the market.
3. Where a product is subject to more than one Union act requiring an EU declaration of conformity, a single EU declaration of conformity shall be drawn up in respect of all such Union acts. That declaration shall contain the identification of the Union acts concerned, including their publication references.
4. By drawing up the EU declaration of conformity, the manufacturer shall assume responsibility for the compliance of the product with the requirements laid down in this Directive.

§ 93 *EU declaration of conformity*

The EU declaration of conformity is a legal statement by the manufacturer or his authorised representative established in the EU attesting that the concerned equipment or the protective system for potentially explosive atmospheres complies with all of the relevant provisions of the ATEX Directive 2014/34/EU.

Once the manufacturer has undertaken the appropriate procedures to assure conformity with the essential health and safety requirements of the Directive, it is the responsibility of the manufacturer or his authorised representative established in the EU to affix the CE marking and to draw up a written EU declaration of conformity.

The manufacturer or his authorised representative established in the EU keeps a copy of this EU declaration of conformity for a period of 10 (ten) years after the last equipment has been manufactured (see Articles 6 and 7). Where neither the manufacturer nor his authorised representative is established within the EU, the obligation to keep the copy of the EU declaration of conformity available, during the same period of 10 years, is the responsibility of the person who places the product on the EU market.

In respect of the notified bodies possibly involved in the conformity assessment procedure, the EU declaration of conformity must contain, where appropriate, the name and the identification number of the notified body, as well as the number of the EU-type examination certificate. The name and the identification number of a notified body involved in the production phase, where relevant, is not a mandatory requirement.

As far as assemblies of ATEX equipment are concerned, if an assembly is to be treated as a new item of ATEX equipment, the EU declaration of conformity needs only to identify the unit and the related information. Details of the items of equipment making up the assembly will be included on the technical file. However, there is a duty on all those in the supply chain to pass on the relevant information relating to the items of equipment where these have been previously placed on the market accompanied by their own EU declaration of conformity and instructions.

Annex X to the ATEX Directive 2014/34/EU states what the EU declaration of conformity must contain, as a minimum (see [section § 227](#)).

See also § 4.4. "EU Declaration of conformity" in "[The 'Blue Guide' on the implementation of EU product rules](#)".

§ 94 Written attestation of conformity for components

The EU declaration of conformity must not be confused with the written attestation of conformity for components mentioned in Article 13(3) of the ATEX Directive 2014/34/EU. In addition to declaring the conformity of the components with the provisions of the Directive, the written attestation of conformity or the attestation of conformity by cross-media documentation e.g. QR-codes with reference to internet, electronic catalogues, web-link on the package unit or delivery papers, etc. (as indicated in [section § 46](#) on components) has to state the characteristics of the components and how the components are to be incorporated into equipment or protective systems to ensure that the finished equipment or protective system meets the applicable essential health and safety requirements of the Directive.

Article 15

General principles of the CE marking

The CE marking shall be subject to the general principles set out in Article 30 of Regulation (EC) No 765/2008.

Article 16

Rules and conditions for affixing the CE marking and other markings

1. The CE marking shall be affixed visibly, legibly and indelibly to the product or to its data plate. Where that is not possible or not warranted on account of the nature of the product, it shall be affixed to the packaging and to the accompanying documents.
2. The CE marking shall be affixed before the product is placed on the market.
3. The CE marking shall be followed by the identification number of the notified body, where that body is involved in the production control phase.

The identification number of the notified body shall be affixed by the body itself or, under its instructions, by the manufacturer or his authorised representative.

4. The CE marking and, where applicable, the identification number of the notified body shall be followed by the specific marking of explosion protection , the symbols of the equipment group and category and, where applicable, the other markings and information referred to in point 1.0.5 of Annex II.
5. The CE marking and the markings, symbols and information referred to in paragraph 4, and, where applicable, the identification number of the notified body, may be followed by any other mark indicating a special risk or use.

Products that are designed for a particular explosive atmosphere shall be marked accordingly.

6. Member States shall build upon existing mechanisms to ensure correct application of the regime governing the CE marking and shall take appropriate action in the event of improper use of that marking.

§ 95 The CE marking. Rules and conditions for affixing the CE marking and other markings

[Regulation \(EC\) No 765/2008](#) lays down the general principles governing the CE marking, while [Decision No 768/2008/EC](#) provides for the rules governing its affixing. The ATEX Directive 2014/34/EU, as the other sectoral Union harmonisation legislation providing for CE marking, is based on the abovementioned Regulation and Directive.

See also § 4.5. "Marking requirements" in "[The 'Blue Guide' on the implementation of EU product rules](#)".

See also sections [§§ 144-150](#) on marking.

CHAPTER 4 NOTIFICATION OF CONFORMITY ASSESSMENT BODIES

§ 96 Notification of conformity assessment bodies: notified bodies

Chapter 4 of the ATEX Directive 2014/34/EU deals with the requirements and notification procedures for notifying authorities in the EU Member States and for notified conformity assessment bodies – in short, "notified bodies". The Directive includes the related contents of the [Decision No 768/2008/EC](#).

Notified bodies must provide the professional and independent judgements, which consequently enable manufacturers or their authorised representatives to fulfil the procedures in order to presume conformity to the Directive. Their intervention is required:

- for issuing EU-type examination certificates, and for inspection, verification and testing of equipment, protective systems, devices and components before they can be placed on the market and/or put into service;
- for the assessment of manufacturer's quality assurance system in the production phase.

See also §§ 5.2. "Conformity assessment bodies" and 5.3 "Notification" in "[The 'Blue Guide' on the implementation of EU product rules](#)".

Article 17 **Notification**

Member States shall notify the Commission and the other Member States of bodies authorised to carry out third-party conformity assessment tasks under this Directive.

§ 97 Notification

The bodies responsible for undertaking the work referred to in Article 13 of the Directive 2014/34/EU must be notified by the Member State under whose jurisdiction they fall, on their own responsibility, to the European Commission and the other Member States of the EU. This notification also includes the relevant scope of competence for which that body has been assessed as technically competent to certify against the essential health and safety requirements as shown in the Directive. For the EU Member States, this responsibility of notification involves the obligation to ensure that the notified bodies permanently maintain the technical competence required by Directive 2014/34/EU and that they keep their notifying authorities informed on the performance of their tasks.

Therefore, an EU Member State, which does not have a technically competent body under its jurisdiction to notify, is not required to make such a notification. This means that an EU Member State which does not have such a body is not required to create one if it does not feel the need to do so. A manufacturer always has the choice of contacting any body with the appropriate scope of technical competence, which has been notified by a Member State.

On their own responsibility, Member States reserve the right not to notify a body and to remove an appointment. In the latter circumstance the relevant Member State shall inform the Commission and all other Member States.

Article 18

Notifying authorities

1. Member States shall designate a notifying authority that shall be responsible for setting up and carrying out the necessary procedures for the assessment and notification of conformity assessment bodies and the monitoring of notified bodies, including compliance with the provisions of Article 23.
2. Member States may decide that the assessment and monitoring referred to in paragraph 1 is to be carried out by a national accreditation body within the meaning of and in accordance with Regulation (EC) No 765/2008.
3. Where the notifying authority delegates or otherwise entrusts the assessment, notification or monitoring referred to in paragraph 1 to a body which is not a governmental entity, that body shall be a legal entity and shall comply *mutatis mutandis* with the requirements laid down in Article 19. In addition it shall have arrangements to cover liabilities arising out of its activities.
4. The notifying authority shall take full responsibility for the tasks performed by the body referred to in paragraph 3.

§ 98 Notifying authorities

A notifying authority is the governmental or public body that is tasked with designating and notifying conformity assessment bodies under the ATEX Directive 2014/34/EU. Most often it is the national administration responsible for the implementation and management of the Directive under which the body is notified. Each Member State must designate a notifying authority to be responsible for the assessment, notification and monitoring of conformity assessment bodies. The notifying authority assumes full responsibility for the competence of the bodies it notifies.

Article 19

Requirements relating to notifying authorities

1. A notifying authority shall be established in such a way that no conflict of interest with conformity assessment bodies occurs.
2. A notifying authority shall be organised and operated so as to safeguard the objectivity and impartiality of its activities.
3. A notifying authority shall be organised in such a way that each decision relating to notification of a conformity assessment body is taken by competent persons different from those who carried out the assessment.

4. A notifying authority shall not offer or provide any activities that conformity assessment bodies perform or consultancy services on a commercial or competitive basis.
5. A notifying authority shall safeguard the confidentiality of the information it obtains.
6. A notifying authority shall have a sufficient number of competent personnel at its disposal for the proper performance of its tasks.

§ 99 Requirements relating to notifying authorities

Each Member State must establish its notifying authorities in such a way that there is no conflict of interest with conformity assessment bodies. They must be organised and operated so as to safeguard the objectivity and impartiality of their activities. Each decision relating to notification of a conformity assessment body must be taken by competent persons different from those who carried out the assessment.

Further requirements on a notifying authority are that it must not offer or provide any activities that conformity assessment bodies perform, or consultancy services on a commercial or competitive basis. It must safeguard the confidentiality of the information it obtains, and it must have a sufficient number of competent personnel at its disposal for the proper performance of its tasks.

Article 20

Information obligation on notifying authorities

Member States shall inform the Commission of their procedures for the assessment and notification of conformity assessment bodies and the monitoring of notified bodies, and of any changes thereto.

The Commission shall make that information publicly available.

§ 100 Information obligation on notifying authorities

Member States must inform the Commission of their procedures for the assessment and notification of conformity assessment bodies and the monitoring of notified bodies. The Commission makes that information publicly available on its website.

Article 21

Requirements relating to notified bodies

1. For the purposes of notification, a conformity assessment body shall meet the requirements laid down in paragraphs 2 to 11.
2. A conformity assessment body shall be established under the national law of a Member State and have legal personality.
3. A conformity assessment body shall be a third-party body independent of the organisation or the product it assesses.

A body belonging to a business association or professional federation representing undertakings involved in the design, manufacturing, provision, assembly, use or maintenance of products which it assesses, may, on condition that its independence and the absence of any conflict of interest are demonstrated, be considered such a body.

4. A conformity assessment body, its top level management and the personnel responsible for carrying out the conformity assessment tasks shall not be the designer, manufacturer, supplier, installer, purchaser, owner, user or maintainer of the products which they assess, nor the representative of any of those parties. This shall not preclude the use of assessed products that are necessary for the operations of the conformity assessment body or the use of such products for personal purposes.

A conformity assessment body, its top level management and the personnel responsible for carrying out the conformity assessment tasks shall not be directly involved in the design, manufacture or construction, the marketing, installation, use or maintenance of those products, or represent the parties engaged in those activities. They shall not engage in any activity that may conflict with their independence of judgement or integrity in relation to conformity assessment activities for which they are notified. This shall in particular apply to consultancy services.

Conformity assessment bodies shall ensure that the activities of their subsidiaries or subcontractors do not affect the confidentiality, objectivity or impartiality of their conformity assessment activities.

5. Conformity assessment bodies and their personnel shall carry out the conformity assessment activities with the highest degree of professional integrity and the requisite technical competence in the specific field and shall be free from all pressures and inducements, particularly financial, which might influence their judgement or the results of their conformity assessment activities, especially as regards persons or groups of persons with an interest in the results of those activities.

6. A conformity assessment body shall be capable of carrying out all the conformity assessment tasks assigned to it by Annexes III to VII and Annex IX and in relation to which it has been notified, whether those tasks are carried out by the conformity assessment body itself or on its behalf and under its responsibility.

At all times and for each conformity assessment procedure and each kind or category of products in relation to which it has been notified, a conformity assessment body shall have at its disposal the necessary:

- (a) personnel with technical knowledge and sufficient and appropriate experience to perform the conformity assessment tasks;
- (b) descriptions of procedures in accordance with which conformity assessment is carried out, ensuring the transparency and the ability of reproduction of those procedures. It shall have appropriate policies and procedures in place that distinguish between tasks it carries out as a notified body and other activities;
- (c) procedures for the performance of activities which take due account of the size of an undertaking, the sector in which it operates, its structure, the degree of complexity of

the product technology in question and the mass or serial nature of the production process.

A conformity assessment body shall have the means necessary to perform the technical and administrative tasks connected with the conformity assessment activities in an appropriate manner and shall have access to all necessary equipment or facilities.

7. The personnel responsible for carrying out conformity assessment tasks shall have the following:

- (a) sound technical and vocational training covering all the conformity assessment activities in relation to which the conformity assessment body has been notified;
- (b) satisfactory knowledge of the requirements of the assessments they carry out and adequate authority to carry out those assessments;
- (c) appropriate knowledge and understanding of the essential health and safety requirements set out in Annex II, of the applicable harmonised standards, of the relevant provisions of Union harmonisation legislation and of national legislation;
- (d) the ability to draw up certificates, records and reports demonstrating that assessments have been carried out.

8. The impartiality of the conformity assessment bodies, their top level management, and of the personnel responsible for carrying out the conformity assessment tasks shall be guaranteed.

The remuneration of the top level management and personnel responsible for carrying out the conformity assessment tasks of a conformity assessment body shall not depend on the number of assessments carried out or on the results of those assessments.

9. Conformity assessment bodies shall take out liability insurance unless liability is assumed by the State in accordance with national law, or the Member State itself is directly responsible for the conformity assessment.

10. The personnel of a conformity assessment body shall observe professional secrecy with regard to all information obtained in carrying out their tasks under Annexes III to VII and Annex IX or any provision of national law giving effect to it, except in relation to the competent authorities of the Member State in which its activities are carried out. Proprietary rights shall be protected.

11. Conformity assessment bodies shall participate in, or ensure that their personnel responsible for carrying out the conformity assessment tasks are informed of, the relevant standardisation activities and the activities of the notified body coordination group established under the relevant Union harmonisation legislation and shall apply as general guidance the administrative decisions and documents produced as a result of the work of that group.

§ 101 Requirements relating to notified bodies

Article 21 of the ATEX Directive 2014/34/EU defines the criteria that notified bodies must fulfil. Bodies which are able to provide proof of their conformity with such criteria

by presenting to their notifying authorities a certificate of accreditation and evidence that all additional requirements have been met, or other means of documentary proof, are considered notifiable and in this respect they conform to Article 21 of the Directive.

Notified bodies are designated to assess conformity with the essential health and safety requirements of the Directive, and to ensure consistent technical application of these requirements according to the relevant procedures in the Directive. The notified bodies must have appropriate facilities and technical staff that enable them to carry out technical and administrative tasks related to conformity assessment. They must also apply appropriate procedures of quality control in relation to such services provided. Manufacturers are free to choose any notified body that has been designated to carry out the conformity assessment procedure in question according to the Directive.

A notified body wishing to offer services according to several conformity assessment procedures must fulfil the relevant requirements for the respective tasks, and this has to be assessed according to the requirements for each different procedure in question. However, a notified body does not need to be qualified to cover all products falling within the scope of the Directive, but may be notified for a defined range of products only.

Notified bodies must have appropriate structures and procedures to ensure that the conduct of conformity assessment and the issuing of certificates are subject to a review process. Relevant procedures must, in particular, cover obligations and responsibilities in relation to suspension and withdrawal of certificates, requests addressed to the manufacturer to take corrective measures, and reporting to the competent authority.

Article 22

Presumption of conformity of notified bodies

Where a conformity assessment body demonstrates its conformity with the criteria laid down in the relevant harmonised standards or parts thereof the references of which have been published in the *Official Journal of the European Union*, it shall be presumed to comply with the requirements set out in Article 21 in so far as the applicable harmonised standards cover those requirements.

§ 102 Presumption of conformity of notified bodies

Relevant European harmonised standards provide useful and appropriate mechanisms towards presumption of conformity of notified bodies to the criteria set out in Article 21 of the Directive. However, this does not rule out the possibility that bodies not conforming to the harmonised standards may be notified, on the grounds that compliance is obligatory only with respect to the criteria set out in Article 21 to the Directive. It should also be noted that, where applicable, additional requirements including those set out in relevant sectoral schemes, are essential to carry out a specific conformity assessment activity.

Article 23

Subsidiaries of and subcontracting by notified bodies

1. Where a notified body subcontracts specific tasks connected with conformity assessment or has recourse to a subsidiary, it shall ensure that the subcontractor or the subsidiary meets the requirements set out in Article 21 and shall inform the notifying authority accordingly.
2. Notified bodies shall take full responsibility for the tasks performed by subcontractors or subsidiaries wherever these are established.
3. Activities may be subcontracted or carried out by a subsidiary only with the agreement of the client.
4. Notified bodies shall keep at the disposal of the notifying authority the relevant documents concerning the assessment of the qualifications of the subcontractor or the subsidiary and the work carried out by them under Annexes III to VII and Annex IX.

§ 103 Subsidiaries of and subcontracting by notified bodies

In order to comply with the provisions of Article 23 of the ATEX Directive 2014/34/EU, notified bodies are to keep a register of any subcontracting or subsidiarity to allow effective monitoring by the responsible Member State in order to ensure activities are being conducted properly. The register is to be updated systematically. The register contains information about the name and location of the subcontractor or the subsidiary, the nature and scope of work undertaken, the results of regular evaluations of the subcontractor, or the subsidiary including evidence that details of tasks are monitored as well as evidence that the subcontractor or the subsidiary is competent and maintains competence for the tasks specified and evidence that a direct private law contract exists.

A notified body may engage experts in support of its assessment activities but the experts' activities are to be controlled as if the expert were directly employed by the notified body under the same contractual obligations and operate within the notified body's own quality system.

The European ATEX Notified Bodies Group (ExNBG) (see [section § 117](#)) has concurred that further (serial) sub-contracting by any sub-contractor is strictly prohibited.

Although assessment can be sub-contracted including assessment against the relevant essential health and safety requirements, the notified body remains entirely responsible for the whole operation and shall safeguard impartiality and operational integrity.

Procedures for reviewing and accepting the work of any subcontractor or subsidiary will ensure that the subcontractor or the subsidiary has not offered or provided consultancy or advice to the manufacturer, supplier, authorised representative or their commercial competitor with respect to the design, construction, marketing or maintenance of the products which are the subject of the subcontracted task.

Article 24

Application for notification

1. A conformity assessment body shall submit an application for notification to the notifying authority of the Member State in which it is established.
2. The application for notification shall be accompanied by a description of the conformity assessment activities, the conformity assessment module or modules and the product or products for which that body claims to be competent, as well as by an accreditation certificate, where one exists, issued by a national accreditation body attesting that the conformity assessment body fulfils the requirements laid down in Article 21.
3. Where the conformity assessment body concerned cannot provide an accreditation certificate, it shall provide the notifying authority with all the documentary evidence necessary for the verification, recognition and regular monitoring of its compliance with the requirements laid down in Article 21.

Article 25

Notification procedure

1. Notifying authorities may notify only conformity assessment bodies which have satisfied the requirements laid down in Article 21.
2. They shall notify the Commission and the other Member States using the electronic notification tool developed and managed by the Commission.
3. The notification shall include full details of the conformity assessment activities, the conformity assessment module or modules and the product or products concerned and the relevant attestation of competence.
4. Where a notification is not based on an accreditation certificate as referred to in Article 24(2), the notifying authority shall provide the Commission and the other Member States with documentary evidence which attests to the conformity assessment body's competence and the arrangements in place to ensure that that body will be monitored regularly and will continue to satisfy the requirements laid down in Article 21.
5. The body concerned may perform the activities of a notified body only where no objections are raised by the Commission or the other Member States within two weeks of a notification where an accreditation certificate is used or within two months of a notification where accreditation is not used.

Only such a body shall be considered a notified body for the purposes of this Directive.

6. The notifying authority shall notify the Commission and the other Member States of any subsequent relevant changes to the notification.

§ 104 Application for notification and notification procedure

The [New Legislative Framework](#) from [Decision No 768/2008/EC](#) established detailed requirements for notified bodies and national authorities concerning, on one hand, the application for notification and the notification procedure.

See also § 5.3. "Notification" in "[The 'Blue Guide' on the implementation of EU product rules](#)".

Article 26

Identification numbers and lists of notified bodies

1. The Commission shall assign an identification number to a notified body.

It shall assign a single such number even where the body is notified under several Union acts.

2. The Commission shall make publicly available the list of the bodies notified under this Directive, including the identification numbers that have been assigned to them and the activities for which they have been notified.

The Commission shall ensure that the list is kept up to date.

§ 105 Identification numbers and lists of notified bodies. The NANDO database

When a body is notified for the first time under Union harmonisation legislation, the European Commission assign to it an identification number, in the format "NB xxxx" (4-digits correlative number).

For information purposes, the lists of notified bodies are made publicly available by the Commission on a specific database on its EUROPA server, called NANDO ("New Approach Notified and Designated Organisations" information system), available on <http://ec.europa.eu/growth/tools-databases/nando/index.cfm>.

The lists are updated as and when the notifications are published, and the website is refreshed daily to keep it up-to-date.

See also § 5.3.3. "Publication by the Commission - the NANDO web site" in "[The 'Blue Guide' on the implementation of EU product rules](#)".

Article 27

Changes to notifications

1. Where a notifying authority has ascertained or has been informed that a notified body no longer meets the requirements laid down in Article 21, or that it is failing to fulfil its obligations, the notifying authority shall restrict, suspend or withdraw notification as appropriate, depending on the seriousness of the failure to meet those requirements or fulfil those obligations. It shall immediately inform the Commission and the other Member States accordingly.

2. In the event of restriction, suspension or withdrawal of notification, or where the notified body has ceased its activity, the notifying Member State shall take appropriate steps

to ensure that the files of that body are either processed by another notified body or kept available for the responsible notifying and market surveillance authorities at their request.

§ 106 Changes to notification

In case of changes to notifications, the relevant national authority must substantially follow the same procedure for notification with regard to information to the Commission and the other EU Member States, in order to keep duly updated the list of notified bodies.

See also § 5.3.4. "Monitoring of the competence of notified bodies - suspension - withdrawal - appeal" in "[The 'Blue Guide' on the implementation of EU product rules](#)".

Article 28

Challenge of the competence of notified bodies

1. The Commission shall investigate all cases where it doubts, or doubt is brought to its attention regarding, the competence of a notified body or the continued fulfilment by a notified body of the requirements and responsibilities to which it is subject.

2. The notifying Member State shall provide the Commission, on request, with all information relating to the basis for the notification or the maintenance of the competence of the notified body concerned.

3. The Commission shall ensure that all sensitive information obtained in the course of its investigations is treated confidentially.

4. Where the Commission ascertains that a notified body does not meet or no longer meets the requirements for its notification, it shall adopt an implementing act requesting the notifying Member State to take the necessary corrective measures, including withdrawal of notification if necessary.

That implementing act shall be adopted in accordance with the advisory procedure referred to in Article 39(2).

§ 107 Challenge of the competence of notified bodies

The [New Legislative Framework](#) as in [Decision No 768/2008/EC](#) establishes the possibility to raise objections concerning a notified body, its competence and its activities. In such cases, the Commission has to carry out an investigation and, when the results demonstrate that a notified body does not meet or no longer meets the requirements for its notification, the Commission will adopt an implementing act (as an "Implementing Commission Decision") requesting the notifying Member State to take the necessary corrective measures, including withdrawal of notification if necessary.

Article 29

Operational obligations of notified bodies

1. Notified bodies shall carry out conformity assessments in accordance with the conformity assessment procedures provided for in Annexes III to VII and Annex IX.

2. Conformity assessments shall be carried out in a proportionate manner, avoiding unnecessary burdens for economic operators. Conformity assessment bodies shall perform their activities taking due account of the size of an undertaking, the sector in which it operates, its structure, the degree of complexity of the product technology in question and the mass or serial nature of the production process.

In so doing they shall nevertheless respect the degree of rigour and the level of protection required for the compliance of the product with the requirements of this Directive.

3. Where a notified body finds that the essential health and safety requirements set out in Annex II or corresponding harmonised standards or other technical specifications have not been met by a manufacturer, it shall require that manufacturer to take appropriate corrective measures and shall not issue a certificate of conformity.

4. Where, in the course of the monitoring of conformity following the issue of a certificate, a notified body finds that a product no longer complies, it shall require the manufacturer to take appropriate corrective measures and shall suspend or withdraw the certificate if necessary.

5. Where corrective measures are not taken or do not have the required effect, the notified body shall restrict, suspend or withdraw any certificates, as appropriate.

§ 108 Operational obligations of notified bodies

The operational obligations of notified bodies when performing their activities are listed in detail in the [New Legislative Framework](#) as from [Decision No 768/2008/EC](#).

§ 109 Documents issued by the notified body

A body notified under Directive 2014/34/EU issues the following documents according to the provisions of the relevant conformity assessment procedures:

- EU-type examination certificate.
- Product and production quality assurance notification.
- Conformity to type notification.
- Product verification, certificate of conformity.
- Unit verification, certificate of conformity.

These documents need not accompany the product.

It is not possible to issue an EU-type examination certificate for products of category 2 non-electrical equipment and of category 3, as mentioned in Article 13(1)(b)(ii) and 13(1)(c). Further, it is also not permissible to list such products on an EU-type examination certificate issued for products of categories other than these. This is because an EU-type examination certificate is an attestation that the products listed

on it have undergone the necessary conformity assessment procedures that result in the issuing of an EU-type examination certificate; it is not necessary for such products to undergo such conformity assessment procedures.

Where a single item is covered by more than one category, it may be permissible to issue an EU-type examination certificate. Under such circumstances, these items need to comply with the highest applicable conformity assessment requirements. If this requirement results in an EU-type examination certificate being issued, these products are permitted to be listed on an EU-type examination certificate.

A typical example of this is found in the semiconductor fabrication industry where a high vacuum pump is used to extract hydrogen but cannot meet the physical clearances necessary to justify category 2. Category 3 is adequate for the process as the pump is normally filled with pure hydrogen at low pressure, so there is no ignition risk except during the very brief transitions between operation and non-operation.

In this case, it is only the electrical part that is truly subject to EU-type examination but it is already established that a mechanical part can be considered along with the electrical part if they are integral with each other, rather than a mere assembly.

In such cases, it is not unreasonable to mention such items in the same set of documentation i.e. the products have an EU-type examination certificate issued for them.

However, where the products are discrete items e.g. two different type categories of a hand-held radio, one of which is category 2 and the other category 3, a single EU-type examination certificate should never be issued; the category 3 products should be listed on a separate document that in no way implied it was an EU-type examination certificate. The same should be true for components of items.

However, the voluntary issue of a certificate for products that are not permitted to be listed on an EU-type examination certificate is possible. The certification body may not give an indication on the certificate that it is a notified body because it would not be acting in that capacity. Therefore, the number of the notified body must not be affixed. Further, it is not permissible to affix the CE marking to such certificates.

§ 110 Provision of evaluation and test results with EU-type examination certificates

Although being a separate document, the report describing how the equipment fulfils the essential health and safety requirements of the Directive is considered to be integral to the provision of a certificate. Evaluation and test results supporting the decision to issue an EU-type examination certificate should accompany the certificate from the notified body to the manufacturer.

§ 111 Acceptance of test results of manufacturers by a notified body

Test reports can be a part of the technical documentation the manufacturer has to present to the notified body and the latter may take them into consideration appropriately.

Concerning safety relevant aspects in connection with Annex III (EU-type examination) and Annexes V (Product verification) and IX (Unit verification) to Directive 2014/34/EU, a notified body's independent and transparent intervention vis-à-vis the client and all interested parties (e.g. Member States, European Commission, manufacturers, other notified bodies) is required legally. Therefore a notified body only may accept test reports of manufacturers under certain conditions. The requirements included in the standard EN ISO/IEC 17025 *General requirements for the competence of testing and calibration laboratories (ISO/IEC 17025)* shall be used as basis for acceptance of test results.

The notified body has to state the acceptance of test results in his test report. In any case the notified body remains fully responsible for accepted test results and for the EU-type examination certificate (Annex III) or the certificate of conformity (Annexes V and IX) based on them.

§ 112 Minimum content of a European standardised ATEX test and assessment report

The term "test report" is used in a twofold way. In fact certification in scope of the Directive 2014/34/EU is based on three levels of reports:

- test in a laboratory, for example the measurement of a temperature, called "test report";
- assessment to the requirements of harmonised standards, called "assessment report";
- assessment to the essential health and safety requirements of the Directive, called "assessment report", too.

Having the possibility for very different types of test reports to be issued, varying from very poor reports, hardly including any information, to test reports with detailed test and evaluation results, a standardised ATEX assessment report format enables and ensures the following goals:

- a) Recognizable as an ATEX assessment report.
- b) Specified minimum content.
- c) Meeting the requirements for test reports as laid down in EN ISO/IEC 17025 and other applicable standards.
- d) Easy to use/integrate with existing formats currently used by all ATEX notified bodies.
- e) An ATEX assessment report is only issued if all applicable requirements are met and if all tests have been conducted with positive results (but still allowing waiving tests provided that the reasoning is given in the test report).

a) Recognizable as ATEX assessment report

The ATEX assessment report should be easy to identify as such by manufacturers, Ex notified/certification bodies and any other party as a genuine ATEX assessment report. Another possibility is to just require the use of the wording "ATEX assessment report" (exact wording to be agreed upon) on the cover page of the report; without the need for a standardized template for the ATEX assessment report as has been done for Annex III certificates.

b) Specified minimum content

The report shall contain a minimum amount of information that enables manufacturers to easily obtain other local/regional approvals/certificates based on the information in the report and any associated test documentation. An assessment report issued by an ATEX notified body that supports the issue of an EU-type examination shall contain:

- General information about the product, type designation, applicant, manufacturer, types of protection, technical data.
- Technical evaluation of the construction of the equipment. For most types of protection this can be a checklist (Yes / No / Not applicable + remarks) combined with the test documentation that specifies the construction; for intrinsic safety however a descriptive format is usually the best (if not the only) useable format. A detailed assessment narrative that confirms compliance with the standards used to support compliance with the ATEX Directive. For all aspects not covered by harmonised standards or if no standards are used, then the assessment narrative shall confirm compliance with the Directive. Since explosion safety standards are concept standards occasionally some interpretation is involved: the report should make clear how the assessment has been carried out.
- Results of tests:
 - details of tests carried out, relevant information about the test conditions, method and results shall be provided as part of the test report;
 - details of tests that have been waived and the justification for waiving those tests (the standard EN 60079-0 calls for a justification for waiving tests) shall be part of the assessment report;
 - details of tests that have been accepted from other organisations, test laboratories, etc. and a justification for accepting those tests shall be part of the assessment report. If tests are being accepted from other sources, then this should be clear, because the body that produces that data should be scrutinised. It could easily be disguised that test data from unsuitable sources had been used.
- Routine tests, if any: applicable to the product and agreed upon between the manufacturer and the notified body (applicable standards are EN 80079-34 *Explosive atmospheres - Part 34: Application of quality systems for equipment manufacture (ISO/IEC 80079-34)*, too).

c) Requirements for reporting

An ATEX test report shall meet all requirements for the content of test reports as specified in EN ISO/IEC 17025 *General requirements for the competence of testing and calibration laboratories (ISO/IEC 17025)*. In practice, this should not be any problem for a notified body since all of them conduct and report testing according to EN ISO/IEC 17025.

An ATEX assessment report shall meet all requirements as specified in EN ISO/IEC 17065 *Conformity assessment - Requirements for bodies certifying products, processes and services (ISO/IEC 17065)*.

d) Easy to use and integrate by notified bodies

It should be easy to integrate the European standardized ATEX assessment report in the operational procedures and documents used by a notified body. This requires that the format itself should not be 100% specified in detail, but only to the extent that all parties involved – issuing and receiving notified bodies and manufacturers – know

what to find in the test report. So the focus is on the content of the report, not its layout, numbering, etc. This should make it easy to implement the ATEX assessment report in the existing way of working of all individual notified bodies. It should not cause a significant increase (if any) in the costs for the manufacturer to obtain an ATEX certificate.

e) Full report

To avoid any confusion about the expected content of an ATEX assessment report, such a report should only be issued when the product involved meets all applicable requirements and has passed all applicable tests with positive results. An ATEX Assessment Report shall not be issued in case of any negative results or in case that only a part of the applicable requirements (for example IP54 requirements) have been evaluated or tested. This does not preclude the issuance of an ATEX assessment report for an Ex component, certified under a "U" certificate.

If a report with negative results or not fully assessed applicable requirements is given to the manufacturer it must be unambiguous that this is not an ATEX assessment report.

§ 113 Retention of technical documentation

Under Article 13(1)(b)(ii) of the ATEX Directive 2014/34/EU the manufacturer is required to undertake the conformity procedure at Annex VIII and then to carry out the communication of the technical documentation provided for in Annex VIII, point 2, to a notified body, which shall acknowledge receipt of it as soon as possible and shall retain it.

Bodies notified for this procedure should be so according to Article 13(1)(b)(ii) and not to Annex VIII as this latter procedure does not involve a notified body.

The referred technical documentation is not returned to the manufacturer on request (but may be added to), and in general it is retained for a period of 10 (ten) years following the last placing of the product onto the market. The intention is that market surveillance authorities in the different Member States should be given access to this dossier, in cases where there is a need to investigate the design or manufacturing details of a particular product.

With respect to the media used, it is accepted that this technical documentation may be in electronic format so long as it is legible and "readable" over the period concerned.

Article 30

Appeal against decisions of notified bodies

Member States shall ensure that an appeal procedure against decisions of the notified bodies is available.

§ 114 Appeal against decisions of notified bodies

Decisions taken by notified bodies – in particular concerning issuing or refusing of certificates – must be appealable by manufacturers or any other interested party, through appropriate legal procedures set out by the Member States. This should take into consideration the specific private/civil legal framework in which contractual agreements are stipulated between notified bodies and their customers (manufacturers or their authorised representatives).

Article 31

Information obligation on notified bodies

1. Notified bodies shall inform the notifying authority of the following:
 - (a) any refusal, restriction, suspension or withdrawal of a certificate;
 - (b) any circumstances affecting the scope of or conditions for notification;
 - (c) any request for information which they have received from market surveillance authorities regarding conformity assessment activities;
 - (d) on request, conformity assessment activities performed within the scope of their notification and any other activity performed, including cross-border activities and subcontracting.
2. Notified bodies shall provide the other bodies notified under this Directive carrying out similar conformity assessment activities covering the same products with relevant information on issues relating to negative and, on request, positive conformity assessment results.

§ 115 Information obligation on notified bodies

Notified bodies have specific information obligations with regard to their activities, to be provided to the notifying authorities by default or on their request.

The wording of Article 31.1(a) makes reference only to "certificates" issued by notified bodies according to the conformity assessment procedures established in the Directive: EU-type examination certificates (Annex III) and certificates of conformity (Annex V, Annex IX). Taking into consideration that notified bodies can issue also other documents – see [section § 109](#) – called "quality assurance notifications" (QAN), to notify to the manufacturer the decision on approval of quality assurance systems (Annex IV, Annex VII), the legal provision should be intended as addressed to the whole range of activities and documents issued by notified bodies when carrying out the relevant conformity assessment procedures. So, the obligation of information of any refusal, restriction, suspension or withdrawal of a certificate is valid also for the "quality assurance notifications" issued by notified bodies (see also § 5.2.2. "Roles and responsibilities" in "[The 'Blue Guide' on the implementation of EU product rules](#)").

Also a notified body which gets knowledge of faulty products, but is neither engaged in the module for EU-type examination nor in a module for surveillance of the manufacturer, should take some action.

If there is no immediate danger, if after contact with the responsible notified body for EU-type examination and with the notified body responsible for surveillance of the production of the faulty product no satisfactory solution after appropriate time is reached, the notified body should inform its own authorities in charge of market surveillance to initiate the adequate measures.

In the case of immediate danger, the notified body should inform its own authority in charge of market surveillance, the notified body for EU-type examination and the notified body for surveillance of the production without delay.

Article 32
Exchange of experience

The Commission shall provide for the organisation of exchange of experience between the Member States' national authorities responsible for notification policy.

§ 116 Exchange of experience

This kind of activity is usually carried out in the framework of the activities of horizontal/inter-sectoral working parties organized by the Commission with Member States representatives, such as the *Internal Market for Products - Market Surveillance Group (IMP-MSG)* and the *Internal Market for Products - Expert Group for Accreditation and Conformity Assessment*, as well as within the sectoral Administrative Co-operation Group (ATEX AdCo).

In particular, the ATEX AdCo Group is integrated by representatives of the national authorities of the EU Member States in charge of market surveillance activities. They usually meet twice a year to inform about, discuss and interchange experiences and practices, and to make proposals to be submitted to the working parties under the ATEX Directive 2014/34/EU. Communications take place also through a specific Interest Group on the CIRCABC system.

All these activities receive specific support by the Commission.

Article 33
Coordination of notified bodies

The Commission shall ensure that appropriate coordination and cooperation between bodies notified under this Directive are put in place and properly operated in the form of a sectoral group of notified bodies.

Member States shall ensure that the bodies notified by them participate in the work of that group, directly or by means of designated representatives.

§ 117 Coordination of notified bodies. The European ATEX Notified Bodies Group (ExNBG)

All notified bodies are required to participate in appropriate co-ordination activities. Under the ATEX Directive 2014/34/EU (and already established and active under the previous Directive 94/9/EC) there is the European ATEX Notified Bodies Group (ExNBG).

The ExNBG is run by notified bodies in accordance with Article 33 of the ATEX Directive 2014/34/EU in order to assist in achieving a uniform application of the Directive. While it is independent of the ATEX Committee and Working Group, it nonetheless needs to work closely with those bodies and with the European Commission services, all of which have a responsibility for the effective and uniform application of the Directive.

The ExNBG plays an important role as coordinator of notified bodies, as well as technical reference and feedback to the standardisers. The group normally meets annually and is made up of representatives of notified bodies with observers from the Commission, manufacturers and users' trade associations, standards-making bodies and other invitees. Attendance at each meeting is by invitation and any party wishing to be considered should contact the Chairperson of the group either through the Commission or via a notified body of your country.

The group is responsible for discussing issues of a technical nature to ensure that the technical provisions of the Directive and harmonised standards are applied in a uniform way. The group issues specific guidance documents called "Clarification Sheets" where ambiguities exist in technical procedures and also issues technical guidance documents where less detailed specifications require amplification.

Communication between ATEX notified bodies is also ensured by a specific Interest Group on the [CIRCABC](https://circabc.europa.eu/w/browse/33b0bed8-1c65-4d9e-b857-1f34d2d91c04) information system: the "ATEX Group of Notified Bodies" on <https://circabc.europa.eu/w/browse/33b0bed8-1c65-4d9e-b857-1f34d2d91c04>. It is required that all the notified bodies listed on NANDO must have at least one representative member of the Interest Group on CIRCABC.

See also § 5.2.4. "Coordination between notified bodies" in "[The 'Blue Guide' on the implementation of EU product rules](#)".

§ 118 Status and use of ExNBG Clarification Sheets issued by the European ATEX Notified Bodies Group

ExNBG Clarification Sheets are not legally binding but are administrative decisions taken by the European ATEX Notified Bodies Group (ExNBG) in order to minimise divergent interpretation by notified bodies of the technical requirements of the ATEX Directive.

According to Article 21(11) of the ATEX Directive 2014/34/EU, the ExNBG Clarification Sheets shall be applied as general guidance by each notified body i.e. the principle must always be followed and the details of the decision implemented as far as possible. This is because the notified bodies are required to keep "the highest degree of technical competence", by following the technical progress or the "state of the art" and participating in coordination.

For other interested parties, ExNBG Clarification Sheets should be considered as voluntary guidance to the practical application of the Directive, as an "expert opinion" related to the technical progress or the "state of the art", coming from qualified representatives of notified bodies. In other words, ExNBG Clarification Sheets could be regarded as useful practical recommendations, at the same level of "Recommendation for Use Sheets" issued by European co-ordinations of notified bodies under other harmonisation legislation such as Machinery, Lifts, Personal Protective Equipment, etc.

In any case, the use of ExNBG Clarification Sheets cannot be considered a proof concerning health and safety requirements of the ATEX Directive 2014/34/EU. European harmonised standards give presumption of conformity with the essential requirements of the directive, but not ExNBG Clarification Sheets.

ExNBG Clarification Sheets can be endorsed or "noted" by the ATEX Committee or Working Group as guidance documents, by recognising their importance and utility in order to provide expert interpretation guidance, not only to notified bodies, but also to manufacturers and other interested parties. The "noting" process is carried out by the ATEX Working Group through a "Written Procedure" via the relevant Interest Group on CIRCABC or, at request of Committee Members (by introducing comments, remarks etc.), by using an "Oral Procedure" at the Working Group meetings.

"Noted" ExNBG Clarification Sheets, as such, are made publicly available on the Commission website on

<http://ec.europa.eu/DocsRoom/documents/9568/attachments/1/translations/en/renditions/native>.

Those Clarification Sheets which are **not** noted by the ATEX Committee but needed for the work of ExNBG are also available in the internet but in an external private website, for information purpose only:

http://www.vdtuev.de/themen/industrie_und_anlagensicherheit/brand_und_exschutz/clarification-sheets-of-exnb.

The content of specific ExNBG Clarification Sheets could be proposed to draft a "Consideration Paper" by the ATEX Committee and/or to be included into the ATEX Guidelines. In this case, the ExNBG withdraws the relevant Clarification Sheets.

It is important to remark that, in any case, "noting" by the ATEX Committee or Working Group is not necessary for an ExNBG Clarification Sheet to be used by the notified bodies, according to its purpose and scope, and taking into due account the above considerations.

CHAPTER 5

UNION MARKET SURVEILLANCE, CONTROL OF PRODUCTS ENTERING THE UNION MARKET AND UNION SAFEGUARD PROCEDURE

§ 119 EU market surveillance, control of products entering the EU market and EU safeguard procedure

Chapter 5 of the ATEX Directive 2014/34/EU deals with EU market surveillance, control of products entering the EU market and the EU safeguard procedure.

See also § 7. "Market surveillance" in "[The 'Blue Guide' on the implementation of EU product rules](#)".

Article 34

Union market surveillance and control of products entering the Union market

Article 15(3) and Articles 16 to 29 of Regulation (EC) No 765/2008 shall apply to products covered by Article 1 of this Directive.

§ 120 EU market surveillance and control of products entering the Union market

The referred articles of the [Regulation \(EC\) No 765/2008](#), setting out requirements for accreditation and market surveillance relating to the marketing of products, are included into Chapter III: "Community [read 'Union'] market surveillance framework and controls of products entering the Community market". Regarding the ATEX Directive 2014/34/EU, they apply to the products falling into its scope: equipment and protective systems; safety devices, controlling devices and regulating devices; and components.

See also § 7.3. "Control of products from third countries by customs" in "[The 'Blue Guide' on the implementation of EU product rules](#)".

Article 35

Procedure for dealing with products presenting a risk at national level

1. Where the market surveillance authorities of one Member State have sufficient reason to believe that a product presents a risk to the health or safety of persons or to domestic animals or property, they shall carry out an evaluation in relation to the product concerned covering all relevant requirements laid down in this Directive. The relevant economic operators shall cooperate as necessary with the market surveillance authorities for that purpose.

Where, in the course of the evaluation referred to in the first subparagraph, the market surveillance authorities find that the product does not comply with the requirements laid down in this Directive, they shall without delay require the relevant economic operator to take all appropriate corrective actions to bring the product into compliance with those requirements, to withdraw the product from the market, or to recall it within a reasonable period, commensurate with the nature of the risk, as they may prescribe.

The market surveillance authorities shall inform the relevant notified body accordingly.

Article 21 of Regulation (EC) No 765/2008 shall apply to the measures referred to in the second subparagraph of this paragraph.

2. Where the market surveillance authorities consider that non-compliance is not restricted to their national territory, they shall inform the Commission and the other Member States of the results of the evaluation and of the actions which they have required the economic operator to take.

3. The economic operator shall ensure that all appropriate corrective action is taken in respect of all the products concerned that it has made available on the market throughout the Union.

4. Where the relevant economic operator does not take adequate corrective action within the period referred to in the second subparagraph of paragraph 1, the market surveillance authorities shall take all appropriate provisional measures to prohibit or restrict the products being made available on their national market, to withdraw the product from that market or to recall it.

The market surveillance authorities shall inform the Commission and the other Member States, without delay, of those measures.

5. The information referred to in the second subparagraph of paragraph 4 shall include all available details, in particular the data necessary for the identification of the non-compliant product, the origin of the product, the nature of the non-compliance alleged and the risk involved, the nature and duration of the national measures taken and the arguments put forward by the relevant economic operator. In particular, the market surveillance authorities shall indicate whether the non-compliance is due to either of the following:

- (a) failure of the product to meet requirements relating to the health or safety of persons or to the protection of domestic animals or property; or
- (b) shortcomings in the harmonised standards referred to in Article 12 conferring a presumption of conformity.

6. Member States other than the Member State initiating the procedure under this Article shall without delay inform the Commission and the other Member States of any measures adopted and of any additional information at their disposal relating to the non-compliance of the product concerned, and, in the event of disagreement with the adopted national measure, of their objections.

7. Where, within three months of receipt of the information referred to in the second subparagraph of paragraph 4, no objection has been raised by either a Member State or the Commission in respect of a provisional measure taken by a Member State, that measure shall be deemed justified.

8. Member States shall ensure that appropriate restrictive measures, such as withdrawal of the product from the market, are taken in respect of the product concerned without delay.

§ 121 Procedure for dealing with products presenting a risk at national level

When a product presents a risk at national level, a detailed procedure is set up for the relevant Member State authorities in charge of market surveillance on their territory, with specific obligations for the concerned economic operators.

See also §§ 7.4.4. "Market surveillance procedures", 7.4.5. "Corrective measures - bans – withdrawals - recalls" and 7.4.6. "Sanctions" in "[The 'Blue Guide' on the implementation of EU product rules](#)".

Article 36

Union safeguard procedure

1. Where, on completion of the procedure set out in Article 35(3) and (4), objections are raised against a measure taken by a Member State, or where the Commission considers a national measure to be contrary to Union legislation, the Commission shall without delay enter into consultation with the Member States and the relevant economic operator or operators and shall evaluate the national measure. On the basis of the results of that evaluation, the Commission shall adopt an implementing act determining whether the national measure is justified or not.

The Commission shall address its decision to all Member States and shall immediately communicate it to them and to the relevant economic operator or operators.

2. If the national measure is considered justified, all Member States shall take the necessary measures to ensure that the non-compliant product is withdrawn from their market, and shall inform the Commission accordingly. If the national measure is considered unjustified, the Member State concerned shall withdraw that measure.

3. Where the national measure is considered justified and the non-compliance of the product is attributed to shortcomings in the harmonised standards referred to in point (b) of Article 35(5) of this Directive, the Commission shall apply the procedure provided for in Article 11 of Regulation (EU) No 1025/2012.

§ 122 EU safeguard procedure

The safeguard clause referred to in Article 36 of the Directive 2014/34/EU is the EU procedure whereby any measure taken by a Member State, on the grounds of non-compliance with the essential health and safety requirements and where it is deemed that equipment is liable to endanger persons, animals or property for the purpose of withdrawing from the market, prohibiting the placing on the market or restricting the free movement of equipment accompanied by one of the means of attestation provided for in the Directive and therefore bearing the CE marking, must be immediately notified to the Commission by the Member State which has taken it.

In considering whether the safeguard clause should be triggered, Member States and the respective enforcement authorities will need to consider whether the non-compliance is substantial or can be considered a formal non-compliance to be resolved without recourse to the procedures enabled via the safeguard mechanism.

For example, a formal non-compliance could consist of illegibility of the CE marking. In such cases, the Member State could issue a compliance notice to the manufacturer or authorised representative or take other actions allowed by national legislation to encourage the responsible person(s) to take appropriate corrective action.

Member States will need to consider in each case whether the non-compliance is liable to endanger persons, animals or property and if the safeguard clause is the most effective means of ensuring the safety of persons, animals or property, which remains paramount under this section of the Directive.

Where objections are raised against a measure taken by a Member State, or where the Commission considers a national measure to be contrary to Union legislation, the Commission must carry out a process of consultation with the parties concerned, it is to say, the Member States, the manufacturer or his authorised representative established within the EU or, failing them, the person who placed the product on the EU market.

The consultation procedure enables the Commission to assess whether the restrictive measure is justified or not, on the basis of the information provided by the notifying authorities, as well as the positions of all the parties concerned, in particular regarding the reasons why the essential health and safety requirements laid down in the Directive have not been complied with by the product concerned.

Where the Commission finds, following such consultation, that the measures are justified, it informs all the parties concerned. All the Member States must take appropriate measures to ensure that the non-compliant product is withdrawn from their market. On the contrary, if the national measure is considered unjustified, the Member State concerned must withdraw that measure and immediately take the appropriate action to re-establish the free movement of the products in question on its territory.

See also § 7.5.1. "Safeguard mechanisms" in ["The 'Blue Guide' on the implementation of EU product rules"](#).

Article 37

Compliant products which present a risk

1. Where, having carried out an evaluation under Article 35(1), a Member State finds that although a product is in compliance with this Directive, it presents a risk to the health or safety of persons or to domestic animals or property, it shall require the relevant economic operator to take all appropriate measures to ensure that the product concerned, when placed on the market, no longer presents that risk, to withdraw the product from the market or to recall it within a reasonable period, commensurate with the nature of the risk, as it may prescribe.
2. The economic operator shall ensure that corrective action is taken in respect of all the products concerned that he has made available on the market throughout the Union.
3. The Member State shall immediately inform the Commission and the other Member States. That information shall include all available details, in particular the data necessary for the identification of the product concerned, the origin and the supply chain of the product, the nature of the risk involved and the nature and duration of the national measures taken.
4. The Commission shall without delay enter into consultation with the Member States and the relevant economic operator or operators and shall evaluate the national measures taken. On the basis of the results of that evaluation, the Commission shall decide by means of implementing acts whether the national measure is justified or not, and where necessary, propose appropriate measures.

The implementing acts referred to in the first subparagraph of this paragraph shall be adopted in accordance with the examination procedure referred to in Article 39(3).

On duly justified imperative grounds of urgency relating to the protection of health and safety of persons or to the protection of domestic animals or property, the Commission shall adopt immediately applicable implementing acts in accordance with the procedure referred to in Article 39(4).

5. The Commission shall address its decision to all Member States and shall immediately communicate it to them and the relevant economic operator or operators.

§ 123 Compliant products which present a risk

A specific procedure is provided for products compliant with the requirements of the Directive but nevertheless they present a health and safety risk. The relevant national authority has to take appropriate action, involving the concerned economic operators, and must inform the Commission and the other Member States. The Commission has to duly analyse the case and issue an implementing decision on whether the national measure adopted is justified or not.

Article 38

Formal non-compliance

1. Without prejudice to Article 35, where a Member State makes one of the following findings, it shall require the relevant economic operator to put an end to the non-compliance concerned:

- (a) the CE marking has been affixed in violation of Article 30 of Regulation (EC) No 765/2008 or of Article 16 of this Directive;
- (b) the CE marking, where required, has not been affixed;
- (c) the specific marking of explosion protection , the symbols of the equipment group and category and, where applicable, the other markings and information have been affixed in violation of point 1.0.5 of Annex II or have not been affixed;
- (d) the identification number of the notified body, where that body is involved in the production control phase, has been affixed in violation of Article 16 or has not been affixed;
- (e) the EU declaration of conformity or the attestation of conformity, as appropriate, does not accompany the product;
- (f) the EU declaration of conformity or, where required, the attestation of conformity has not been drawn up correctly;
- (g) technical documentation is either not available or not complete;
- (h) the information referred to in Article 6(7) or Article 8(3) is absent, false or incomplete;
- (i) any other administrative requirement provided for in Article 6 or Article 8 is not fulfilled.

2. Where the non-compliance referred to in paragraph 1 persists, the Member State concerned shall take all appropriate measures to restrict or prohibit the product being made available on the market or ensure that it is recalled or withdrawn from the market.

§ 124 Formal non-compliance

Non-compliance of a product is considered as formal when it is not directly related to a health and safety risk, but it could be an indicator of possible risks.

The cases listed in Article 38(1) include defects in markings, documents and other information to be provided with the product.

CHAPTER 6 COMMITTEE, TRANSITIONAL AND FINAL PROVISIONS

§ 125 Committee, transitional and final provisions

Chapter 6 of the ATEX Directive 2014/34/EU includes the provisions on the ATEX Committee, the enforcement measures by Member States (penalties) and the transitional and final provisions.

Article 39 **Committee procedure**

1. The Commission shall be assisted by the Committee on equipment and protective systems intended for use in potentially explosive atmospheres. That committee shall be a committee within the meaning of Regulation (EU) No 182/2011.

2. Where reference is made to this paragraph, Article 4 of Regulation (EU) No 182/2011 shall apply.

3. Where reference is made to this paragraph, Article 5 of Regulation (EU) No 182/2011 shall apply.

4. Where reference is made to this paragraph, Article 8 of Regulation (EU) No 182/2011, in conjunction with Article 5 thereof, shall apply.

5. The committee shall be consulted by the Commission on any matter for which consultation of sectoral experts is required by Regulation (EU) No 1025/2012 or by any other Union legislation.

The committee may furthermore examine any other matter concerning the application of this Directive raised either by its chair or by a representative of a Member State in accordance with its rules of procedure.

§ 126 The ATEX Committee

As indicated in Recitals 45, 46 and 47, the ATEX Committee has a specific role in examining different questions related to the implementation, application and management of the Directive.

[Regulation \(EU\) No 182/2011](#) (the "Comitology Regulation") establishes the rules and general principles concerning mechanisms for control by Member States of the Commission's exercise of implementing powers. In its Article 3 "Common provisions" it defines the role and composition of committees; when Article 4 deals with the "Advisory procedure" and Article 5 with the "Examination procedure", also in conjunction with Article 8 on "Immediately applicable implementing acts".

Reference to [Regulation \(EU\) No 1025/2012](#) on European standardisation recalls consultation of sectoral experts on matters regarding requests for European standards or objections to harmonised standards.

The ATEX Committee sets up its own rules of procedure and it is chaired by the Commission and integrated by the representatives of EU Member States. The ATEX Committee creates the ATEX Working Group enlarged to other EU-wide interested parties, such as standards makers, notified bodies, industry, trade unions, consumers etc.

Article 40
Penalties

Member States shall lay down rules on penalties applicable to infringements by economic operators of the provisions of national law adopted pursuant to this Directive and shall take all measures necessary to ensure that they are enforced. Such rules may include criminal penalties for serious infringements.

The penalties provided for shall be effective, proportionate and dissuasive.

§ 127 Enforcement: penalties

As indicated in Recital 48, national authorities of EU Member States in charge of enforcement of the provisions of the ATEX Directive 2014/34/EU (the market surveillance authorities) must be able to impose appropriate penalties if those provisions are not correctly applied. Such penalties must be foreseen by the national legislative acts transposing the provisions of the Directive into national law.

Article 41
Transitional provisions

1. Member States shall not impede the making available on the market or the putting into service of products covered by Directive 94/9/EC which are in conformity with that Directive and which were placed on the market before 20 April 2016.
2. Certificates issued under Directive 94/9/EC shall be valid under this Directive.

§ 128 Transitional provisions

Products placed on the market before the date of applicability of Directive 2014/34/EU, in conformity with the applicable Directive 94/9/EC, can continue circulating on the EU market.

Regarding certificates issued under Directive 94/9/EC before 20 April 2016, they remain valid under the ATEX Directive 2014/34/EU. Therefore the manufacturer must inform the notified body that holds the technical documentation relating to the EC-type examination certificates validly issued under Directive 94/9/EC of all modifications to the approved type that may affect the conformity of the product with the essential health and safety requirements of this Directive or the conditions for validity of that certificate. Such modifications could require an additional approval in the form of a new EU-type examination certificate to be issued under Directive 2014/34/EU.

More detailed information on horizontal and vertical transitional issues can be found in the "Guidance document on the ATEX Directive transition from 94/9/EC to 2014/34/EU", available on the ATEX website <http://ec.europa.eu/DocsRoom/documents/13132/attachments/1/translations/en/renditions/native>.

Article 42 **Transposition**

1. Member States shall adopt and publish by 19 April 2016 the laws, regulations and administrative provisions necessary to comply with Article 1, points 2 and 8 to 26 of Article 2, Article 3, Articles 5 to 41 and Annexes III to X. They shall forthwith communicate the text of those measures to the Commission.

They shall apply those measures from 20 April 2016.

When Member States adopt those measures, they shall contain a reference to this Directive or be accompanied by such a reference on the occasion of their official publication. They shall also include a statement that references in existing laws, regulations and administrative provisions to the Directive repealed by this Directive shall be construed as references to this Directive. Member States shall determine how such reference is to be made and how that statement is to be formulated.

2. Member States shall communicate to the Commission the text of the main provisions of national law which they adopt in the field covered by this Directive.

§ 129 Transposition

The legal acts to be adopted and published by 19 April 2016 (the day before the applicability of the ATEX Directive 2014/34/EU) transposing the Directive into the national legislation of each EU Member State must comply with the following provisions:

- "scope" (Article 1),

- definitions of "protective systems", "equipment category", "intended use", "making available on the market", "placing on the market", "manufacturer", "authorised representative", "importer", "distributor", "economic operators", "technical specification", "harmonised standard", "accreditation", "national accreditation body", "conformity assessment", "conformity assessment body", "recall", "withdrawal", "Union harmonisation legislation", "CE marking" (Article 2, points (2) and (8) to (26)),
- "making available on the market and putting into service" (Article 3),
- "free movement", "obligations of economic operators", "conformity of the product", "notification of conformity assessment bodies", "union market surveillance, control of products entering the Union market and Union safeguard procedure", "committee procedure", "penalties", "transitional provisions" (Articles 5 to 41),
- conformity assessment procedures (Annexes III to IX), and
- model for EU declaration of conformity (Annex X),

The texts of those legal measures (as laws, regulations, administrative provisions etc.) must be communicated to the Commission.

Article 43

Repeal

Directive 94/9/EC, as amended by the Regulations listed in Annex XI, Part A, is repealed with effect from 20 April 2016, without prejudice to the obligations of the Member States relating to the time-limits for transposition into national law and the dates of application of the Directive set out in Annex XI, Part B.

References to the repealed Directive shall be construed as references to this Directive and shall be read in accordance with the correlation table in Annex XII.

§ 130 Repeal

The new ATEX Directive 2014/34/EU repeals the previous Directive 94/9/EC on 20 April 2016. Taking into consideration that the new act is the result of the alignment and recast of the previous one, references to Directive 94/9/EC remaining after the repeal date have to be considered as references to Directive 2014/34/EU, according to the correlation table in Annex XII.

Article 44

Entry into force and application

This Directive shall enter into force on the twentieth day following that of its publication in the *Official Journal of the European Union*.

Points 1 and 3 to 7 of Article 2, Article 4 and Annexes I, II, XI and XII shall apply from 20 April 2016.

§ 131 Entry into force and application

As the ATEX Directive 2014/34/EU was published in the Official Journal of the European Union (OJEU) on 29 March 2014, it entered into force on 18 April 2014. This concern in particular the provisions indicated in Article 42(1) as the object of transposition of the Directive by the EU Member States into their national legislation (see section [§ 129](#)).

On the contrary, the provisions related to:

- definitions of "equipment", "components", "explosive atmosphere", "potentially explosive atmosphere", "equipment-group I" and "equipment-group II" (Article 2, points (1) and (3) to (7)),
- "essential health and safety requirements" (Article 4),
- "criteria determining the classification of equipment-groups into categories" (Annex I),
- "essential health and safety requirements relating to the design and construction of equipment and protective systems intended for use in potentially explosive atmospheres" (Annex II), and
- "repealed Directive" and "correlation table" (Annexes XI and XII),

even if they are in force since 18 April 2014, too, they are applicable from 20 April 2016 (2 years after the entry into force of the Directive).

This means that the ATEX Directive 2014/34/EU can be used to place products on the EU market with the relevant conformity assessment procedures etc. only from 20 April 2016. Before that date, the previous Directive 94/9/EC still applies.

Article 45 **Addressees**

This Directive is addressed to the Member States.

Done at Strasbourg, 26 February 2014.

For the European Parliament

For the Council

The President

The President

M. SCHULZ

D. KOURKOULAS

§ 132 Addresses and signatories of the Directive

The Directive is addressed to the Member States, since the transposition of the provisions of the Directive into national law is necessary in order to create binding legal obligations for the economic operators.

The Directive is signed by the Presidents of the European Parliament and of the Council at the date, since it was adopted by these EU Institution according to the ordinary legislative procedure (formerly known as "co-decision") set out in Article 294 of the TFEU (see also section [§ 2](#) on the legal basis of the ATEX Directive).

THE ANNEXES TO THE ATEX DIRECTIVE

ANNEX I

CRITERIA DETERMINING THE CLASSIFICATION OF EQUIPMENT-GROUPS INTO CATEGORIES

§ 133 Classification of equipment-groups into categories

The ATEX Directive 2014/34/EU divides equipment into two groups. In order to determine the appropriate conformity assessment procedure, the manufacturer must first come to a decision based on the intended use, as to which group and category the product belongs.

It should be noted that devices have to follow the conformity assessment procedure according to the category of the equipment or protective system they are required for or contribute to. Devices and components may be suitable for one or more category or group of equipment.

- Equipment-group I comprises equipment intended for use in the underground parts of mines, and to those parts of surface installations of such mines, likely to become endangered by firedamp and/or combustible dust.
- Equipment-group II comprises equipment intended for use in other places likely to become endangered by explosive atmospheres.

These groups are sub-divided into categories. The way in which this categorisation has been developed highlights one of the main distinctions of equipment-group I and II. For group I, the categorisation depends on (amongst other factors) whether the product is to be de-energised in the event of an explosive atmosphere occurring. For group II, it depends where the product is intended to be used in and whether a potentially explosive atmosphere, is always present, or is likely to occur for a long or a short period of time.

The various categories of equipment must be capable of functioning in conformity with the operational parameters established by the manufacturer to a certain level of protection – see below **Table 5: Levels of protection**.

Such table makes references to the concept of "zone" as defined in the ATEX "workplace" [Directive 1999/92/EC](#) and it is based on the "normal" correspondence according to it. It should be noted that, when the group and category are a defined property of the equipment according to the ATEX "product" Directive 2014/34/EU, the zone is a defined property of the physical location and likelihood of an explosive atmosphere being present. Directive 1999/92/EC provides a "normal" correspondence between the zone and the category of equipment that may be installed in the zone. However, it also provides for varying this relationship according to a detailed risk assessment and also allows for the possibility that, in implementing Directive 1999/92/EC, individual Member States, may have changed the "normal" correspondence for particular situations.

Table 5: Levels of protection

LEVEL OF PROTECTION	CATEGORY GROUP		PERFORMANCE OF PROTECTION	CONDITIONS OF OPERATION (*)
	I	II		
Very High	M 1		Two independent means of protection or safe even when two faults occur independently of each other.	Equipment remains energised and functioning when explosive atmosphere present.
Very High		1	Two independent means of protection or safe even when two faults occur independently of each other.	Equipment remains energised and functioning in zones 0, 1, 2 (G) and/or 20, 21, 22 (D).
High	M 2		Suitable for normal operation and severe operating conditions. If applicable also suitable for frequently occurring disturbances or for faults which are normally taken into account.	Equipment de-energised when explosive atmosphere is recognised.
High		2	Suitable for normal operation and frequently occurring disturbances or equipment where faults are normally taken into account.	Equipment remains energised and functioning in zones 1, 2 (G) and/or 21, 22 (D).
Normal		3	Suitable for normal operation.	Equipment remains energised and functioning in zone 2 (G) and/or 22 (D).

(*) See as well the directives on minimum requirements for improving the safety and health protection of workers operating in potentially explosive atmospheres, e.g. those indicated in footnote 7 in the "Introduction". The equipment in the various categories must also comply with the relevant essential and supplementary requirements detailed in Annex II to the Directive (essential health and safety requirements).

1. Equipment-group I

- (a) Equipment category M 1 comprises equipment designed and, where necessary, equipped with additional special means of protection to be capable of functioning in conformity with the operational parameters established by the manufacturer and ensuring a very high level of protection.

Equipment in this category is intended for use in underground parts of mines as well as those parts of surface installations of such mines endangered by firedamp and/or combustible dust.

Equipment in this category is required to remain functional, even in the event of rare incidents relating to equipment, with an explosive atmosphere present, and is characterized by means of protection such that:

- either, in the event of failure of one means of protection, at least an independent second means provides the requisite level of protection,
- or the requisite level of protection is assured in the event of two faults occurring independently of each other.

Equipment in this category must comply with the supplementary requirements referred to in point 2.0.1 of Annex II.

§ 134 Equipment-group I, category M1

Products of this category are required to remain functional for safety reasons when an explosive atmosphere is present and are characterised by integrated explosion protection measures functioning in such a way that:

- in the event of failure of one integrated measure, at least a second means of protection provides for a sufficient level of safety; or,
- in the event of two faults occurring independently of each other, a sufficient level of safety is ensured.

Products relating to this category must also comply with the supplementary requirements as detailed in Annex II, paragraph 2.0.1 to Directive 2014/34/EU.

Examples of equipment that might be categorised M1 include:

- gas detection system equipment;
- communications equipment;
- equipment used for mine rescue purposes.

All the above may be required to continue operating for safety reasons if an explosive atmosphere has been detected.

(b) Equipment category M 2 comprises equipment designed to be capable of functioning in conformity with the operational parameters established by the manufacturer and ensuring a high level of protection.

Equipment in this category is intended for use in underground parts of mines as well as those parts of surface installations of such mines likely to be endangered by firedamp and/or combustible dust.

This equipment is intended to be de-energized in the event of an explosive atmosphere.

The means of protection relating to equipment in this category assure the requisite level of protection during normal operation and also in the case of more severe operating conditions, in particular those arising from rough handling and changing environmental conditions.

Equipment in this category must comply with the supplementary requirements referred to in point 2.0.2 of Annex II.

§ 135 Equipment-group I, category M2

These products are intended to be de-energised in the event of an explosive atmosphere being detected.

It is nonetheless foreseeable that explosive atmospheres could occur during the operation of category M2 equipment, as the equipment might not be de-energised immediately the atmosphere is detected. It is therefore necessary to incorporate protection measures, which provide a high level of safety. The protection measures relating to products of this category provide a sufficient level of safety during normal

operation even in the event of more severe operating conditions arising, from rough handling and changing environmental conditions. This normally also includes the requirement to provide equipment with a sufficient level of safety in the event of operating faults or in dangerous operating conditions which normally have to be taken into account.

Products relating to this category must also comply with the supplementary requirements as detailed in Annex II, paragraph 2.0.2 to Directive 2014/34/EU.

2. Equipment-group II

- (a) Equipment category 1 comprises equipment designed to be capable of functioning in conformity with the operational parameters established by the manufacturer and ensuring a very high level of protection.

Equipment in this category is intended for use in areas in which explosive atmospheres caused by mixtures of air and gases, vapours or mists or by air/dust mixtures are present continuously, for long periods or frequently.

Equipment in this category must ensure the requisite level of protection, even in the event of rare incidents relating to equipment, and is characterized by means of protection such that:

- either, in the event of failure of one means of protection, at least an independent second means provides the requisite level of protection,
- or the requisite level of protection is assured in the event of two faults occurring independently of each other.

Equipment in this category must comply with the supplementary requirements referred to in point 2.1 of Annex II.

§ 136 *Equipment-group II, category 1*

This category comprises products designed to be capable of remaining within their operational parameters, stated by the manufacturer, and ensuring a very high level of protection for their intended use in areas in which explosive atmospheres caused by mixtures of air and gases, vapours, mists or air/dusts mixtures are **highly likely** to occur and are present continuously, for long periods of time or frequently.

Equipment of this category is characterised by integrated explosion protection measures functioning in such a way that:

- in the event of a failure of one integrated measure, at least a second independent means of protection provides for a sufficient level of safety; or,
- in the event of two faults occurring independently of each other a sufficient level of safety is ensured.

It is also considered that equipment may be classed as category 1, if the manufacturer provides a combination of protective measures to prevent an ignition source becoming active under fault conditions, and in addition an integrated

protective system (see section [§ 45](#)) which will control the ignition hazard from a rare malfunction of the equipment.

Products relating to this category must also comply with the supplementary requirements as detailed in Annex II, paragraph 2.1 to Directive 2014/34/EU.

(b) Equipment category 2 comprises equipment designed to be capable of functioning in conformity with the operational parameters established by the manufacturer and of ensuring a high level of protection.

Equipment in this category is intended for use in areas in which explosive atmospheres caused by gases, vapours, mists or air/dust mixtures are likely to occur occasionally.

The means of protection relating to equipment in this category ensure the requisite level of protection, even in the event of frequently occurring disturbances or equipment faults which normally have to be taken into account.

Equipment in this category must comply with the supplementary requirements referred to in point 2.2 of Annex II.

§ 137 Equipment-group II, category 2

This category comprises products designed to be capable of remaining within their operational parameters, stated by the manufacturer, and based on a high level of protection for their intended use, in areas in which explosive atmospheres caused by mixtures of air and gases, vapours, mists or air/dust mixtures are likely to occur.

The explosion protection relating to this category must function in such a way as to provide a sufficient level of safety even in the event of equipment with operating faults or in dangerous operating conditions which normally have to be taken into account.

Products relating to this category must also comply with the supplementary requirements as detailed in Annex II, paragraph 2.2 to Directive 2014/34/EU.

(c) Equipment category 3 comprises equipment designed to be capable of functioning in conformity with the operating parameters established by the manufacturer and ensuring a normal level of protection.

Equipment in this category is intended for use in areas in which explosive atmospheres caused by gases, vapours, mists, or air/dust mixtures are unlikely to occur or, if they do occur, are likely to do so only infrequently and for a short period only.

Equipment in this category ensures the requisite level of protection during normal operation.

Equipment in this category must comply with the supplementary requirements referred to in point 2.3 of Annex II.

§ 138 Equipment-group II, category 3

This category comprises products designed to be capable of keeping within its operational parameters, stated by the manufacturer, and based upon a normal level of protection for its intended use, considering areas in which explosive atmospheres caused by mixtures of air and gases, vapours, mists or air/dust mixtures are unlikely to occur and if they do occur, do so infrequently and for a short period of time only.

The design of the products of this category must provide a sufficient level of safety during normal operation.

Products relating to this category must also comply with the supplementary requirements as detailed in Annex II, paragraph 2.3 to Directive 2014/34/EU.

Care needs to be taken in assuming what is meant by "normal operation". For example, normal operation of a luminaire in an industrial application is assumed to include operation with a failed lamp since it is common practice for installations with multiple luminaires on a single circuit to operate for protracted periods with one or more failed lamps. Additional information is usually provided in the relevant European harmonised standards.

See also section [§ 254](#) on motor protection for category 3 motors.

ANNEX II

ESSENTIAL HEALTH AND SAFETY REQUIREMENTS RELATING TO THE DESIGN AND CONSTRUCTION OF EQUIPMENT AND PROTECTIVE SYSTEMS INTENDED FOR USE IN POTENTIALLY EXPLOSIVE ATMOSPHERES

§ 139 Essential health and safety requirements

Annex II to the ATEX Directive 2014/34/EU provides an overview of the essential health and safety requirements (EHSRs) to be adopted to avoid the risk of explosion. Although direct application of the EHSRs is possible, it is envisaged that the normal route to demonstrate conformity with the EHSRs will be to conform to the requirements given in one or more European harmonised standards (see [section § 61](#)). If European harmonised standards are not used, it is incumbent on the person declaring conformity to state the technical basis for such a declaration, including evidence of any research that might have been undertaken in order to prove the equivalence of the protective measures undertaken.

Preliminary observations

- A. Technological knowledge, which can change rapidly, must be taken into account as far as possible and be utilized immediately.

- B. For the devices referred to in point (b) of Article 1(1), the essential health and safety requirements shall apply only in so far as they are necessary for the safe and reliable functioning and operation of those devices with respect to the risks of explosion.

§ 140 Preliminary observations

Preliminary observation "A" is often referred to as requiring conformity with the "state of the art". Although the generalised text of the EHSRs does not change, the European harmonised standards interpreting the EHSRs are subject to a continuous process of revision to take into account developments in technology and further developments in knowledge about explosion protection.

Therefore, the relevant current harmonised standards would be regarded as demonstrating "state of the art" for a particular type of protection. Use of a non-harmonised standard may be possible, but its use must be justified.

Further information on issues relating to "state of the art" and EU-type examination certificates can be found in the Clarification Sheet ExNB/10/397/CS issued by the European Coordination of ATEX Notified Bodies Group (ExNBG), available on <http://ec.europa.eu/DocsRoom/documents/9568/attachments/1/translations/en/renditions/native>.

Preliminary observation "B" indicates that safety devices, controlling devices and regulating devices – referenced in Article 1(1)(b) – need only to comply with a restricted range of EHSRs and that conformity to the remaining EHSRs will be ascertained when the conformity of the complete equipment, incorporating the component, is assessed.

1. Common requirements for Equipment and protective systems

1.0. General requirements

§ 141 General requirements

In general terms, it can be stated that compliance with the essential health and safety requirements of Directive 2014/34/EU is imperative in order to ensure the explosion proofing of equipment and protective systems. The requirements are intended to take account of existing or potential hazards deriving from the design and construction. However, following the philosophy of the ATEX Directive 2014/34/EU within the "New Approach" and the [New Legislative Framework](#), the notion of intended use is of prime importance too. It is also essential that manufacturers supply full information.

1.0.1. Principles of integrated explosion safety

Equipment and protective systems intended for use in potentially explosive atmospheres must be designed from the point of view of integrated explosion safety.

In this connection, the manufacturer must take measures:

- above all, if possible, to prevent the formation of explosive atmospheres which may be produced or released by equipment and by protective systems themselves,
- to prevent the ignition of explosive atmospheres, taking into account the nature of every electrical and non-electrical source of ignition,
- should an explosion nevertheless occur which could directly or indirectly endanger persons and, as the case may be, domestic animals or property, to halt it immediately and/or to limit the range of explosion flames and explosion pressures to a sufficient level of safety.

1.0.2. Equipment and protective systems must be designed and manufactured after due analysis of possible operating faults in order as far as possible to preclude dangerous situations.

Any misuse which can reasonably be anticipated must be taken into account.

§ 142 Principles of integrated explosion safety. Risk assessment for ATEX products

To meet the requirements of Directive 2014/34/EU it is necessary to conduct a risk assessment process. According to Annex II, 1.0.1 manufacturers are under an obligation to design equipment and protective systems from the point of view of integrated explosion safety. Integrated explosion safety is conceived to prevent the formation of explosive atmospheres as well as sources of ignition and, should an explosion nevertheless occur, to halt it immediately and / or to limit its effects. In this connection, the manufacturer must take measures with respect to the risks of explosion. However, in most cases he will not be in the position to understand the possible extent of the adverse consequences of an explosion (as part of the overall explosion risk) since this is solely dependent on the particular circumstances at the users` premises. So the manufacturer's risk assessment will in general be restricted to and be focussed on the assessment of the ignition hazard (again part of the explosion risk) or the explosion control function for a protective system and safety devices. In addition, as required in Annex II, 1.0.2 to the Directive, equipment and protective systems must be designed and manufactured after due analysis of possible technical and operating faults in order as far as possible to preclude dangerous situations.

Bearing in mind the commitments resulting from the relevant requirements of Directive 2014/34/EU, a methodology on risk assessment, i.e. here ignition risk assessment, should not only deal with designing and construction aspects but also provide a common format or language between designers and users.

Methods and/or techniques that could be applied

There are many possible methods and/or techniques for risk assessment, especially for hazard identification. They can easily be adopted for the ignition risk assessment explained above as follows.

A product identification technique has the following attributes:

- it is systematic, i.e. it guides the parties concerned so that all parts of the system, all phases of use and all reasonably anticipated hazards are considered;
- it employs brainstorming.

By using more than one technique the possibility of overlooking any relevant hazard is minimised. However, the additional time employed in using more than one technique needs to be balanced against the increased confidence in the results. The main output from the hazard identification stage is a numbered listing of hazardous events, which could result from the products involved as an input to the risk estimation stage.

Risk assessment methodology should comprise the hazard profiles including the accidental parameters that can reasonably be anticipated. These aspects become subject to a risk assessment as a "series of logical steps to enable, in a systematic way, the examination of the hazards associated with products".

In principle the risk assessment comprises of four steps⁴⁰:

- 1) Hazard identification: a systematic procedure for finding all of the hazards, which are associated with the products. Once a hazard has been recognized, the design can be changed to minimise it, whether or not the degree of risk has been estimated. Unless the hazard is recognized it cannot be addressed in the design.
- 2) Risk estimation: determination of the probability of occurrence of the identified hazards (and of the levels of severity of the possible harm of the considered hazards)⁴¹.
- 3) Risk evaluation: comparison of the hazards estimated with criteria in order to decide whether the risk is acceptable or whether the product design must be modified in order to reduce the risk.
- 4) Risk reduction option analysis: the final step of risk assessment is the process of identifying, selecting and modifying design changes which might reduce the overall risk from products. Although risks can always be reduced further they can seldom be reduced to zero except by eliminating the activities.

Options, which address the hazardous events that make the greatest contributions to the total risk, have the greatest potential to reduce risk. Effectiveness in reducing risk always starts with changes to the design concept, i.e. inherently safe design.

See also §§ 4.1.1. "Definition of essential requirements", 4.1.2.2. "Role of harmonised standards" and 4.3. "Technical documentation" in "[The 'Blue Guide' on the implementation of EU product rules](#)".

⁴⁰ For further information on risk assessment, see EN 1127-1 *Explosive atmospheres - Explosion prevention and protection - Part 1: Basic concepts and methodology*. For worked examples, see EN ISO 80079-36 *Non-electrical equipment for explosive atmospheres - Basic method and requirements*.

⁴¹ See as well EN 15198 *Methodology for the risk assessment of non-electrical equipment and components for intended use in potentially explosive atmospheres* and EN ISO 14121-1 *Safety of machinery - Risk assessment - Part 1: Principles*).

1.0.3. Special checking and maintenance conditions

Equipment and protective systems subject to special checking and maintenance conditions must be designed and constructed with such conditions in mind.

1.0.4. Surrounding area conditions

Equipment and protective systems must be so designed and constructed as to be capable of coping with actual or foreseeable surrounding area conditions.

§ 143 *Special conditions: checking, maintenance, surrounding area*

Special conditions on checking, maintenance and the surrounding area for ATEX products are usually related to their intended use. In this sense it would be useful to ensure good communication between the manufacturer and the intended user of the product, in order to take into due consideration such conditions in the design and construction phases and to inform the users accordingly in terms of health and safety.

The surrounding area conditions may include:

- ambient temperature range;
- ambient moisture level;
- the effect of additional sources of heat or cooling (such as mounting on a heated process vessel);
- exposure to known chemical agents (including a salt atmosphere);
- exposure to vibration or other physical forces (including impact);
- exposure to light (particularly relevant for plastic materials).

1.0.5. Marking

All equipment and protective systems must be marked legibly and indelibly with the following minimum particulars:

- name, registered trade name or registered trade mark, and address of the manufacturer,
- CE marking (see Annex II to Regulation (EC) No 765/2008),
- designation of series or type,
- batch or serial number, if any,
- year of construction,
- the specific marking of explosion protection  followed by the symbol of the equipment group and category,
- for equipment-group II, the letter ‘G’ (concerning explosive atmospheres caused by gases, vapours or mists),

and/or

- the letter ‘D’ (concerning explosive atmospheres caused by dust).

Furthermore, where necessary, they must also be marked with all information essential to their safe use.

§ 144 Marking

As these ATEX Guidelines have been especially drafted to facilitate the application of Directive 2014/34/EU, the following explanations refer only to this Directive. If other directives are applicable in parallel, their provisions have to be taken into account in addition to those of Directive 2014/34/EU.

The ATEX Directive prescribes, within the essential health and safety requirements, a set of markings for equipment and protective systems, including in particular CE marking and other supplementary/specific marking.

See also § 4.5. "Marking requirements" in "[The 'Blue Guide' on the implementation of EU product rules](#)".

§ 145 CE Marking

See also section [§ 66](#) on CE marking.

[Regulation \(EC\) No 765/2008](#) lays down the definition, the format and the general principles governing the CE marking.

CE marking is used by the manufacturer as a declaration that he considers that the product in question has been manufactured in conformity with all applicable provisions and requirements of the ATEX Directive 2014/34/EU and that the product has been the subject of the appropriate conformity assessment procedures.

The CE marking is mandatory and must be affixed before any equipment or protective system is placed on the market or put into service. As stated in Article 13(3) components are excluded from this provision. Instead of being CE marked, components have to be delivered with a written attestation (*as indicated in section [§ 46](#) on components*) stating the conformity with the provisions of the Directive, stating their characteristics and indicating how they must be incorporated into equipment or protective systems. This separate statement goes along with the definition of components, which have as structural parts no autonomous function.

In general the CE marking must be affixed during the production control phase by the manufacturer or his authorised representative established within the European Union. In certain cases it is possible to affix the CE marking earlier, e.g. during the production phase of a complex product (e.g. a vehicle). It is then necessary that the manufacturer formally confirms the compliance of this product with the requirements of the Directive in the production control phase.

The CE marking must consist of the initials "CE" taking the form described in [Regulation \(EC\) No 765/2008](#). In general the CE marking must be affixed to the product or to its data plate. However, although it is not a requirement in Directive 2014/34/EU, it is considered reasonable to affix the CE marking to the packaging and to the accompanying documents if it is not possible to affix it to the product because of the product's size or nature.

It would be sensible, but it is not mandatory, to affix the CE marking to more than one place, for example, marking the outer packaging as well as the product inside, would mean that the marking can be ascertained without opening the package.

The CE marking shall be affixed distinctly, visibly, legibly and indelibly. It is prohibited to affix any marks or inscriptions that are likely to mislead third parties as to the meaning and form of the CE marking. The requirement for visibility means that the CE marking must be easily accessible for market surveillance authorities as well as visible for customers and users. For reasons of legibility a minimum height of 5 mm of the CE marking is required. This minimum dimension may be waived for small-scale products. The requirement for indelibility means that the marking must not be removed from the product without leaving traces noticeable under normal circumstances.

Depending on the conformity assessment procedure applied, a notified body may be involved in the design phase (Annex III), the production phase (Annexes IV, V, VI, VII, IX) or in both phases. The identification number of the notified body only has to accompany the CE marking if the body is involved in the production control phase. It is necessary to avoid any misleading information on equipment, for example the number of the notified body, where this is not foreseen by the Directive. Hence, the product should not have the number of a notified body affixed, if falling under category 3 (other than Unit verification), as well as some category 2 equipment, and for any voluntary certification.

The CE marking and the identification number of the notified body do not necessarily have to be affixed within the territory of the EU. These can be affixed in a third country if the product, for example, is manufactured there and the notified body either performed tests on the product type or assessed the quality assurance system of the manufacturer in that country. The CE marking and the identification number can also be affixed separately, so long as the CE and body-number remain combined. In case of components only the identification number of the notified body has to be affixed.

Where equipment that has already been placed on the market is incorporated into a product (e.g. a combined product or assembly – see [section § 44](#)), the integrated equipment must bear the CE marking and, if appropriate, the identification number of the notified body.

Whilst it is recognised that sub-assemblies may have CE marking affixed in their own right these might not be visible following construction of the final product. This is acceptable as this information can be found elsewhere. However, the final product must have a single label clearly relating to its final assembly prior to it being placed on the market and/or taken into service. In affixing the CE marking to the final product the manufacturer or his authorised representative accepts full responsibility for the

conformity of the final product to the applicable essential health and safety requirements of Directive 2014/34/EU and all other relevant European legislation.

§ 146 Supplementary/specific marking

It is the intention of Directive 2014/34/EU that the design of the specific marking of explosion protection  ("epsilon-x", or "the hexagon")⁴² follows the design, as specified in the old Directive 84/47/EEC (see page 231). This marking has to be followed by the symbol of the group and category (on devices according to Article 1(1)(b) of Directive 2014/34/EU the category should be indicated in brackets) and, relating to group II, the letter 'G' (concerning explosive atmospheres caused by gases, vapours or mists) and/or D (concerning explosive atmospheres caused by dust).







User instructions shall explain in detail the meaning of the marking on the product. However it is recommended to use the format provided in the following examples, as in **Tables 6 and 7**, where

" .. / .. " means the product has two different categories, and

".. - .. " means that a part of the product is not conforming to the Directive and not intended to be used in a potentially explosive atmosphere.

Moreover, devices according to Article 1(1)(b) of the Directive, and separately placed on the market, shall be marked with the category of the equipment under control in round brackets, and such devices which contain an own potential ignition source intended for use in a potential explosive atmosphere shall be marked as equipment according to Annex II clause 1.0.5.

Table 6: examples for marking of equipment

	I	M2	Mining products, group I, category M2
	II	1 G	Non-mining products, group II, category 1 for use in gas/vapour/mist atmospheres
	II	1 D	Non-mining products, group II, category 1 for use in dust atmospheres
			Protective system, for use in gas/vapour/mist/dust atmospheres
	II	(1) G D	Device according to Article 1(1)(b) of Directive 2014/34/EU in the non-hazardous area with intrinsically safe circuits of category "Ex ia", which can be connected e.g. to category 1 equipment
	II	2 GD	Category 2 equipment for use in potentially explosive atmosphere containing gases or dust

⁴² Not to be confused with the "Ex marking" for explosion protection in conformance with standards (as from the EN 60079 series), nor with the "Ex warning sign" as defined the ATEX "workplace" Directive 1999/92/EC.











	II	(2)/2 (1)/1 G	An assembly, such as a gas detection system with more than one detection head, that is partly category 1 and partly category 2 formed by a safety device and an equipment. The safety device is intended for use outside the hazardous area and the equipment is intended for use inside hazardous area
	II	2(1) G	Category 2 equipment containing a safety device for a category 1 equipment
	II	2(1) GD	Same equipment for gas or dust potentially explosive atmospheres
	II	(2) G (1) G	A safety device alone which ensures the safety against explosion for category 1 equipment and for another category 2 equipment
	II	3/3 D	A blower exhausting out of zone 22 and to be installed in zone 22

Table 7: examples for marking of equipment having different categories

	II	1/2 G	Level gauge installed in the tank wall between zone 0 and zone 1
	II	(2) 3 G	An electrical field bus device affecting category 2 equipment installed in zone 2
	II	2/- G	A ventilator exhausting out of zone 1 but to be installed outside potentially explosive atmospheres. The Directive has no provisions for marking in case of installation outside potentially explosive atmospheres
	II	2/3 G	A ventilator extracting out of zone 1 but to be installed in zone 2
	II	3/- D	A screw conveyor conveying dust out of a zone 22 but installed outside potentially explosive atmospheres. The Directive has no provisions for marking in case of installation outside potentially explosive atmospheres
	II	-/2 D	Blower conveying no explosive atmosphere but to be installed in zone 21

Note: In the above examples, where a zone is indicated, the "normal" correspondence between zone and category is assumed according to the ATEX "workplace" [Directive 1999/92/EC](#), i.e.

- category 1 - zone 0 or 20
- category 2 - zone 1 or 21
- category 3 - zone 2 or 22

All products must be marked with the registered name (or registered trade mark) and address of the manufacturer, designation of series or type, serial number (if any) and

the year of construction. The year of construction and serial number may be combined or in a conventional coded format, in which case the explanation of the code shall be given in the instructions accompanying the product.

Where more than one category is given in the marking, the product must be accompanied with written information explaining the different categories, where they apply, and the consequences for the intended use.

Where a product is covered by more than one "New Approach" / [New Legislative Framework](#) legal act (Union Regulation or Directive), CE marking denotes compliance with the appropriate provisions of all relevant directives. However, where one or more of these directives are in their transitional period and, as a consequence, allow the manufacturer to choose which arrangements to apply, the CE marking indicates conformity only to those directives where application is mandatory and others which are so applied. In the case of these latter directives particulars must be given in the documents, notices or instructions accompanying the product or, where appropriate, on the data plate.

§ 147 Additional marking for standards

Because of the special importance for the safety of products intended for use in potentially explosive atmospheres and in order to avoid any misunderstandings, Directive 2014/34/EU provides for additional markings (see Annex II 1.0.5.).

Equipment, protective systems and components must furthermore be marked with all necessary information essential to the safe use. According to this requirement European standards for electrical and non-electrical products for potentially explosive atmospheres foresee a supplementary marking. For detailed and complete information about this marking it is necessary to use these standards.

It is a requirement that the standard marking should not be used in a way that can allow it to be confused with the mandatory marking. Therefore, it is recommended in the standards that the legal marking of the directive and the additional marking required by the standards remain separate in order to avoid possible confusion.

Further, the standards often recommend that marking for protection against gas hazards and against dust hazards should be presented separately, to avoid confusion, whereas the directive recommends that a single legal marking, incorporating the letters "GD" be applied.

§ 148 Marking of small products

In accordance with the general guidance given to the CE marking of products, it is considered reasonable to affix all other marking to the packaging and the accompanying documents if it is not possible to affix it to the product because of the product's size or nature. The marking on the product may not be reduced or moved to the packaging purely on aesthetic grounds.

On very small products where a reduction in the marking is unavoidable, the following information is nevertheless required:

- CE marking (not for components),

- Ex marking ("epsilon-x", within "the hexagon"), and
- the name or registered trade mark of the manufacturer.

Where possible, at least a simplified address should also be given, sufficient for mail to reach the company. An internet address is not sufficient but the postal address has to be given. In some countries a unique postal code identifies an address. The use of this postal code is sufficient with the country.

§ 149 Marking of components

The ATEX Directive 2014/34/EU explicitly requires marking in Annex II, clause 1.0.5., only for equipment and protective systems. The question, whether components should nevertheless be marked in order to facilitate the implementation to the Directive, has particular practical relevance in cases

- where it is difficult to recognise the difference between ATEX components and standard components, and
- where a manufacturer who wanted to use a component might have serious problems undertaking his risk assessment, if there is no indication about the category of the component.

Apart from the question of marking, the Directive requires a written attestation of conformity for components (see [section § 46](#)). The latter shall give all the necessary information stating the characteristics. This normally occurs assigning to the component an explosion classification according to relevant harmonised standards, which looks like a marking (e.g. Ex II 1/2 G cb Tx or Ex II 1 G c Tx).

For components having an own potential ignition source or which are clearly correlated (with respect to the properties of the component) to equipment with a given category, it has been considered that without the definition of group and category, the necessary conformity procedure of the equipment, which the component will be incorporated to, cannot be performed.

In some cases the conformity procedure can only be performed, if the equipment, which the component will be incorporated to, is defined, and if this incorporation is a matter of the conformity procedure.

Therefore, it is recommended to mark components, as long as these can be assessed with respect to a certain category and group of equipment, indicating this category and group in the marking.

It should be noted that, in most cases, a component will not be marked with a temperature class as it is not, itself, a source of heat, or the temperature can only be determined when fitted within the final equipment.

Moreover, it is recommended to mark components for autonomous protective systems, which can be assessed with respect to the characteristic properties of the latter, as far as reasonable indicating these characteristics in the marking.

In any case, according to Directive 2014/34/EU, ATEX components shall not bear the CE-marking; components can be Ex-marked with the specific marking of explosion protection, as a conformity marking as well as an identification marking.

Marking of components with the notified body's number

It has been discussed whether components subject to NB assessment required by the Directive should be marked with the notified body's identification number.

According to Article 1(1) the ATEX Directive 2014/34/EU applies to equipment, protective systems, safety devices and protective devices, and to components, under the generic denomination of "products". Hence, the provisions of the Directive which apply to "products" apply also to components unless otherwise specified.

The wording of Article 13(3) confirms that it is the intention of the legislator to treat components as products in general, but for those specific cases where explicit exceptions were defined. This is exclusively true for the CE marking (not allowed), and the name of the document by which the conformity is declared (attestation of conformity instead of EU declaration of conformity).

The requirement concerning the marking with the notified body's identification number is addressed in Article 16(3) of the Directive, providing that, where the body is involved in the production control phase, the identification number of the notified body must be affixed following the CE marking. It is clear from the wording of the referred article that CE marking and the marking with the notified body's identification number are two separate requirements.

It is therefore evident that:

- the notified body's identification number shall be placed on components, e.g. when required by the conformity assessment procedures required in Annexes VI or IX;
- although the CE marking requirement does not apply to components due to the specific provisions of Article 13(3), in the absence of an explicit provision to the contrary, Article 38(1)(d) shall be applied also to components;
- Member States shall act on the basis of Article 38(1)(d) against non-compliant components in the same way as against non-compliant equipment or protective systems;
- whenever notified bodies are involved in the production control phase of components, the notified body's identification number should also be placed on that component as required in Article 16(3), but certainly without the CE marking.

§ 150 Marking of combined products (assemblies)

The marking of combined products (assemblies) is identical to the marking of equipment, in particular equipment having different categories. An assembly may consist of a large number of assessed and compliant items (equipment, protective systems, safety devices) with their own specific marking, potentially of different categories. In such cases it would not be helpful to show all of these the individual markings in the marking of the complete assembly. Nevertheless, the marking of the assembly has to display all relevant information required by Annex II, 1.0.5, of Directive 2014/34/EU necessary for the intended use of the assembly as a whole. The marking shall be placed in such a way – e.g. on the outer housing of the assembly – so that there is no doubt that it shows the characteristics of the whole assembly and not just one part.

Assemblies may consist of parts of different categories and be intended for potentially explosive atmospheres having different physical characteristics. The marking of the assembly as a whole with group, categories and additional information essential for the safe use of the assembly (temperature class, etc.) may fall under one of the two following scenarios:

Case 1: The assembly as a whole is intended for use in one potentially explosive atmosphere of one specific zone

Where the individual parts of the assembly are marked for potentially explosive atmospheres having different characteristics, the part with the lowest level of safety defines the marking of the whole assembly. That means that the category, temperature class, explosion group etc. with the lowest requirement for the equipment has to be used for the marking of the whole assembly.

Case 2: Parts of the assembly are intended for use in potentially explosive atmospheres having different physical characteristics and/or different zones

If it is essential for that intended use, the marking of the assembly shall contain all groups, categories and additional markings (temperature class, etc.) necessary for the intended atmospheres. In this case, the instructions for use, installation etc. will indicate the different atmospheres/zones intended (and/or provided by constructional measures) in or around different parts of the equipment.

Examples (only categories and additional markings essential for safe use are given in these examples):

For case 1:

- An assembly consisting of parts marked with T3 and other parts with T6 shall be marked T3 to indicate, that it is, as a whole, intended for use in T3 atmospheres.
- A pump unit consisting of a liquid pump (non-flammable liquid) and driving electric motor. The pump is marked II 2 G T6, the motor II 2 G IIB T4. The whole assembly shall be marked II 2 G IIB T4, as the motor is the part that meets the lower requirements.
- A similar pump unit with a pump conveying hot liquid (non-flammable). The pump is marked II 2 G T3, the motor II 2 G IIB T4. In this case the assembly shall be marked II 2 G IIB T3.

For case 2:

- A fan conveying an occasional IIA T3 explosive atmosphere (zone 1) in normal operation, the fan fitted with an electric motor and some control devices placed in a zone 2, the fan accordingly marked II 2/3 G IIA T3. The motor is marked II 3 G T3, the intrinsically safe control device II 2 G IIC T6. As the intrinsically safe control device is placed in the same atmosphere as the motor, the part meeting the lower requirements (in this case the motor) is the decisive item. Accordingly the marking of the whole assembly is II 2/3 G IIA T3.
- A similar fan assembly, but with the motor placed outside the hazardous area. The marking of the whole assembly is II 2/3- G IIA T3.

1.0.6. Instructions

(a) All equipment and protective systems must be accompanied by instructions, including at least the following particulars:

- a recapitulation of the information with which the equipment or protective system is marked, except for the batch or serial number (see point 1.0.5), together with any appropriate additional information to facilitate maintenance (e.g. address of the repairer, etc.);
- instructions for safe:
 - putting into service,
 - use,
 - assembling and dismantling,
 - maintenance (servicing and emergency repair),
 - installation,
 - adjustment;
- where necessary, an indication of the danger areas in front of pressure-relief devices;
- where necessary, training instructions;
- details which allow a decision to be taken beyond any doubt as to whether an item of equipment in a specific category or a protective system can be used safely in the intended area under the expected operating conditions;
- electrical and pressure parameters, maximum surface temperatures and other limit values;
- where necessary, special conditions of use, including particulars of possible misuse which experience has shown might occur;
- where necessary, the essential characteristics of tools which may be fitted to the equipment or protective system.

(b) The instructions must contain the drawings and diagrams necessary for the putting into service, maintenance, inspection, checking of correct operation and, where appropriate, repair of the equipment or protective system, together with all useful instructions, in particular with regard to safety.

(c) Literature describing the equipment or protective system must not contradict the instructions with regard to safety aspects.

§ 151 Instructions

The ATEX Directive 2014/34/EU prescribes that equipment and protective systems must be accompanied by instructions, covering a wide range of contents. The

manufacturer shall provide to the user written instructions that include the necessary information for safe use, repair, maintenance and/or overhaul of the equipment concerned, etc. The manufacturer does not have to provide the full technical file.

EHSR 1.0.6 does not specify the form of the instructions. It is generally agreed that all health and safety related instructions must be supplied in paper form, since it cannot be assumed that the user has access to the means of reading instructions supplied in electronic form or made available on an Internet site. This is particularly relevant for instructions that might need to be read whilst the plant is operational, in the presence of a potentially explosive atmosphere. However, it is often useful for the instructions to be made available in electronic form and on the Internet as well as in paper form, since this enables the user to download the electronic file if he so wishes and to recover the instructions if the paper copy has been lost. This practice also facilitates the updating of the instructions when this is necessary.

The user takes into account the instructions issued by the manufacturer to carry out repair, maintenance and/or overhaul on the basis of the requirements of the applicable EU Directives (such as [2009/104/EC](#) - *Use of work equipment by workers at work* and [1999/92/EC](#) - *Protection of workers potentially at risk from explosive atmospheres*) and of relevant specific national legislation that regulates the repair, maintenance and overhaul of used equipment. The instructions must contain drawings and diagrams necessary for repair of the equipment. Applicable and technically accepted standards can also be used, for example *EN 60079-19 Explosive atmospheres - Equipment repair, overhaul and reclamation*, which provides for identifying equipment that has been repaired to the manufacturer's information separately from equipment that has been repaired "to standard", i.e. the repairer's "best guess" fit using the certification standard applicable to the equipment, but without access to the manufacturer's instructions.

However, where necessary, the manufacturer can include in his documentation a statement that specific repair, maintenance and/or overhaul of the equipment shall only be conducted by the manufacturer himself, or by a repairer he has qualified or authorized.

With respect to assemblies, it is important to the safe installation, operation and maintenance of the assembled unit that all relevant information is passed to the end user. The manufacturer of the assembled unit should do this by including all related information in a package supplied to the end user.

With respect to instructions for components, see section [§ 46](#).

1.1. *Selection of materials*

- 1.1.1. The materials used for the construction of equipment and protective systems must not trigger off an explosion, taking into account foreseeable operational stresses.
- 1.1.2. Within the limits of the operating conditions laid down by the manufacturer, it must not be possible for a reaction to take place between the materials used and the constituents of the potentially explosive atmosphere which could impair explosion protection.

- 1.1.3. Materials must be so selected that predictable changes in their characteristics and their compatibility in combination with other materials will not lead to a reduction in the protection afforded; in particular, due account must be taken of the material's corrosion and wear resistance, electrical conductivity, mechanical strength, ageing resistance and the effects of temperature variations.

§ 152 Selection of materials

Guidance on selection of materials for the construction of ATEX equipment and protective systems is usually given in European harmonised standards, for example in relation to:

- avoidance of electrostatic ignition risks
 - thermite reactions with aluminium, magnesium, titanium and zirconium
 - light resistance
 - thermal degradation resistance
 - avoiding the use of copper in conjunction with acetylene
- etc.

1.2. Design and construction

- 1.2.1. Equipment and protective systems must be designed and constructed with due regard to technological knowledge of explosion protection so that they can be safely operated throughout their foreseeable lifetime.
- 1.2.2. Components to be incorporated into or used as replacements in equipment and protective systems must be so designed and constructed that they function safely for their intended purpose of explosion protection when they are installed in accordance with the manufacturer's instructions.

§ 153 Design and construction

The current state of technological knowledge is presumed to be given by using the relevant European harmonised standards.

1.2.3. Enclosed structures and prevention of leaks

Equipment which may release flammable gases or dusts must wherever possible employ enclosed structures only.

If equipment contains openings or non-tight joints, these must as far as possible be designed in such a way that releases of gases or dusts cannot give rise to explosive atmospheres outside the equipment.

Points where materials are introduced or drawn off must, as far as possible, be designed and equipped so as to limit releases of flammable materials during filling or draining.

§ 154 Enclosed structures and prevention of leaks

Although prevention of leaks is ideal, there are certain situations, for example in relation to the gassing of a battery during charging, where it is safer to securely vent the produced hazard rather than contain it.

1.2.4. Dust deposits

Equipment and protective systems which are intended to be used in areas exposed to dust must be so designed that deposit dust on their surfaces is not ignited.

In general, dust deposits must be limited where possible. Equipment and protective systems must be easily cleanable.

The surface temperatures of equipment parts must be kept well below the glow temperature of the deposit dust.

The thickness of deposit dust must be taken into consideration and, if appropriate, means must be taken to limit the temperature in order to prevent a heat build up.

§ 155 Dust deposits

The relevant European harmonised standards providing protection against igniting an explosive dust atmosphere also address the relevant issues related to the ignition of dust layers.

1.2.5. Additional means of protection

Equipment and protective systems which may be exposed to certain types of external stresses must be equipped, where necessary, with additional means of protection.

Equipment must withstand relevant stresses, without adverse effect on explosion protection.

§ 156 Additional means of protection

Additional means of protection for ATEX products are required in case of exposure to "certain types of external stresses", in principle distinct (and more severe) from general external stresses, according to the foreseeable conditions of use and operation. In any case, ATEX equipment must be able to resist against relevant stresses with no adverse effects on the required explosion protection.

1.2.6. Safe opening

If equipment and protective systems are in a housing or a locked container forming part of the explosion protection itself, it must be possible to open such housing or container only with a special tool or by means of appropriate protection measures.

§ 157 Safe opening

Relevant European harmonised standards give guidance on the use of fasteners and the tools that may be used to open them, as well as the use of interlocks as an alternative.

Even though there is now only "special fastenings", the three historic levels of "safe opening" are not precluded by this essential health and safety requirement 1.2.6 and it is not the intention of Directive 2014/34/EU to require a level of safety higher than that required by the EN 60079 series of standards for the equivalent zone of risk.

Level 1, the use of "Special Tools" e.g. on fasteners with hexagonal socket heads can still be used as specifically described by EHSR 1.2.6.

Level 2, the use of fasteners which require some form of tool to open the door e.g. a simple screwdriver, an adjustable spanner, or a key, are allowed in EHSR 1.2.6 where the additional "appropriate protection measure" would be the presence of a warning label requiring the operator to "De-energise before opening" or similar text.

Note: To qualify for Level 2 a "key" operated fastener (if used) should be used in conjunction with a lock mechanism that automatically locks the door in the closed position when the door is closed. The use of a lock which requires the use of a key to lock it in the closed position is not allowed for Level 2 since the operator may choose not to lock the door again when the door is closed and the additional protection required is no longer provided.

Level 3, the use of a door fastener which would allow the operator to open the door of the enclosure without the use of any tool i.e. with the "bare hands", is also not prevented by EHSR 1.2.6. However because of the increased personal and explosion risk additional measures have to be applied e.g. the use of an electrical or mechanical interlock to de-energise automatically the interior of the enclosure as well as the conspicuous presence of the warning label used in Level 2 above.

1.2.7. Protection against other hazards

Equipment and protective systems must be so designed and manufactured as to:

- (a) avoid physical injury or other harm which might be caused by direct or indirect contact;
- (b) assure that surface temperatures of accessible parts or radiation which would cause a danger, are not produced;
- (c) eliminate non-electrical dangers which are revealed by experience;
- (d) assure that foreseeable conditions of overload do not give rise to dangerous situations.

Where, for equipment and protective systems, the risks referred to in this point are wholly or partly covered by other Union legislation, this Directive shall not apply or

shall cease to apply in the case of such equipment and protective systems and of such risks upon application of that specific Union legislation.

§ 158 Protection against other hazards

Among other hazards, those related to the Low Voltage [Directive 2014/35/EU](#) (LVD) are particularly relevant.

For the relationships between the ATEX Directive 2014/34/EU and other Union legislation, see sections [§§ 231-240](#).

1.2.8. Overloading of equipment

Dangerous overloading of equipment must be prevented at the design stage by means of integrated measurement, regulation and control devices, such as over-current cut-off switches, temperature limiters, differential pressure switches, flowmeters, time-lag relays, overspeed monitors and/or similar types of monitoring devices.

§ 159 Overloading of equipment

Relevant European harmonised standards provide advice in many cases, but cannot cover all possibilities.

1.2.9. Flameproof enclosure systems

If parts which can ignite an explosive atmosphere are placed in an enclosure, measures must be taken to ensure that the enclosure withstands the pressure developed during an internal explosion of an explosive mixture and prevents the transmission of the explosion to the explosive atmosphere surrounding the enclosure.

§ 160 Flameproof enclosure systems

There is a specific European harmonised standard applicable to flameproof enclosure systems: EN 60079-1 *Explosive atmospheres - Part 1: Equipment protection by flameproof enclosures 'd'*.

1.3. Potential ignition sources

§ 161 Potential ignition sources

Paragraph 1.3 details the potential ignition sources that must be considered for ATEX equipment, according to its definition in Article 2(1).

1.3.1. Hazards arising from different ignition sources

Potential ignition sources such as sparks, flames, electric arcs, high surface temperatures, acoustic energy, optical radiation, electromagnetic waves and other ignition sources must not occur.

§ 162 Hazards arising from different ignition sources

These ignition sources are considered in outline in the European harmonised standard EN 1127-1 *Explosive atmospheres - Explosion prevention and protection - Part 1: Basic concepts and methodology*. For equipment intended for use in underground parts of mines, further information can be found in the European harmonised standard EN 1127-2 *Explosive atmospheres - Explosion prevention and protection - Part 2: Basic concepts and methodology for mining*.

1.3.2. Hazards arising from static electricity

Electrostatic charges capable of resulting in dangerous discharges must be prevented by means of appropriate measures.

§ 163 Hazards arising from static electricity

Electrostatic discharge, as a source of ignition, is often within the control of the design of the installation, rather than the equipment, and comes within the scope of the ATEX "workplace" [Directive 1999/92/EC](#), backed up by standards providing appropriate detailed information.

However, the design of equipment can help to mitigate such risks and appropriate requirements are detailed in European harmonised standards.

Where equipment is otherwise outside the scope of Directive 2014/34/EU, the potential for a static discharge in use does not bring it into scope.

1.3.3. Hazards arising from stray electric and leakage currents

Stray electric and leakage currents in conductive equipment parts which could result in, for example, the occurrence of dangerous corrosion, overheating of surfaces or sparks capable of provoking an ignition must be prevented.

§ 164 Hazards arising from stray electric and leakage currents

Stray electric currents may flow, for example, in the external frame and enclosure of a large electric motor, as a result of magnetic fluxes not being confined to the magnetic core of the stator and rotor. Such currents can become an ignition source under certain circumstances. Detailed requirements are provided in relevant European harmonised standards.

Other examples of stray electric currents would include those from galvanic corrosion protection circuits.

1.3.4. Hazards arising from overheating

Overheating caused by friction or impacts occurring, for example, between materials and parts in contact with each other while rotating or through the intrusion of foreign bodies must, as far as possible, be prevented at the design stage.

§ 165 Hazards arising from overheating

Relevant European harmonised standards provide guidance on this kind of hazards.

1.3.5. Hazards arising from pressure compensation operations

Equipment and protective systems must be so designed or fitted with integrated measuring, control and regulation devices that pressure compensations arising from them do not generate shock waves or compressions which may cause ignition.

§ 166 Hazards arising from pressure compensation operations

This essential health and safety requirement aims to prevent ATEX products to cause adverse effects such as ignition when carrying out pressure compensation operations.

1.4. *Hazards arising from external effects*

1.4.1. Equipment and protective systems must be so designed and constructed as to be capable of performing their intended function in full safety, even in changing environmental conditions and in the presence of extraneous voltages, humidity, vibrations, contamination and other external effects, taking into account the limits of the operating conditions established by the manufacturer.

1.4.2. Equipment parts used must be appropriate to the intended mechanical and thermal stresses and capable of withstanding attack by existing or foreseeable aggressive substances.

§ 167 Hazards arising from external effects

The manufacturer's instruction document should clearly define which potential external effects have been taken into account.

1.5. *Requirements in respect of safety-related devices*

1.5.1. Safety devices must function independently of any measurement and/or control devices required for operation.

As far as possible, failure of a safety device must be detected sufficiently rapidly by appropriate technical means to ensure that there is only very little likelihood that dangerous situations will occur.

The fail-safe principle is to be applied in general.

Safety-related switching must in general directly actuate the relevant control devices without intermediate software command.

1.5.2. In the event of a safety device failure, equipment and/or protective systems shall, wherever possible, be secured.

1.5.3. Emergency stop controls of safety devices must, as far as possible, be fitted with restart lockouts. A new start command may take effect on normal operation only after the restart lockouts have been intentionally reset.

§ 168 Requirements in respect of safety-related devices

It should be noted that the text of clause 1.5 was written before standards in the EN 61508 series (and its derivatives) were written, which expand considerably on the "fail-safe principle". European harmonised standard EN 50495 interprets the EN 61508 requirements in the context of clause 1.5 of the EHSRs of 2014/34/EU.

ATEX safety devices and control devices for non-ATEX related functions shall operate independently from each other. Therefore, the control device and safety device cannot be integrated in one single device, but may be mounted in a common enclosure.

The Directive defines a specific number of faults (according to Category – see [section § 176](#)) that have to be taken into account when evaluating protection systems. The "fail safe principle" means that the safety systems should function reliably even in the case of these faults and the equipment and/or protective systems should be secured to reduce the ignition risk to the required level.

See also [section § 36](#) on safety devices, controlling devices and regulating devices as defined in Article 1(1)(b).

1.5.4. Control and display units

Where control and display units are used, they must be designed in accordance with ergonomic principles in order to achieve the highest possible level of operating safety with regard to the risk of explosion.

§ 169 Control and display units

In general terms, ergonomic principles are regarded as part of safety integration, or "safety by design", for equipment to be operated by users in specific working conditions. An example of an advanced application of ergonomic principles within safety integration can be found in the Machinery Directive, Annex I, 1.1.6.

The ATEX Directive 2014/34/EU makes an explicit reference to ergonomic design in this essential health and safety requirement 1.5.4. for control and display units. They must take into account these aspects in order to ensure safe operation of the related equipment.

1.5.5. Requirements in respect of devices with a measuring function for explosion protection

In so far as they relate to equipment used in explosive atmospheres, devices with a measuring function must be designed and constructed so that they can cope with foreseeable operating requirements and special conditions of use.

1.5.6. Where necessary, it must be possible to check the reading accuracy and serviceability of devices with a measuring function.

1.5.7. The design of devices with a measuring function must incorporate a safety factor which ensures that the alarm threshold lies far enough outside the explosion and/or ignition limits of the atmospheres to be registered, taking into account, in particular, the operating conditions of the installation and possible aberrations in the measuring system.

§ 170 Requirements in respect of devices with a measuring function for explosion protection

It is implicit in the wording of these clauses that the measuring device relates to measuring relevant parameters e.g. the concentration of gas, surface temperature, filling levels, etc. There is a series of European harmonised standards which provide guidance on the performance of gas detection equipment and safety devices.

1.5.8. Risks arising from software

In the design of software-controlled equipment, protective systems and safety devices, special account must be taken of the risks arising from faults in the programme.

§ 171 Risks arising from software

Reference should be made to the various implementations of EN 61508-3 *Functional safety of electrical/electronic/programmable electronic safety-related systems - Part 3: Software requirements* which specifically deals with software applications in programmable safety related systems. European harmonised standard EN 50495 *Safety devices required for the safe functioning of equipment with respect to explosion risks* refers directly to EN 61508-3 for software consideration.

1.6. Integration of safety requirements relating to the system

1.6.1. Manual override must be possible in order to shut down the equipment and protective systems incorporated within automatic processes which deviate from the intended operating conditions, provided that this does not compromise safety.

1.6.2. When the emergency shutdown system is actuated, accumulated energy must be dispersed as quickly and as safely as possible or isolated so that it no longer constitutes a hazard.

This does not apply to electrochemically-stored energy.

§ 172 Integration of safety requirements relating to the system

Consideration must be given to arrangements for a controlled shut-down of a system, should that be necessary to avoid creating additional hazards.

1.6.3. Hazards arising from power failure

Where equipment and protective systems can give rise to a spread of additional risks in the event of a power failure, it must be possible to maintain them in a safe state of operation independently of the rest of the installation.

§ 173 Hazards arising from power failure

For some safety related systems, it will be necessary to provide stand-by power to ensure that the process can be safely shut down in the event of a general power failure.

Additional points for consideration could include the performance of an induction generator if it became detached from a stable grid supply and its voltage rose uncontrollably.

1.6.4. Hazards arising from connections

Equipment and protective systems must be fitted with suitable cable and conduit entries.

When equipment and protective systems are intended for use in combination with other equipment and protective systems, the interface must be safe.

§ 174 Hazards arising from connections

The aim of this essential health and safety requirement is prevention of adverse effects from failure in connections (cables, conduit entries...) which can give rise to additional risks.

1.6.5. Placing of warning devices as parts of equipment

Where equipment or protective systems are fitted with detection or alarm devices for monitoring the occurrence of explosive atmospheres, the necessary instructions must be provided to enable them to be provided at the appropriate places.

§ 175 Placing of warning devices as parts of equipment

Adequate availability of instructions is very much related to safe operations of equipment; in this case, concerning warning devices detecting an explosive atmosphere.

See also section [§151](#) on instructions.

2. Supplementary requirements in respect of equipment

2.0. Requirements applicable to equipment in equipment-group I

2.0.1. Requirements applicable to equipment category M1 of equipment-group I

2.0.1.1. Equipment must be so designed and constructed that sources of ignition do not become active, even in the event of rare incidents relating to equipment.

Equipment must be equipped with means of protection such that:

- either, in the event of failure of one means of protection, at least an independent second means provides the requisite level of protection,
- or, the requisite level of protection is ensured in the event of two faults occurring independently of each other.

Where necessary, equipment must be equipped with additional special means of protection.

It must remain functional with an explosive atmosphere present.

2.0.1.2. Where necessary, equipment must be so constructed that no dust can penetrate it.

2.0.1.3. The surface temperatures of equipment parts must be kept clearly below the ignition temperature of the foreseeable air/dust mixtures in order to prevent the ignition of suspended dust.

2.0.1.4. Equipment must be so designed that the opening of equipment parts which may be sources of ignition is possible only under non-active or intrinsically safe conditions. Where it is not possible to render equipment non-active, the manufacturer must affix a warning label to the opening part of the equipment.

If necessary, equipment must be fitted with appropriate additional interlocking systems.

2.0.2. Requirements applicable to equipment category M 2 of equipment-group I

2.0.2.1. Equipment must be equipped with means of protection ensuring that sources of ignition do not become active during normal operation, even under more severe operating conditions, in particular those arising from rough handling and changing environmental conditions.

The equipment is intended to be de-energized in the event of an explosive atmosphere.

2.0.2.2. Equipment must be so designed that the opening of equipment parts which may be sources of ignition is possible only under non-active conditions or via appropriate interlocking systems. Where it is not possible to render equipment non-active, the manufacturer must affix a warning label to the opening part of the equipment.

2.0.2.3. The requirements regarding explosion hazards arising from dust applicable to equipment category M 1 must be applied.

2.1. *Requirements applicable to equipment category I of equipment-group II*

2.1.1. Explosive atmospheres caused by gases, vapours or mists

2.1.1.1. Equipment must be so designed and constructed that sources of ignition do not become active, even in event of rare incidents relating to equipment.

It must be equipped with means of protection such that:

- either, in the event of failure of one means of protection, at least an independent second means provides the requisite level of protection,
- or, the requisite level of protection is ensured in the event of two faults occurring independently of each other.

2.1.1.2. For equipment with surfaces which may heat up, measures must be taken to ensure that the stated maximum surface temperatures are not exceeded even in the most unfavourable circumstances.

Temperature rises caused by heat build-ups and chemical reactions must also be taken into account.

2.1.1.3. Equipment must be so designed that the opening of equipment parts which might be sources of ignition is possible only under non-active or intrinsically safe conditions. Where it is not possible to render equipment non-active, the manufacturer must affix a warning label to the opening part of the equipment.

If necessary, equipment must be fitted with appropriate additional interlocking systems.

2.1.2. Explosive atmospheres caused by air/dust mixtures

2.1.2.1. Equipment must be so designed and constructed that ignition of air/dust mixtures does not occur even in the event of rare incidents relating to equipment.

It must be equipped with means of protection such that

- either, in the event of failure of one means of protection, at least an independent second means provides the requisite level of protection,
- or, the requisite level of protection is ensured in the event of two faults occurring independently of each other.

2.1.2.2. Where necessary, equipment must be so designed that dust can enter or escape from the equipment only at specifically designated points.

This requirement must also be met by cable entries and connecting pieces.

2.1.2.3. The surface temperatures of equipment parts must be kept well below the ignition temperature of the foreseeable air/dust mixtures in order to prevent the ignition of suspended dust.

2.1.2.4. With regard to the safe opening of equipment parts, requirement 2.1.1.3 applies.

2.2. *Requirements applicable to equipment category 2 of equipment-group II*

2.2.1. Explosive atmospheres caused by gases, vapours or mists

2.2.1.1. Equipment must be so designed and constructed as to prevent ignition sources arising, even in the event of frequently occurring disturbances or equipment operating faults, which normally have to be taken into account.

2.2.1.2. Equipment parts must be so designed and constructed that their stated surface temperatures are not exceeded, even in the case of risks arising from abnormal situations anticipated by the manufacturer.

2.2.1.3. Equipment must be so designed that the opening of equipment parts which might be sources of ignition is possible only under non-active conditions or via appropriate interlocking systems. Where it is not possible to render equipment non-active, the manufacturer must affix a warning label to the opening part of the equipment.

2.2.2. Explosive atmospheres caused by air/dust mixtures

2.2.2.1. Equipment must be designed and constructed so that ignition of air/dust mixtures is prevented, even in the event of frequently occurring disturbances or equipment operating faults which normally have to be taken into account.

2.2.2.2. With regard to surface temperatures, requirement 2.1.2.3 applies.

2.2.2.3. With regard to protection against dust, requirement 2.1.2.2 applies.

2.2.2.4. With regard to the safe opening of equipment parts, requirement 2.2.1.3 applies.

2.3. *Requirements applicable to equipment category 3 of equipment-group II*

2.3.1. Explosive atmospheres caused by gases, vapours or mists

- 2.3.1.1. Equipment must be so designed and constructed as to prevent foreseeable ignition sources which can occur during normal operation.
- 2.3.1.2. Surface temperatures must not exceed the stated maximum surface temperatures under intended operating conditions. Higher temperatures in exceptional circumstances may be allowed only if the manufacturer adopts special additional protective measures.
- 2.3.2. Explosive atmospheres caused by air/dust mixtures
 - 2.3.2.1. Equipment must be so designed and constructed that air/dust mixtures cannot be ignited by foreseeable ignition sources likely to exist during normal operation.
 - 2.3.2.2. With regard to surface temperatures, requirement 2.1.2.3 applies.
 - 2.3.2.3. Equipment, including cable entries and connecting pieces, must be so constructed that, taking into account the size of its particles, dust can neither develop explosive mixtures with air nor form dangerous accumulations inside the equipment.

§ 176 Supplementary requirements in respect of equipment

Section 2 of Annex II to Directive 2014/34/EU includes a list of supplementary requirements for ATEX equipment, according to equipment-groups and categories and taking into consideration different kinds of potentially explosive atmospheres caused by gases, vapours or mists, as well as possible ignition sources.

Specific guidance on technical solutions to be used to comply with these requirements for ATEX equipment is provided in the relevant European harmonised standards.

3. Supplementary requirements in respect of protective systems

3.0. General requirements

- 3.0.1. Protective systems must be dimensioned in such a way as to reduce the effects of an explosion to a sufficient level of safety.
- 3.0.2. Protective systems must be designed and capable of being positioned in such a way that explosions are prevented from spreading through dangerous chain reactions or flashover and incipient explosions do not become detonations.
- 3.0.3. In the event of a power failure, protective systems must retain their capacity to function for a period sufficient to avoid a dangerous situation.
- 3.0.4. Protective systems must not fail due to outside interference.

3.1. Planning and design

- 3.1.1. Characteristics of materials

With regard to the characteristics of materials, the maximum pressure and temperature to be taken into consideration at the planning stage are the expected pressure during an explosion occurring under extreme operating conditions and the anticipated heating effect of the flame.

3.1.2. Protective systems designed to resist or contain explosions must be capable of withstanding the shock wave produced without losing system integrity.

3.1.3. Accessories connected to protective systems must be capable of withstanding the expected maximum explosion pressure without losing their capacity to function.

3.1.4. The reactions caused by pressure in peripheral equipment and connected pipe-work must be taken into consideration in the planning and design of protective systems.

3.1.5. Pressure-relief systems

If it is likely that stresses on protective systems will exceed their structural strength, provision must be made in the design for suitable pressure-relief devices which do not endanger persons in the vicinity.

3.1.6. Explosion suppression systems

Explosion suppression systems must be so planned and designed that they react to an incipient explosion at the earliest possible stage in the event of an incident and counteract it to best effect, with due regard to the maximum rate of pressure increase and the maximum explosion pressure.

3.1.7. Explosion decoupling systems

Decoupling systems intended to disconnect specific equipment as swiftly as possible in the event of incipient explosions by means of appropriate devices must be planned and designed so as to remain proof against the transmission of internal ignition and to retain their mechanical strength under operating conditions.

3.1.8. Protective systems must be capable of being integrated into a circuit with a suitable alarm threshold so that, if necessary, there is cessation of product feed and output and shutdown of equipment parts which can no longer function safely.

§ 177 Supplementary requirements in respect of protective systems

On definition and description of ATEX protective systems, see section [§ 45](#).

Section 3 of Annex II to Directive 2014/34/EU includes a list of supplementary requirements for ATEX protective systems.

Specific guidance on technical solutions to be used to comply with these requirements for ATEX protective systems is provided in the relevant European harmonised standards.

MODULE B: EU-TYPE EXAMINATION

1. EU-type examination is the part of a conformity assessment procedure in which a notified body examines the technical design of a product and verifies and attests that the technical design of the product meets the requirements of this Directive that apply to it.
2. EU-type examination shall be carried out with the examination of a specimen, representative of the production envisaged, of the complete product (production type).

§ 178 EU-type examination

EU-type examination provides a specimen of the envisaged production to a notified body which undertakes the necessary evaluation to determine that the "type" meets the essential requirements of Directive 2014/34/EU and issues an EU-type examination certificate. As an additional result of EU-type examination a list of schedule documentation is precise.

EU-type examination is always followed by other modules by which the conformity of the products to the approved EU-type is demonstrated (*see also section § 89 on conformity assessment procedures and Table 3*).

3. The manufacturer shall lodge an application for EU-type examination with a single notified body of his choice.

The application shall include:

- (a) the name and address of the manufacturer and, if the application is lodged by the authorised representative, his name and address as well,
- (b) a written declaration that the same application has not been lodged with any other notified body,
- (c) the technical documentation. The technical documentation shall make it possible to assess the product's conformity with the applicable requirements of this Directive and shall include an adequate analysis and assessment of the risk(s). The technical documentation shall specify the applicable requirements and cover, as far as relevant for the assessment, the design, manufacture and operation of the product. The technical documentation shall contain at least the following elements:
 - (i) a general description of the product,
 - (ii) conceptual design and manufacturing drawings and schemes of components, sub-assemblies, circuits, etc.,
 - (iii) descriptions and explanations necessary for the understanding of those drawings and schemes and the operation of the product,

(iv) a list of the harmonised standards applied in full or in part the references of which have been published in the *Official Journal of the European Union* and, where those harmonised standards have not been applied, descriptions of the solutions adopted to meet the essential health and safety requirements of this Directive, including a list of other relevant technical specifications applied. In the event of partly applied harmonised standards, the technical documentation shall specify the parts which have been applied,

(v) results of design calculations made, examinations carried out, etc., and

(vi) test reports,

(d) the specimens representative of the production envisaged. The notified body may request further specimens if needed for carrying out the test programme.

§ 179 The application for EU-type examination

In order to make the application process easier, notified bodies may prepare specific application forms. After a verification of the application and after checking that the submitted documents and testing sample or samples are suitable to carry out the certification process, the concerned notified body issues a written confirmation of receipt of the application from the manufacturer.

The required tests, carried out by the notified body, may need a special preparation of testing sample or samples. It is agreed between applicant and notified body, within their own contractual agreements.

The notified body takes full responsibility on the scope of tests and assessments.

4. The notified body shall:

4.1. examine the technical documentation, verify that the specimen(s) have been manufactured in conformity with the technical documentation, and identify the elements which have been designed in accordance with the applicable provisions of the relevant harmonised standards, as well as the elements which have been designed in accordance with other relevant technical specifications;

4.2. carry out appropriate examinations and tests, or have them carried out, to check whether, where the manufacturer has chosen to apply the solutions in the relevant harmonised standards, these have been applied correctly;

4.3. carry out appropriate examinations and tests, or have them carried out, to check whether, where the solutions in the relevant harmonised standards have not been applied, the solutions adopted by the manufacturer applying other relevant technical specifications meet the corresponding essential health and safety requirements of this Directive;

- 4.4. agree with the manufacturer on a location where the examinations and tests will be carried out.

§ 180 Tasks to be performed by the notified body

The notified body has to carry out the examination of the technical documentation as well as of the sample or samples. In particular:

- carries out appropriate examinations and tests,
- draws up an evaluation report that may be released only upon agreement with the manufacturer,
- issues an EU-type examination certificate,
- informs its notifying authorities and the other bodies about the EU-type examinations it has performed, and
- keeps record of its decisions and other relevant information.

5. The notified body shall draw up an evaluation report that records the activities undertaken in accordance with point 4 and their outcomes. Without prejudice to its obligations vis-à-vis the notifying authorities, the notified body shall release the content of that report, in full or in part, only with the agreement of the manufacturer.

§ 181 The evaluation report

The results of the assessment and tests carried out by the notified body have to be included in an ATEX Assessment Report.

See section [§ 112](#) on the minimum content of a European standardised ATEX test and assessment report.

6. Where the type meets the requirements of this Directive that apply to the product concerned, the notified body shall issue an EU-type examination certificate to the manufacturer. That certificate shall contain the name and address of the manufacturer, the conclusions of the examination, the conditions (if any) for its validity and the necessary data for identification of the approved type. The EU-type examination certificate may have one or more annexes attached.

The EU-type examination certificate and its annexes shall contain all relevant information to allow the conformity of manufactured products with the examined type to be evaluated and to allow for in-service control.

Where the type does not satisfy the applicable requirements of this Directive, the notified body shall refuse to issue an EU-type examination certificate and shall inform the applicant accordingly, giving detailed reasons for its refusal.

§ 182 The EU-type examination certificate

The European ATEX Notified Bodies Group (ExNBG) has established a format for the EU-type examination certificate. The EU-type examination certificate may contain

a special condition of use for equipment or protective system or schedule of limitation for component.

The EU-type examination certificate has to contain all the information necessary for the identification of the product:

- identification number of certificate;
- name and type of product;
- manufacturer's name and address;
- list of harmonized standards used for assessment (if any);
- description of product;
- list of technical parameters significant for Ex safety;
- schedule of limitation or special condition of use.

§ 183 The EU-type examination certificate and the responsibilities of stakeholders

An EU-type examination certificate attests that a specimen (including instructions, as appropriate) representative of the production envisaged by the manufacturer fulfils the relevant applicable provisions of the Directive, in particular the essential health and safety requirements (EHSRs). The question arises as to the actions that need to be taken when the "generally acknowledged state of the art" has developed. It is clear that the original specifications applied may continue to show fulfilment of the EHSRs and the EU-type examination certificate then remains valid.

However, over time the "generally acknowledged state of the art" can develop substantively such that the specifications originally applied no longer ensure the type examined complies with the EHSRs. It should be noted that the question of whether there has been substantive development of the state of the art is not left to discretionary interpretation by the notified body, but has equally to be generally acknowledged by the technical community of the stakeholders. The publication of a revised European harmonised standard would be one way to recognise a development in the state of the art: in this case, the responsible European Standardisation Organisation (ESOs: CEN and CENELEC) shall determine whether the state of the art concerning the EHSRs has changed, and if so, in what respects. The ESO shall indicate this in the foreword of each standard.

In such cases, if the specifications and evaluation criteria originally applied to a product no longer ensure that it complies with the latest state of the art concerning the EHSRs, the EU-type examination certificate is no longer valid and further action is required. Given reasonable transition periods and knowledge of current developments, it is expected that the manufacturer will have sufficient time to contact a notified body to undertake the necessary re-evaluation so that there is a smooth transition from one set of applied specifications to another. Notified bodies, who are expected to maintain a good knowledge of developments in the state of the art, should make arrangements to alert the holders of their EU-type examination certificates to the revision of harmonised standards.

It should be noted, however, that the issuing of a new EU-type examination certificate will have no retroactive effect and, therefore, will not affect products placed on the market and/or put into service whilst the manufacturer was in possession, where appropriate, of a valid certificate.

It should also be re-affirmed that the overall responsibility for compliance of the product rests with the manufacturer who, where required, must ensure that a valid certificate is in his possession, as well as that all relevant conformity documents correspond to the current state of the art. In parallel, the notified body must provide all the relevant information for the manufacturer in order to ensure that the existing certificate is correct in its evaluation that the type continues to meet the EHSRs.

7. The notified body shall keep itself apprised of any changes in the generally acknowledged state of the art which indicate that the approved type may no longer comply with the applicable requirements of this Directive, and shall determine whether such changes require further investigation. If so, the notified body shall inform the manufacturer accordingly.

The manufacturer shall inform the notified body that holds the technical documentation relating to the EU-type examination certificate of all modifications to the approved type that may affect the conformity of the product with the essential health and safety requirements of this Directive or the conditions for validity of that certificate. Such modifications shall require additional approval in the form of an addition to the original EU-type examination certificate.

§ 184 Changes and modifications

Any changes concerning the EU-type examination certificate must be indicated either in a specific supplement to the original certificate or in a revised edition of the original certificate.

Changes may be a result of:

- technical parameters changes;
- name or type changes;
- new version of the product;
- conditions of product use changes;
- harmonised standards changes.

The form of addition to EU-type examination certificate is also established by the European ATEX Notified Bodies Group (ExNBG).

The way how manufacturers inform about these changes should be agreed: by website, mailing, audit, etc.

8. Each notified body shall inform its notifying authority concerning the EU-type examination certificates and/or any additions thereto which it has issued or withdrawn, and shall, periodically or upon request, make available to its notifying authority the list of such certificates and/or any additions thereto refused, suspended or otherwise restricted.

Each notified body shall inform the other notified bodies concerning the EU-type examination certificates and/or any additions thereto which it has refused, withdrawn, suspended or otherwise restricted, and, upon request, concerning such certificates and/or additions thereto which it has issued.

The Commission, the Member States and the other notified bodies may, on request, obtain a copy of the EU-type examination certificates and/or additions thereto. On request, the Commission and the Member States may obtain a copy of the technical documentation and the results of the examinations carried out by the notified body. The notified body shall keep a copy of the EU-type examination certificate, its annexes and additions, as well as the technical file including the documentation submitted by the manufacturer, until the expiry of the validity of that certificate.

§ 185 Obligations for the notified body

Notified bodies are obliged to co-operate and coordinate their activities. In particular, notified bodies have a general obligation to inform the other notified bodies and national market surveillance authorities about all certificates suspended or withdrawn due to safety related nonconformities and, on request, about certificates issued or refused (see also section [§ 115](#)).

Notified bodies must also provide market surveillance authorities with relevant information for the purpose of market surveillance; even if is considered inappropriate for notified bodies to be responsible for market surveillance activities as such.

§ 186 Validity of EU-type examination certificates

Paragraphs 6, 7 and 8 of Annex III to the ATEX Directive 2014/34/EU include some references to the validity of EU-type examination certificates. Such references come from [Decision No 768/2008/EC](#) within the [New Legislative Framework](#).

There is no obligation to establish a period of validity for EU-type examination certificates; in principle, certificates remain valid indefinitely or until their expiry date, where indicated. But there could be several reasons which can influence the validity of an EU-type examination certificate, e.g. a modification of an approved type.

9. The manufacturer shall keep a copy of the EU-type examination certificate, its annexes and additions together with the technical documentation at the disposal of the national authorities for 10 years after the product has been placed on the market.

§ 187 Obligations for the manufacturer

The provision on "10 years after the product has been placed on the market" should be understood as related to the last item of the product model placed on the market.

After such 10 (ten) years period, the manufacturer ceases to be liable, unless legal action is pending. Further, any prejudiced party (the victim of damages) must file an action within three years of the damage, the defect and the identity of the producer being known. No waivers of liability in relation to the injured person may be agreed.

The Directive on product liability⁴³ does not require Member States to repeal any other legislation on liability. In this respect, the Directive's regime adds to the existing national rules on liability. It is up to the victim to choose the grounds on which to file the action.

10. The manufacturer's authorised representative may lodge the application referred to in point 3 and fulfil the obligations set out in points 7 and 9, provided that they are specified in the mandate.

§ 188 Authorised representative

According to the mandate contractually agreed with the manufacturer, the authorised representative can be entitled to lodge the application for the EU-type examination and to fulfil the obligations related to information on modifications, and to retaining a copy of the EU-type examination certificate.

ANNEX IV

MODULE D: CONFORMITY TO TYPE BASED ON QUALITY ASSURANCE OF THE PRODUCTION PROCESS

1. Conformity to type based on quality assurance of the production process is the part of a conformity assessment procedure whereby the manufacturer fulfils the obligations laid down in points 2 and 5, and ensures and declares on his sole responsibility that the products concerned are in conformity with the type described in the EU-type examination certificate and satisfy the requirements of this Directive that apply to them.

§ 189 Conformity to type based on quality assurance of the production process

Module D "Conformity to type based on quality assurance of the production process" as Annex IV to the ATEX Directive 2014/34/EU (indicated as "Production quality assurance" in the previous Directive 94/9/EC) is one of modules that may be applied after the Module B (EU-type examination certificate, Annex III).

This conformity assessment procedure operates a quality system approved by a notified body for production, final equipment inspection and testing, and it is subject to on-going surveillance.

2. Manufacturing

⁴³ Council Directive of 25 July 1985 on the approximation of the laws, regulations and administrative provisions of the Member States concerning liability for defective products (85/374/EEC) (OJ L 210, 7.8.1985, p. 29)

The manufacturer shall operate an approved quality system for production, final product inspection and testing of the products concerned as specified in point 3, and shall be subject to surveillance as specified in point 4.

§ 190 Manufacturing

The manufacturer has to implement and manage an approved quality system for his operations of production, final product inspection and testing of his products, in order to ensure compliance of the manufactured products to the approved EU-type (under module B) and the legislative requirements.

For the general obligations of manufacturers, see section [§ 74](#).

3. Quality system

3.1. The manufacturer shall lodge an application for assessment of his quality system with the notified body of his choice, for the products concerned.

The application shall include:

- (a) the name and address of the manufacturer and, if the application is lodged by the authorised representative, his name and address as well,
- (b) a written declaration that the same application has not been lodged with any other notified body,
- (c) all relevant information for the product category envisaged,
- (d) the documentation concerning the quality system,
- (e) the technical documentation of the approved type and a copy of the EU-type examination certificate.

3.2. The quality system shall ensure that the products are in conformity with the type described in the EU-type examination certificate and comply with the requirements of this Directive that apply to them.

All the elements, requirements and provisions adopted by the manufacturer shall be documented in a systematic and orderly manner in the form of written policies, procedures and instructions. The quality system documentation shall permit a consistent interpretation of the quality programmes, plans, manuals and records.

It shall, in particular, contain an adequate description of:

- (a) the quality objectives and the organisational structure, responsibilities and powers of the management with regard to product quality,
- (b) the corresponding manufacturing, quality control and quality assurance techniques, processes and systematic actions that will be used,

- (c) the examinations and tests that will be carried out before, during and after manufacture, and the frequency with which they will be carried out,
- (d) the quality records, such as inspection reports and test data, calibration data, qualification reports on the personnel concerned, etc., and
- (e) the means of monitoring the achievement of the required product quality and the effective operation of the quality system.

3.3. The notified body shall assess the quality system to determine whether it satisfies the requirements referred to in point 3.2.

It shall presume conformity with those requirements in respect of the elements of the quality system that comply with the corresponding specifications of the relevant harmonised standard.

In addition to experience in quality management systems, the auditing team shall have at least one member with experience of evaluation in the relevant product field and product technology concerned, and knowledge of the applicable requirements of this Directive. The audit shall include an assessment visit to the manufacturer's premises. The auditing team shall review the technical documentation referred to in point 3.1(e) to verify the manufacturer's ability to identify the relevant requirements of this Directive and to carry out the necessary examinations with a view to ensuring compliance of the product with those requirements.

The decision shall be notified to the manufacturer. The notification shall contain the conclusions of the audit and the reasoned assessment decision.

3.4. The manufacturer shall undertake to fulfil the obligations arising out of the quality system as approved and to maintain it so that it remains adequate and efficient.

3.5. The manufacturer shall keep the notified body that has approved the quality system informed of any intended change to the quality system.

The notified body shall evaluate any proposed changes and decide whether the modified quality system will continue to satisfy the requirements referred to in point 3.2 or whether a reassessment is necessary.

It shall notify the manufacturer of its decision. The notification shall contain the conclusions of the examination and the reasoned assessment decision.

§ 191 Quality system

The quality system must include the following elements and has to be documented:

- quality objectives,
- organisational structure,
- manufacturing and quality control techniques,
- tests (carried out before, during and after manufacturing),
- quality records, and
- monitoring methods.

The manufacturer has to fulfil the obligations related to the quality system and must ensure compliance of the manufactured products to the approved EU-type (under module B) and the legislative requirements.

The manufacturer has to submit an application to a notified body to carry out an assessment of his quality system. Application forms prepared by notified bodies can be used.

The notified body performs initial and periodic audits in order to assess and survey the quality system, including:

- review of the technical documentation,
- control of the quality system,
- inspections, and
- product tests.

A quality system implemented on the basis of the standards EN ISO 9001 and EN ISO/IEC 80079-34 gives a presumption of conformity with the respective modules with regard to the provisions in the modules that these standards cover, provided that the quality system takes into consideration the specificities of the concerned products. However, the manufacturer is free to apply other quality system models than those based on EN ISO 9001 for the purpose of complying with these modules.

4. Surveillance under the responsibility of the notified body

- 4.1. The purpose of surveillance is to make sure that the manufacturer duly fulfils the obligations arising out of the approved quality system.
- 4.2. The manufacturer shall, for assessment purposes, allow the notified body access to the manufacture, inspection, testing and storage sites and shall provide it with all necessary information, in particular:
 - (a) the quality system documentation,
 - (b) the quality records, such as inspection reports and test data, calibration data, qualification reports on the personnel concerned, etc.
- 4.3. The notified body shall carry out periodic audits to make sure that the manufacturer maintains and applies the quality system and shall provide the manufacturer with an audit report.
- 4.4. In addition, the notified body may pay unexpected visits to the manufacturer. During such visits the notified body may, if necessary, carry out product tests, or have them carried out, in order to verify that the quality system is functioning correctly. The notified body shall provide the manufacturer with a visit report and, if tests have been carried out, with a test report.

§ 192 Surveillance under the responsibility of the notified body

Surveillance under the responsibility of the notified body is limited only to the assessed area. Typically notified bodies specify the list of EU-type examination

certificates covered by their surveillance. As a part of such activities, notified bodies must inform relevant bodies in case of critical findings during audits.

5. CE marking, EU declaration of conformity and attestation of conformity

5.1. The manufacturer shall affix the CE marking and, under the responsibility of the notified body referred to in point 3.1, the latter's identification number to each individual product other than a component that is in conformity with the type described in the EU-type examination certificate and satisfies the applicable requirements of this Directive.

5.2. The manufacturer shall draw up a written EU declaration of conformity for each product model, other than a component and keep it at the disposal of the national authorities for 10 years after the product other than a component has been placed on the market. The EU declaration of conformity shall identify such product model for which it has been drawn up.

A copy of the EU declaration of conformity shall accompany every product, other than a component.

5.3. The manufacturer shall draw up a written attestation of conformity for each component model and keep it at the disposal of the national authorities for 10 years after the component has been placed on the market. The attestation of conformity shall identify the component model for which it has been drawn up. A copy of the attestation of conformity shall accompany every component.

§ 193 CE marking, EU declaration of conformity and attestation of conformity

As in this conformity assessment module (D) the notified body is involved in the production phase, the CE marking must be followed by the identification number of the notified body.

CE marking should not be affixed to a component (see section [§ 46](#) on components).

A written declaration of conformity should be issued by the manufacturer (or its authorised representative) except for components. For components a written attestation of conformity must be issued.

6. The manufacturer shall, for a period ending 10 years after the product has been placed on the market, keep at the disposal of the national authorities:

- (a) the documentation referred to in point 3.1,
- (b) the information relating to the change referred to in point 3.5, as approved,
- (c) the decisions and reports of the notified body referred to in points 3.5, 4.3 and 4.4.

§ 194 Obligations for the manufacturer: retention of documentation - quality

assurance

The manufacturer, or where relevant, the authorised representative or importer, shall, for a period ending at least 10 (ten) years after the product has been placed on the market, be able to make available to the national authorities:

- the documentation of the quality system;
- updating of the quality system;
- audit reports and certificates of the notified body.

The provision on "10 years after the product has been placed on the market" should be understood as related to the last item of the product model placed on the market.

Larger organisations have a certified quality management system according to the ISO 9000 standards. For these manufacturers it is recognised that it is difficult to keep all quality documents and all changes to the quality system for such a long period. It is the opinion of the ATEX Committee that the requirements in Annex IV, section 6 of the ATEX Directive 2014/34/EU are fulfilled if the manufacturer keeps at the disposal of the national authorities at least the actual quality management system documents plus the following documents which have to be kept for a period ending at least 10 years after the last piece of equipment was manufactured:

- audit reports and certificates of the ISO 9000 certifier. This will be one or two audit reports per year that include the actual state at that moment of the quality system with changes;
- audit reports and notifications of the notified body that issued the notification of quality assurance of the production process.

The above consideration is against the background that this documentation shall always be sufficient so as to enable surveillance authorities to determine that the relevant conformity assessment procedure(s) was/were applied in a satisfactory manner and that the relevant obligations of the Directive were fulfilled.

7. Each notified body shall inform its notifying authority of quality system approvals issued or withdrawn, and shall, periodically or upon request, make available to its notifying authority the list of quality system approvals refused, suspended or otherwise restricted.

Each notified body shall inform the other notified bodies of quality system approvals which it has refused, suspended, withdrawn or otherwise restricted, and, upon request, of quality system approvals which it has issued.

§ 195 Obligations for the notified body

Notified bodies are obliged to co-operation and coordination of its activity. In particular, notified bodies have a general obligation to inform national market surveillance authorities and the other notified bodies about the assessments of quality systems they have carried out.

8. **Authorised representative**

The manufacturer's obligations set out in points 3.1, 3.5, 5 and 6 may be fulfilled by his authorised representative, on his behalf and under his responsibility, provided that they are specified in the mandate.

§ 196 Authorised representative

According to the mandate contractually agreed with the manufacturer, the authorised representative can be entitled to lodge the application for the assessment of the quality system and to fulfil the obligations related to information, marking, declaration or attestation of conformity, and to retaining the relevant documentation.

ANNEX V

MODULE F: CONFORMITY TO TYPE BASED ON PRODUCT VERIFICATION

1. Conformity to type based on product verification is the part of a conformity assessment procedure whereby the manufacturer fulfils the obligations laid down in points 2 and 5 and ensures and declares on his sole responsibility that the products concerned, which have been subject to the provisions of point 3, are in conformity with the type described in the EU-type examination certificate and satisfy the requirements of this Directive that apply to them.

§ 197 Conformity to type based on product verification

Module F "Conformity to type based on product verification" as Annex V to the ATEX Directive 2014/34/EU (indicated as "Product verification" in the previous Directive 94/9/EC) is one of modules that may be applied after the Module B (EU-type examination certificate, Annex III).

In this conformity assessment procedure, examination and tests of every product are carried out by a notified body to check the conformity of the equipment, protective system or device with the requirements of Directive 2014/34/EU, and draws up a certificate of conformity.

2. Manufacturing

The manufacturer shall take all measures necessary so that the manufacturing process and its monitoring ensure conformity of the manufactured products with the approved type described in the EU-type examination certificate and with the requirements of this Directive that apply to them.

§ 198 Manufacturing

The manufacturer has to ensure compliance of the manufactured products to the approved EU-type (under module B) and the legislative requirements.

For the general obligations of manufacturers, see section [§ 74](#).

3. **Verification**

A notified body chosen by the manufacturer shall carry out appropriate examinations and tests in order to check the conformity of the products with the approved type described in the EU-type examination certificate and with the appropriate requirements of this Directive.

The examinations and tests to check the conformity of the products with the appropriate requirements shall be carried out by examination and testing of every product as specified in point 4.

4. **Verification of conformity by examination and testing of every product**

4.1. All products shall be individually examined and appropriate tests set out in the relevant harmonised standard(s) and/or equivalent tests set out in other relevant technical specifications, shall be carried out in order to verify conformity with the approved type described in the EU-type examination certificate and with the appropriate requirements of this Directive.

In the absence of such a harmonised standard, the notified body concerned shall decide on the appropriate tests to be carried out.

4.2. The notified body shall issue a certificate of conformity in respect of the examinations and tests carried out, and shall affix its identification number to each approved product or have it affixed under its responsibility.

The manufacturer shall keep the certificates of conformity available for inspection by the national authorities for 10 years after the product has been placed on the market.

§ 199 Verification

The notified body has to carry out appropriate examinations and tests (testing of every product or statistical checks).

The notified body takes into account the technical documentation but does not examine it, as it has been already examined under module B.

The notified body issues a certificate of conformity and:

- affixes its identification number or delegates to the manufacturer the affixing of its identification number,
- keeps a record of its decisions and other relevant information, and
- informs its notifying authorities and the other bodies about the examinations performed.

5. **CE marking, EU declaration of conformity and attestation of conformity**

5.1. The manufacturer shall affix the CE marking and, under the responsibility of the notified body referred to in point 3, the latter's identification number to each individual product other than a component that is in conformity with the approved

type described in the EU-type examination certificate and satisfies the applicable requirements of this Directive.

- 5.2. The manufacturer shall draw up a written EU declaration of conformity for each product model other than a component and keep it at the disposal of the national authorities, for 10 years after the product, other than a component, has been placed on the market. The EU declaration of conformity shall identify such product model for which it has been drawn up.

A copy of the EU declaration of conformity shall accompany every product other than a component.

If the notified body referred to in point 3 agrees and under its responsibility, the manufacturer may also affix the notified body's identification number to the products other than components.

- 5.3. The manufacturer shall draw up a written attestation of conformity for each component model and keep it at the disposal of the national authorities for 10 years after the component has been placed on the market. The attestation of conformity shall identify the component model for which it has been drawn up. A copy of the attestation of conformity shall accompany every component.

§ 200 CE marking, EU declaration of conformity and attestation of conformity

As in this conformity assessment module (F) the notified body is involved in the production phase, the CE marking must be followed by the identification number of the notified body.

CE marking should not be affixed to a component, but only the identification number of the notified body involved in the production phase.

A written declaration of conformity should be issued by the manufacturer (or its authorised representative) except for components. For components a written attestation of conformity must be issued.

6. If the notified body agrees and under its responsibility, the manufacturer may affix the notified body's identification number to the products during the manufacturing process.

§ 201 The notified body's identification number

This is a matter of contractual or informal agreement between the manufacturer and the notified body.

7. Authorised representative

The manufacturer's obligations may be fulfilled by his authorised representative, on his behalf and under his responsibility, provided that they are specified in the

mandate. An authorised representative may not fulfil the manufacturer's obligations set out in point 2.

§ 202 Authorised representative

According to the mandate contractually agreed with the manufacturer, the authorised representative can be entitled to fulfil the manufacturer's obligations, with the exception of those related to the conformity of the manufactured products with the approved type.

ANNEX VI

MODULE C1: CONFORMITY TO TYPE BASED ON INTERNAL PRODUCTION CONTROL PLUS SUPERVISED PRODUCT TESTING

1. Conformity to type based on internal production control plus supervised product testing is the part of a conformity assessment procedure whereby the manufacturer fulfils the obligations laid down in points 2, 3 and 4, and ensures and declares on his sole responsibility that the products concerned are in conformity with the type described in the EU-type examination certificate and satisfy the requirements of this Directive that apply to them.

§ 203 Conformity to type based on internal production control plus supervised product testing

Module C1 "Conformity to type based on internal production control plus supervised product testing" as Annex VI to the ATEX Directive 2014/34/EU (indicated as "Conformity to type" in the previous Directive 94/9/EC) is one of modules that may be applied after the Module B (EU-type examination certificate, Annex III).

In this conformity assessment procedure, tests are carried out by a manufacturer on each piece of equipment manufactured, to check the explosion protection aspects of the design. Such tests are carried out under the responsibility of a notified body.

2. Manufacturing

The manufacturer shall take all measures necessary so that the manufacturing process and its monitoring ensure conformity of the manufactured products with the type described in the EU-type examination certificate and with the requirements of this Directive that apply to them.

§ 204 Manufacturing

The manufacturer has to ensure compliance of the manufactured products to the approved EU-type (under module B) and the legislative requirements.

For the general obligations of manufacturers, see section [§ 74](#).

3. **Product checks**

For each individual product manufactured one or more tests on one or more specific aspects of the product shall be carried out by the manufacturer or on his behalf, in order to verify conformity with the type described in the EU-type examination certificate and with the corresponding requirements of this Directive. The tests shall be carried out under the responsibility of a notified body, chosen by the manufacturer.

The manufacturer shall, under the responsibility of the notified body, affix the notified body's identification number during the manufacturing process.

§ 205 Product checks

The manufacturer has (directly or on his behalf) to carry out tests on one or more specific aspects of the product. He has to choose a notified body which assume the responsibility of such tests, and to affix the notified body's identification number during the manufacturing process.

The notified body takes into account the technical documentation but does not examine it, as it has been already examined under module B.

The notified body has to keep record of its decisions and other relevant information, and informs authorities and the other bodies about the examinations performed.

4. **CE marking, EU declaration of conformity and attestation of conformity**

4.1. The manufacturer shall affix the CE marking to each individual product other than a component that is in conformity with the type described in the EU-type examination certificate and satisfies the applicable requirements of this Directive.

4.2. The manufacturer shall draw up a written EU declaration of conformity for a product model other than a component and keep it at the disposal of the national authorities for 10 years after the product, other than a component has been placed on the market. The EU declaration of conformity shall identify such product model for which it has been drawn up.

A copy of the EU declaration of conformity shall accompany every product, other than a component.

4.3. The manufacturer shall draw up a written attestation of conformity for each component model and keep it at the disposal of the national authorities for 10 years after the component has been placed on the market. The attestation of conformity shall identify the component model for which it has been drawn up. A copy of the attestation of conformity shall accompany every component.

§ 206 CE marking, EU declaration of conformity and attestation of conformity

As in this conformity assessment module (C1) the notified body is involved in the production phase, the CE marking must be followed by the identification number of the notified body.

CE marking should not be affixed to a component, but only the identification number of the notified body involved in the production phase.

The written EU declaration of conformity should be issued by the manufacturer (or its authorised representative) except for components. For components a written attestation of conformity must be issued.

5. Authorised representative

The manufacturer's obligations set out in point 4 may be fulfilled by his authorised representative, on his behalf and under his responsibility, provided that they are specified in the mandate.

§ 207 Authorised representative

According to the mandate contractually agreed with the manufacturer, the authorised representative can be entitled to fulfil the manufacturer's obligations related to CE marking, EU declaration of conformity and attestation of conformity.

ANNEX VII

MODULE E: CONFORMITY TO TYPE BASED ON PRODUCT QUALITY ASSURANCE

1. Conformity to type based on product quality assurance is that part of a conformity assessment procedure whereby the manufacturer fulfils the obligations laid down in points 2 and 5, and ensures and declares on his sole responsibility that the products concerned are in conformity with the type described in the EU-type examination certificate and satisfy the requirements of this Directive that apply to them.

§ 208 Conformity to type based on product quality assurance

Module E "Conformity to type based on product quality assurance" as Annex VII to the ATEX Directive 2014/34/EU (indicated as "Product quality assurance" in the previous Directive 94/9/EC) is one of modules that may be applied after the Module B (EU-type examination certificate, Annex III).

This conformity assessment procedure is based on a quality system approved by a notified body for the final inspection and testing of equipment subject to on-going surveillance.

2. Manufacturing

The manufacturer shall operate an approved quality system for final product inspection and testing of the products concerned as specified in point 3 and shall be subject to surveillance as specified in point 4.

§ 209 Manufacturing

The manufacturer has to implement and manage an approved quality system for final product inspection and testing of his products, in order to ensure compliance of the manufactured products to the approved EU-type (under module B) and the legislative requirements.

For the general obligations of manufacturers, see section [§ 74](#).

3. Quality system

3.1. The manufacturer shall lodge an application for assessment of his quality system with the notified body of his choice, for the products concerned.

The application shall include:

- (a) the name and address of the manufacturer and, if the application is lodged by the authorised representative, his name and address as well,
- (b) a written declaration that the same application has not been lodged with any other notified body,
- (c) all relevant information for the product category envisaged,
- (d) the documentation concerning the quality system, and
- (e) the technical documentation of the approved type and a copy of the EU-type examination certificate.

3.2. The quality system shall ensure compliance of the products with the type described in the EU-type examination certificate and with the applicable requirements of this Directive.

All the elements, requirements and provisions adopted by the manufacturer shall be documented in a systematic and orderly manner in the form of written policies, procedures and instructions. The quality system documentation shall permit a consistent interpretation of the quality programmes, plans, manuals and records.

It shall, in particular, contain an adequate description of:

- (a) the quality objectives and the organisational structure, responsibilities and powers of the management with regard to product quality,
- (b) the examinations and tests that will be carried out after manufacture,

- (c) the quality records, such as inspection reports and test data, calibration data, qualification reports on the personnel concerned, etc.,
- (d) the means of monitoring the effective operation of the quality system.

3.3. The notified body shall assess the quality system to determine whether it satisfies the requirements referred to in point 3.2.

It shall presume conformity with those requirements in respect of the elements of the quality system that comply with the corresponding specifications of the relevant harmonised standard.

In addition to experience in quality management systems, the auditing team shall have at least one member with experience of evaluation in the relevant product field and product technology concerned, and knowledge of the applicable requirements of this Directive. The audit shall include an assessment visit to the manufacturer's premises. The auditing team shall review the technical documentation referred to in point 3.1(e) in order to verify the manufacturer's ability to identify the relevant requirements of this Directive and to carry out the necessary examinations with a view to ensuring compliance of the product with those requirements.

The decision shall be notified to the manufacturer. The notification shall contain the conclusions of the audit and the reasoned assessment decision.

3.4. The manufacturer shall undertake to fulfil the obligations arising out of the quality system as approved and to maintain it so that it remains adequate and efficient.

3.5. The manufacturer shall keep the notified body that has approved the quality system informed of any intended change to the quality system.

The notified body shall evaluate any proposed changes and decide whether the modified quality system will continue to satisfy the requirements referred to in point 3.2 or whether a reassessment is necessary.

It shall notify the manufacturer of its decision. The notification shall contain the conclusions of the examination and the reasoned assessment decision.

§ 210 Quality system

The quality system must include the following elements, to be documented:

- quality objectives,
- organisational structure,
- tests (carried out after the manufacturing),
- quality records, and
- monitoring methods.

Tests carried out before or during the manufacturing, as well as manufacturing techniques, are not part of the quality system under module E (as it is the case for modules D), because module E targets the final product quality and not the quality of the whole production process (as it is the case for module D).

4. Surveillance under the responsibility of the notified body

- 4.1. The purpose of surveillance is to make sure that the manufacturer duly fulfils the obligations arising out of the approved quality system.
- 4.2. The manufacturer shall, for assessment purposes, allow the notified body access to the manufacture, inspection, testing and storage sites and shall provide it with all necessary information, in particular:
 - (a) the quality system documentation,
 - (b) the quality records, such as inspection reports and test data, calibration data, qualification reports on the personnel concerned, etc.
- 4.3. The notified body shall carry out periodic audits to make sure that the manufacturer maintains and applies the quality system and shall provide the manufacturer with an audit report.
- 4.4. In addition, the notified body may pay unexpected visits to the manufacturer. During such visits the notified body may, if necessary, carry out product tests, or have them carried out, in order to verify that the quality system is functioning correctly. The notified body shall provide the manufacturer with a visit report and, if tests have been carried out, with a test report.

§ 211 Surveillance under the responsibility of the notified body

The notified body performs periodic audits in order to assess and survey the quality system. Audits include:

- control of the quality system,
- inspections, and
- product tests.

The notified body takes into account the technical documentation but does not examine it, as it has been already examined under module B.

5. CE marking, EU declaration of conformity and attestation of conformity

- 5.1. The manufacturer shall affix the CE marking and, under the responsibility of the notified body referred to in point 3.1, the latter's identification number to each individual product other than a component that is in conformity with the type described in the EU-type examination certificate and satisfies the applicable requirements of this Directive.
- 5.2. The manufacturer shall draw up a written EU declaration of conformity for each product model, other than a component and keep it at the disposal of the national authorities for 10 years after the product other than a component has been placed on the market. The EU declaration of conformity shall identify such product model for which it has been drawn up.

A copy of the EU declaration of conformity shall accompany every product other than a component.

- 5.3. The manufacturer shall draw up a written attestation of conformity for each component model and keep it at the disposal of the national authorities for 10 years after the component has been placed on the market. The attestation of conformity shall identify the component model for which it has been drawn up. A copy of the attestation of conformity shall accompany every component.

§ 212 CE marking, EU declaration of conformity and attestation of conformity

As in this conformity assessment module (E) the notified body is involved in the production phase, the CE marking must be followed by the identification number of the notified body.

CE marking should not be affixed to a component, but only the identification number of the notified body involved in the production phase.

A written declaration of conformity should be issued by the manufacturer (or its authorised representative) except for components. For components a written attestation of conformity must be issued.

6. The manufacturer shall, for a period ending 10 years after the product has been placed on the market, keep at the disposal of the national authorities:
- (a) the documentation referred to in point 3.1,
 - (b) the information relating to the change referred to in point 3.5, as approved,
 - (c) the decisions and reports of the notified body referred to in points 3.5, 4.3 and 4.4.

§ 213 Obligations for the manufacturer

The provision on "10 years after the product has been placed on the market" should be understood as related to the last item of the product model placed on the market.

7. Each notified body shall inform its notifying authority of quality system approvals issued or withdrawn, and shall, periodically or upon request, make available to its notifying authority the list of quality system approvals refused, suspended or otherwise restricted.

Each notified body shall inform the other notified bodies of quality system approvals which it has refused, suspended or withdrawn, and, upon request, of quality system approvals which it has issued.

§ 214 Obligations for the notified body

Notified bodies are obliged to co-operation and coordination of its activity. In particular, notified bodies have a general obligation to inform national market surveillance authorities and the other notified bodies about the assessments of quality systems they have carried out.

8. Authorised representative

The manufacturer's obligations set out in points 3.1, 3.5, 5 and 6 may be fulfilled by his authorised representative, on his behalf and under his responsibility, provided that they are specified in the mandate.

§ 215 Authorised representative

According to the mandate contractually agreed with the manufacturer, the authorised representative can be entitled to lodge the application for the assessment of the quality system and to fulfil the obligations related to information, marking, declaration or attestation of conformity, and to retaining the relevant documentation.

ANNEX VIII

MODULE A: INTERNAL PRODUCTION CONTROL

1. Internal production control is the conformity assessment procedure whereby the manufacturer fulfils the obligations laid down in points 2, 3 and 4, and ensures and declares on his sole responsibility that the products concerned satisfy the requirements of this Directive that apply to them.

§ 216 Internal production control

Annex VIII to the ATEX Directive 2014/34/EU includes module A "Internal production control" (indicated as "Internal control of production" in the previous Directive 94/9/EC). In this conformity assessment procedure, the product and quality system assessment procedure is carried out by the manufacturer.

In the cases of Article 13(1)(b)(ii) (equipment-group I and II, category M2 and 2, neither internal combustion engines nor electrical equipment), communication/deposit of the technical documentation to a notified body, and retention of such documentation by the notified body, are required.

2. Technical documentation

The manufacturer shall establish the technical documentation. The documentation shall make it possible to assess the product's conformity to the relevant requirements, and shall include an adequate analysis and assessment of the risk(s).

The technical documentation shall specify the applicable requirements and cover, as far as relevant for the assessment, the design, manufacture and operation of the product. The technical documentation shall contain at least the following elements:

- (a) a general description of the product,
- (b) conceptual design and manufacturing drawings and schemes of components, sub-assemblies, circuits, etc.
- (c) descriptions and explanations necessary for the understanding of those drawings and schemes and the operation of the product,
- (d) a list of the harmonised standards applied in full or in part the references of which have been published in the *Official Journal of the European Union* and, where those harmonised standards have not been applied, descriptions of the solutions adopted to meet the essential health and safety requirements of this Directive, including a list of other relevant technical specifications applied. In the event of partly applied harmonised standards, the technical documentation shall specify the parts which have been applied,
- (e) results of design calculations made, examinations carried out, etc., and
- (f) test reports.

§ 217 *Technical documentation*

In this module there is no involvement of a notified body in the conformity assessment activities. The required tests may be done by manufacturer itself or in any independent laboratory the manufacturer considers adequate.

The need to carry out tests may arise from the technical solution adopted and/or by the use of standards (harmonised or other).

In case of equipment-group I and II, category M2 and 2, technical documentation identifying product should be communicated to a notified body, which retains it in its facilities located in the European Union.

The notified body does not examine the conformity of such documentation file; in some cases it can be requested that the documentation file is sealed. Documentation file is stored in notified body's archives upon the request of manufacturer (or its authorised representative).

For received and stored documentation, the notified body issues a "Confirmation of product documentation file retention/deposit" typically identified by codification numbers and/or letters.

3. **Manufacturing**

The manufacturer shall take all measures necessary so that the manufacturing process and its monitoring ensure compliance of the manufactured products with the technical documentation referred to in point 2 and with the requirements of this Directive that apply to them.

§ 218 Manufacturing

The manufacturer has to draw up the technical documentation and to ensure compliance of the manufactured products to the legislative requirements.

For the general obligations of manufacturers, see section [§ 74](#).

4. CE marking, EU declaration of conformity and attestation of conformity

4.1. The manufacturer shall affix the CE marking to each individual product other than a component that satisfies the applicable requirements of this Directive.

4.2. The manufacturer shall draw up a written EU declaration of conformity for a product model other than a component and keep it together with the technical documentation at the disposal of the national authorities for 10 years after the product, other than a component, has been placed on the market. The EU declaration of conformity shall identify such product model for which it has been drawn up.

A copy of the EU declaration of conformity shall accompany every product other than a component.

4.3. The manufacturer shall draw up a written attestation of conformity for each component model and keep it together with the technical documentation at the disposal of the national authorities for 10 years after the component has been placed on the market. The attestation of conformity shall identify the component for which it has been drawn up. A copy of the attestation of conformity shall accompany every component.

§ 219 CE marking, EU declaration of conformity and attestation of conformity

As in this conformity assessment module (A) no notified body is involved in the production phase, the CE marking must not be followed by any notified body's identification number.

CE marking should not be affixed to a component.

A written declaration of conformity should be issued by the manufacturer (or its authorised representative) except for components. For components a written attestation of conformity must be issued.

5. Authorised representative

The manufacturer's obligations set out in point 4 may be fulfilled by his authorised representative, on his behalf and under his responsibility, provided that they are specified in the mandate.

§ 220 Authorised representative

According to the mandate contractually agreed with the manufacturer, the authorised representative can be entitled to fulfil the manufacturer's obligations related to CE marking, EU declaration of conformity and attestation of conformity.

ANNEX IX

MODULE G: CONFORMITY BASED ON UNIT VERIFICATION

1. Conformity based on unit verification is the conformity assessment procedure whereby the manufacturer fulfils the obligations laid down in points 2, 3 and 5, and ensures and declares on his sole responsibility that the product concerned, which has been subject to the provisions of point 4, is in conformity with the requirements of this Directive that apply to it.

§ 221 *Conformity based on unit verification*

Annex IX to the ATEX Directive 2014/34/EU includes module G "Conformity based on unit verification" (indicated as "Unit verification" in the previous Directive 94/9/EC). In this conformity assessment procedure, the principle is that all products are fully assessed and tested by a notified body. In fact, the notified body examines individual equipment or protective system and carries out tests as defined in the harmonised standards, if they exist, or otherwise in European, international or national standards, or conduct equivalent tests to ensure conformity with the relevant requirements of Directive 2014/34/EU, and draws up a certificate of conformity.

Unit verification may be applied to unique production and also to limited series production.

2. **Technical documentation**

- 2.1. The manufacturer shall establish the technical documentation and make it available to the notified body referred to in point 4. The documentation shall make it possible to assess the product's conformity with the relevant requirements, and shall include an adequate analysis and assessment of the risk(s). The technical documentation shall specify the applicable requirements and cover, as far as relevant for the assessment, the design, manufacture and operation of the product. The technical documentation shall contain at least the following elements:
 - (a) a general description of the product,
 - (b) conceptual design and manufacturing drawings and schemes of components, sub-assemblies, circuits, etc.,
 - (c) descriptions and explanations necessary for the understanding of those drawings and schemes and the operation of the product,
 - (d) a list of the harmonised standards applied in full or in part the references of which have been published in the *Official Journal of the European Union* and, where those harmonised standards have not been applied, descriptions of the solutions

adopted to meet the essential health and safety requirements of this Directive, including a list of other relevant technical specifications applied. In the event of partly applied harmonised standards, the technical documentation shall specify the parts which have been applied,

- (e) results of design calculations made, examinations carried out, etc., and
- (f) test reports.

2.2. The manufacturer shall keep the technical documentation at the disposal of the relevant national authorities for 10 years after the product has been placed on the market.

§ 222 Technical documentation

The notified body needs to be provided with the technical documentation as indicated, in order to be able to carry out the appropriate examinations and tests on the product.

3. Manufacturing

The manufacturer shall take all measures necessary so that the manufacturing process and its monitoring ensure conformity of the manufactured product with the applicable requirements of this Directive.

§ 223 Manufacturing

The manufacturer has to draw up the technical documentation and to ensure compliance of the manufactured products to the legislative requirements.

For the general obligations of manufacturers, see section [§ 74](#).

4. Verification

A notified body chosen by the manufacturer shall carry out appropriate examinations and tests, set out in the relevant harmonised standards and/or equivalent tests set out in other relevant technical specifications, to check the conformity of the product with the applicable requirements of this Directive, or have them carried out. In the absence of such a harmonised standard the notified body concerned shall decide on the appropriate tests to be carried out.

The notified body shall issue a certificate of conformity in respect of the examinations and tests carried out and shall affix its identification number to the approved product, or have it affixed under its responsibility.

The manufacturer shall keep the certificates of conformity at the disposal of the national authorities for 10 years after the product has been placed on the market.

§ 224 Verification

The notified body carries out appropriate examinations including routine specifications and tests. For some more complex products (e.g. encapsulated items), the test may need to be done during manufacturing process, too.

The manufacturer must establish and maintain procedures for product identification during all stages of production, testing, final inspection and placing on the market.

5. CE marking, EU declaration of conformity and attestation of conformity

5.1. The manufacturer shall affix the CE marking and, under the responsibility of the notified body referred to in point 4, the latter's identification number to each product other than a component that satisfies the applicable requirements of this Directive.

5.2. The manufacturer shall draw up a written EU declaration of conformity and keep it at the disposal of the national authorities for 10 years after the product, other than a component has been placed on the market. The EU declaration of conformity shall identify such product for which it has been drawn up.

A copy of the EU declaration of conformity shall accompany every product, other than a component.

5.3. The manufacturer shall draw up a written attestation of conformity and keep it at the disposal of the national authorities for 10 years after the component has been placed on the market. The attestation of conformity shall identify the component for which it has been drawn up. A copy of the attestation of conformity shall accompany every component.

§ 225 CE marking, EU declaration of conformity and attestation of conformity

The manufacturer has to affix the CE marking and, under the responsibility of the notified body, its identification number.

The manufacturer draws up a written declaration of conformity and keeps it together with the technical documentation, the certificate of conformity and other relevant information at the disposal of the national authorities.

6. Authorised representative

The manufacturer's obligations set out in points 2.2 and 5 may be fulfilled by his authorised representative, on his behalf and under his responsibility, provided that they are specified in the mandate.

§ 226 Authorised representative

According to the mandate contractually agreed with the manufacturer, the authorised representative can be entitled to fulfil the manufacturer's obligations related to

retaining technical documentation and those on CE marking, EU declaration of conformity and attestation of conformity.

ANNEX X

EU DECLARATION OF CONFORMITY (No XXXX) ⁽¹⁾

1. Product model/product (product, type, batch or serial number):
2. Name and address of the manufacturer and, where applicable, his authorised representative:
3. This declaration of conformity is issued under the sole responsibility of the manufacturer.
4. Object of the declaration (identification of product allowing traceability; it may, where necessary for the identification of the product, include an image):
5. The object of the declaration described above is in conformity with the relevant Union harmonisation legislation:
6. References to the relevant harmonised standards used or references to the other technical specifications in relation to which conformity is declared:
7. Where applicable, the notified body ... (name, number) performed ... (description of intervention) and issued the certificate:
8. Additional information:

Signed for and on behalf of:

(place and date of issue):

(name, function) (signature):

⁽¹⁾ It is optional for the manufacturer to assign a number to the declaration of conformity.

§ 227 The EU declaration of conformity

The EU declaration of conformity, to be drafted and signed by the manufacturer, is required by Article 14 of the ATEX Directive 2014/34/EU (see [section § 93](#)).

Annex X includes a model structure for the EU declaration of conformity, based on Annex III to the [Decision No 768/2008/EC](#).

Brief comments for each point of the model for the EU declaration of conformity are shown in **Table 8: EU declaration of conformity** below.

Table 8: EU declaration of conformity

EU DECLARATION OF CONFORMITY (No XXXX)	Heading of the EU declaration of conformity. The manufacturer is not required to assign a number but it could be useful for traceability purposes.
1. Product model / product (product, type, batch or serial number)	This point should reflect the unique identification of the product.
2. Name and address of the manufacturer and, where applicable, his authorised representative	Straightforward, noting that the name (and/or the identification mark) on the product places the named organisation in the position of manufacturer (or his authorised representative in the European Union).
3. This declaration of conformity is issued under the sole responsibility of the manufacturer.	Reaffirming the overall responsibility of the manufacturer on the product to be placed or put into service on the EU market.
4. Object of the declaration (identification of product allowing traceability; it may, where necessary for the identification of the product, include an image)	This includes the description of the concerned product: it could be a descriptive product designation e.g. Motor Control Unit Type ABC 123 and its intended use. For an assembly it should list the items in the assembly that are ATEX equipment in their own right, and which have been separately assessed. Indication of all relevant provisions fulfilled by the equipment would include the markings affixed on the product, e.g. equipment group II, category 2 G (IIB T4).
5. The object of the declaration described above is in conformity with the relevant Union harmonisation legislation	The references of the legislative acts (Regulations or Directives) to which conformity of the product is declared. If it is a multi-directive declaration, it should already be clear from the heading which directives the product conforms to. It is sufficient to indicate the codification or numbering of the legislative act (e.g. "Directive 2014/34/EU", "Directive 2006/42/EC", etc.) with no need to indicate the complete title and the publication references according to Article 14.3.
6. References to the relevant harmonised standards used or references to the other technical specifications in relation to which conformity is declared	The European harmonised standards quoted in the technical documentation file shall be indicated here. They should be indicated as listed in the relevant publication in the Official Journal of the European Union, being sufficient to indicate the number and the year of publication (e.g. "EN 1010-1:2004+A1:2010", "EN 60079-0:2012", etc.) and not by the national editions (BS, DIN, NF, UNI, UNE etc.), also taking into consideration that the year could be different. Where appropriate, other standards and/or technical specification used, as quoted in the technical documentation, should be indicated here, along with the justification for the use of a non-harmonised standard.
7. Where applicable, the notified body ... (name, number) performed ... (description of intervention) and issued the certificate	Name and number of the notified body (or bodies) conducting the EU-type examination. Indication of the notified body's identification number, when applicable (where involved in the production phase) can be seen as a support to market surveillance actions. In the case of category 2 non-electrical equipment, it should refer to the notified body holding the copy of the technical

	<p>documentation file.</p> <p>Where relevant, if the body responsible for oversight of the QA regime is not the same as the one issuing the original certificate, it should be named separately. However, the name and address of a notified body involved in the production phase is not a mandatory requirement.</p> <p>There shall be no reference to a notified body certificate unless it is one coming within the scope of the Directive. Voluntary certificates issued by bodies in their "private" capacity as certification bodies should be included in the technical documentation file as part of the evidence of conformity but should not be quoted on the declaration of conformity.</p>
<p>8. Additional information</p>	<p>Any other additional information that could be considered relevant for the declaration.</p>
<p>Signed for and on behalf of: (place and date of issue) (name, function) (signature)</p>	<p>Identification of the signatory who has been empowered to enter into commitments on behalf of the manufacturer. The signatory needs to be a responsible officer of the manufacturer or of the authorised representative.</p>

ANNEX XI

PART A

**Repealed Directive with list of the successive amendments thereto
(referred to in Article 43)**

Directive 94/9/EC of the European Parliament and
of the Council
(OJ L 100, 19.4.1994, p. 1).

Regulation (EC) No 1882/2003 of the European
Parliament and of the Council
(OJ L 284, 31.10.2003, p. 1).

Only point 8 of Annex I

Regulation (EU) No 1025/2012 of the European
Parliament and of the Council
(OJ L 316, 14.11.2012, p. 12).

Only point (c) of Article 26(1)

PART B

**Time limits for transposition into national law and dates of application
(referred to in Article 43)**

Directive	Time-limit for transposition	Date of application
94/9/EC	1 September 1995	1 March 1996

§ 228 References of the repealed Directive

These references come from the previous ATEX Directive 94/9/EC and its amendments.

ANNEX XII

CORRELATION TABLE

Directive 94/9/EC	This Directive
Article 1(1)	Article 1(1)(a)
Article 1(2)	Article 1(1)(b)
–	Article 1(1)(c)
Article 1(3)	Article 2(1) to (9)
–	Article 2(10) to (26)
Article 1(4)	Article 1(2)
Article 2	Article 3
Article 3	Article 4
Article 4	Article 5
Article 5(1), first subparagraph	–
Article 5(1), second subparagraph	Article 12(2)
Article 5(2)	Article 12(1)
Article 5(3)	–
–	Articles 6 to 11
–	
Article 6(1) and (2)	–
Article 6(3)	Article 39(1) to (4)
–	Article 39(5), first subparagraph
Article 6(4)	Article 39(5), second subparagraph
Article 7	–
Article 8(1) to (6)	Article 13(1) to (6)
Article 8(7)	–

–	Articles 14 and 15
Article 9	–
Article 10(1)	–
Article 10(2)	Article 16(1)
Article 10(3)	–
–	Article 16(2) to (6)
–	Articles 17 to 33
Article 11	–
–	Articles 34 to 38
Articles 12 and 13	–
–	Article 40
–	Article 41(1)
Article 14(1)	–
Article 14(2)	Article 41(2)
Article 14(3)	–
Article 15(1)	Article 42(1)
Article 15(2)	–
–	Article 42(2)
–	Articles 43 and 44
Article 16	Article 45
Annexes I to IX	Annexes I to IX
Annex X	–
Annex XI	–
–	Annex X
–	Annex XI
–	Annex XII

§ 229 Correlation table

As recast legislation, the ATEX Directive 2014/34/EU includes a correlation table linking the new articles and annexes to those of the previous Directive 94/9/EC. Only sections with a direct correlation are indicated; in other cases, there is the sign "–", when a specific section has been rewritten and restructured, or new sections have been added. For example, Annex XI of Directive 94/9/EC approximately corresponds to Chapter 4 (Articles 17 to 33) of Directive 2014/34/EU; Chapter 2 (Articles 6 to 11) of Directive 2014/34/EU are new contents not present in Directive 94/9/EC.

STATEMENT OF THE EUROPEAN PARLIAMENT

The European Parliament considers that only when and insofar as implementing acts in the sense of Regulation (EU) No 182/2011 are discussed in meetings of committees, can the latter be considered as ‘comitology committees’ within the meaning of Annex I to the Framework Agreement on the relations between the European Parliament and the European Commission. Meetings of committees thus fall within the scope of point 15 of the Framework Agreement when and insofar as other issues are discussed.

§ 230 Statement of the European Parliament

The final statement was added by the European Parliament when finally approving the text of the ATEX Directive 2014/34/EU. It deals with comitology, it is to say, the status of the ATEX Committee and its powers with regards to the relationship between the EU co-legislators (European Parliament and Council) and the European Commission.

APPLICATION OF DIRECTIVE 2014/34/EU ALONGSIDE OTHERS THAT MAY APPLY

In principle, if a product is within the scope of other Union harmonisation legislation (directives, regulations) at the same time, all directives have to be applied in parallel to fulfil the provisions of each directive.

In this context it is important to note that a notified body is only allowed to cover aspects related to two or more directives if the body is notified under all directives with an appropriate scope.

§ 231 *Electromagnetic Compatibility Directive 2014/30/EU (EMC)*

In the case of the **Electromagnetic Compatibility (EMC) Directive 2014/30/EU**, the ATEX Directive 2014/34/EU has to be applied to fulfil the requirements concerning "explosive atmospheres" safety requirements. The EMC Directive must also be applied so as to ensure that the product does not cause electromagnetic disturbance and that its normal operation is not affected by such disturbances. There will be some applications, where the "normal" level for electromagnetic immunity provided by Directive 2004/108/EC might not be sufficient for granting the necessary immunity level for safe performance under the scope of Directive 2014/34/EU. In this case the manufacturer is required to specify the electromagnetic immunity achieved by his products according to Annex II 1.2.7 to Directive 2014/34/EU. For example, protective systems where the performance of data acquisition and data transmission may have direct influence on explosion safety.

The Electromagnetic Compatibility Directive 2014/30/EU, replacing the previous Directive 2004/108/EC, is applicable from 20 April 2016.

§ 232 *Low Voltage Directive 2014/35/EU (LVD)*

Products for use in potentially explosive atmospheres are explicitly excluded from the scope of the **Low Voltage Directive 2014/35/EU (LVD)**. Therefore "Low Voltage essential objectives" have to be covered by the Directive 2014/34/EU (see Annex II 1.2.7). The standards published in the Official Journal of the European Union with reference to Directive 2006/95/EC may be listed in the EU declaration of conformity to fulfil the requirements 1.2.7 of Annex II to Directive 2014/34/EU. Not excluded from the scope of the LVD are the safety, controlling and regulating devices mentioned in Article 1(1)(b) of Directive 2014/34/EU which are intended for use outside potentially explosive atmospheres but required for or contributing to the safe functioning of equipment and protective systems. In such cases both Directives shall be applied.

Note: These requirements are reproduced in the European harmonised standards for electrical equipment intended for use in potentially explosive atmospheres. To align with the respective conformity assessment regimes of ATEX and LVD, the harmonised standards do not require that a notified body issuing an EU-type examination certificate for ATEX should verify that these requirements have been met but that the manufacturer shall declare that they have been met. This is reflected in the contents of the declaration of conformity mentioned above.

The Low Voltage Directive 2014/35/EU, replacing the previous Directive 2006/95/EC, is applicable from 20 April 2016.

§ 233 Machinery Directive 2006/42/EC (MD)

The relation between the ATEX Directive 2014/34/EU and the **Machinery Directive 2006/42/EC** is different from others. Directive 2014/34/EU, which is a "specific Directive" within the meaning of Article 3 of the Machinery Directive, contains very specific and detailed requirements to avoid hazards due to potentially explosive atmospheres, while the Machinery Directive itself contains only very general requirements against explosion hazards (see *Annex I, 1.5.7 to Directive 2006/42/EC*).

With regard to explosion protection in a potentially explosive atmosphere, Directive 2014/34/EU takes precedence and has to be applied. So equipment that complies with ATEX, and which is also a machine can be assumed to comply with the specific essential safety requirements concerning ignition risk with respect to explosive atmospheres in the Machinery Directive. For other relevant risks concerning machines, the requirements of the Machinery Directive also have to be applied.

See also section [§ 34](#) on place of intended use.

§ 234 Transport of Dangerous Goods Directives 2008/68/EC and 98/91/EC (ADR)

In order to avoid possible overlapping with [Directive 2008/68/EC](#) and [Directive 98/91/EC on Transport of Dangerous Goods](#), most means of transport have been excluded from the scope of Directive 2014/34/EU (Article 1(2)(f)). Generally, those vehicles still included in Directive 2014/34/EU do not leave the user's premises. Typical examples are means of transport on rails used in "gassy" mines, forklift trucks and other mobile machinery where the internal combustion engine, braking systems and electrical circuits may be potential sources of ignition.

It is possible for both Directives to be applied in parallel. For example, where the manufacturer designs and constructs a means of transportation intended for transporting dangerous (in this case flammable) goods on public roads as well as for use in areas where explosive atmospheres may exist.

The criteria for application of Directive 2014/34/EU are that the vehicle would need to:

- be defined as an equipment, a protective system or safety device according to Article 1(1) of the Directive;
- have its own potential source of ignition;
- be intended for use in a potentially explosive atmosphere (unless it is a safety device as defined under Article 1(1)(b) of Directive 2014/34/EU).

In order to determine under which intended conditions both Directives will apply the exclusion at Article 1(2)(f) of Directive 2014/34/EU needs to be considered.

This exclusion explicitly determines that "means of transport" except those "intended for use in a potentially explosive atmosphere shall not be excluded".

The definition of "means of transport" is given further detail at Article 2 of Directive 98/91/EC and, in broad terms, is interpreted to be an activity on a public highway or space including unloading and loading operations.

The ATEX Committee therefore considered that, as described in the Commission guidance, a vehicle under the scope of Directive 98/91/EC might also be covered by the ATEX Directive 2014/34/EU.

Where such a vehicle is intended for use in a potentially explosive atmosphere both Directives will apply. However, this does not include where such environments are likely to occur solely as a result of loading and unloading operations as described in 98/91/EC. An example of this is a road tanker transporting petrol when the loading/unloading site is such that it is not initially considered to have a potentially explosive atmosphere because of its location with respect to the storage facility. As noted above, if this environment becomes potentially explosive because of the loading/unloading operation, only the requirements of Directive 98/91/EC need be applied.

In addition, it was agreed that the conformity assessment and technical requirements of 2008/68/EC as further defined by 98/91/EC may not fully align with those required for compliance to Directive 2014/34/EU.

In this context the question arose whether manufacturers of internal monitoring or other devices attached to or inside a vehicle such as a petrol tanker have to apply the ATEX Directive 2014/34/EU and to affix CE marking. The following has been concluded:

1. Based on Article 75 of the EC Treaty (currently Article 95 of the [Treaty on the Functioning of the European Union \(TFEU\)](#)) and transposing the ADR, Directive 2008/68/EC fully harmonises rules for the safe transport of dangerous goods by road.

2. Additionally, based on Article 95 of the EC Treaty (currently Article 114 TFEU), Directive 98/91/EC provides for full harmonisation regarding technical requirements for the following categories of vehicles intended for the transport of dangerous goods by road as follows:

- Category N: Motor vehicles having at least four wheels when the maximum weight exceeds 3.75 metric tons, or having three wheels when the maximum weight exceeds 1 metric ton, and used for the carriage of goods.
- Category O: Trailers (including semi-trailers).

According to Article 4, if the requirements of the Annexes of this Directive are fulfilled for the completed vehicle, Member States may not refuse to grant EU-type approval or to grant national-type approval, or prohibit the registration, sale or entry into service of those vehicles on grounds relating to the transport of dangerous goods.

3. Directive 98/91/EC contains, by reference to Directive 2008/68/EC, requirements covering both electrical (e.g. wiring, batteries) and non-electrical equipment (e.g. heat protection of engine, combustion heaters) of vehicles designed for the carriage of dangerous goods, which may contribute towards the formation of explosive atmospheres.

4. Provided that:

- Such vehicles are not intended for use in a potentially explosive atmosphere other than that caused temporarily by loading or unloading.
- The goods, which shall be transported, are substances and articles as defined in Article 2 of Directive 2008/68/EC.
- The exemptions of Annex A, paragraph 1.1.3, of Directive 2008/68/EC and the ADR agreement are not pertinent.

Under these circumstances the exclusion at Article 1(2)(f) of Directive 2014/34/EU applies to the WHOLE of the vehicle including ALL associated equipment necessary for the carriage of dangerous goods (e.g. "breather valves" of manhole covers, vehicle tracking systems).

In all other cases, the ATEX Directive 2014/34/EU may apply.

Note 1: At some sites tankers may have to access a zone (e.g. zone 1). In this case users responsible for that site may demand the supplier to use tankers with ATEX compliant products.

Note 2: Even if the vehicle or parts of it are intended to be permanently used in a potentially explosive atmosphere, devices like "breather valves" of manhole covers normally would not fall within the scope of Directive 2014/34/EU. Normally these devices have no own ignition source, are no safety devices in the sense of ATEX and are normally not provided with a protective system, such as a flame arrester.

§ 235 Personal Protective Equipment Directive 89/686/EEC (PPE)

The equipment covered by the **Personal Protective Equipment (PPE) Directive 89/686/EEC** is specifically excluded from Directive 2014/34/EU. However, the manufacture of PPE for use in explosive atmospheres is covered by basic health and safety requirement 2.6 in Annex II to the PPE Directive. PPE intended for use in explosive atmospheres must be so designed and manufactured that it cannot be the source of an electric, electrostatic or impact-induced arc or spark likely to cause an explosive mixture to ignite. Following the EHSRs in Directive 2014/34/EU is one way to demonstrate compliance.

Note: the PPE [Regulation \(EU\) 2016/425](#) was published on the OJEU L 81 on 31 March 2016, repealing Directive 89/686/EEC as of 21 April 2018. The Regulation provides for a transition period until 20 April 2019 when personal protective equipment in conformity with the Directive can be still placed on the market.

§ 236 Pressure Equipment Directive 2014/68/EU (PED) and Simple Pressure Vessels Directive 2014/29/EU (SPVD)

The **Pressure Equipment Directive 2014/68/EU (PED)** is a single market directive similar to Directive 2014/34/EU. There are a small number of examples of safety accessories which may be autonomous protective systems or, possibly, equipment. Flame arresters have been judged to be also pressure accessories in the sense of the PED if they are intended to be used with a pressure > 0,5 bar. There are no

additional requirements for the flame arrester element under the PED. PED specifically excludes from its own scope equipment classified no higher than Category I under Article 13 of PED; such kind of product may be inside the scope of ATEX.

The Pressure Equipment Directive deals only with the pressure hazard and does not consider the prevention of and protection against explosions/inflammations, which are not triggered by pressure. It is presumed that PED equipment does not have an own ignition; its safety accessories when used in an explosive atmosphere must comply with the ATEX directive. If such kind of equipment is fully certified in accordance with the directive 2014/34/EU it must be properly installed according to the instructions of the manufacturer (including information about maintenance and repair of the connecting devices, e.g. valves, flanges). If PED equipment shows hot surfaces occurring during operation caused by the temperature of its content solely, it is not applicable to consider this equipment under the ATEX Directive 2014/34/EU. Risk assessment related to hot surfaces and electrostatic charges, among other possible risks, shall be undertaken by the end user to ensure that any explosive atmosphere is not ignited.

The Pressure Equipment Directive 2014/68/EU, replacing the previous Directive 97/23/EC, is applicable from 19 July 2016.

On the other hand, the **Simple Pressure Vessel Directive 2014/29/EU (SPVD)** applies to a limited range of equipment for holding air or nitrogen under pressure. ATEX equipment may incorporate a simple pressure vessel in an assembly, but it is considered that there are relatively few occasions when both Directives will apply to the same product.

The Simple Pressure Vessels Directive 2014/29/EU, replacing the previous Directive 2009/105/EC, is applicable from 20 April 2016.

§ 237 Radio Equipment Directive 2014/53/EU (RED)

The **Radio Equipment Directive 2014/53/EU (RED)** is a New Approach Directive, aligned to the New Legislative Framework, which ensures a single market for radio equipment by setting essential requirements for safety and health, electromagnetic compatibility and the efficient use of the radio spectrum: this applies to all products using the radio frequency spectrum.

Directive 2014/53/EU is applicable from 13 June 2016 and it is the result of the revision of the previous Radio and Telecommunication Terminal Equipment Directive 1999/5/EC.

Equipment in the scope of RED have to comply with the essential health and safety requirements of the ATEX Directive 2014/34/EU when intended to be used in potentially explosive atmospheres, making reference in particular to their "electrical" characteristics, to prevent any potential ignition points by sparks or similar (see also section [§ 255](#) on Wi-Fi access points, and the "[Borderline list - ATEX products](#)").

A point to provide guidance on non-radio products functioning with radio equipment, with different aspects potentially of interest also for ATEX related to risk assessment,

EU declaration of conformity, CE marking etc., is currently under discussion at the relevant working parties under the Radio Equipment Directive.

§ 238 Gas Appliances Directive 2009/142/EC (GAD)

The Directive [2009/142/EC](#) on appliances burning gaseous fuels, or **Gas Appliances Directive (GAD)**, applies to equipment for domestic and non-commercial use but does not apply to equipment designed for industrial processes. Most equipment within scope of GAD is capable of igniting a surrounding explosive atmosphere and cannot comply with ATEX.

It should also be noted the exclusion contained in Article 1(2)(c)) of Directive 2014/34/EU regarding "accidental leak of fuel gas".

The question has been raised as to whether this implicitly conveys the meaning that such equipment, where the leakage is not fuel gas, are included in the scope of the ATEX Directive. It was agreed that, as a general rule, such types of equipment are excluded from the Directive as they are not intended for use in a potentially explosive atmosphere.

Note: the [Regulation \(EU\) 2016/426](#) on appliances burning gaseous fuels, or Gas Appliances Regulation (GAR); was published on the OJEU L 81 on 31 March 2016, repealing Directive 2009/142/EC as of 21 April 2018.

§ 239 Construction Products Regulation (EU) No 305/2011 (CPR)

The **Construction Products Regulation (EU) No 305/2011 (CPR)** replaced the Construction Product Directive 89/106/EEC as by 1 July 2013. Concerning the relationship with the ATEX Directive 2014/34/EU, it was identified that (in a few areas) the scopes of both legislations could overlap. The areas already identified where:

- explosion protection systems and fire suppression systems using the same media;
- both areas are using common hardware for distribution systems such as pipes, pipe hangers, nozzles, etc.

In general, it can be stated that in cases of doubt the Construction Products Regulation is applicable if the subject under discussion is fixed to a building and becomes then a part of the building or if it can be seen as a building itself (e.g. a silo). In such instances the CPR and the ATEX Directive 2014/34/EU apply in parallel. Compliance with the EHSRs of Directive 2014/34/EU will in general show compliance with the EHSRs of the CPR regarding ignition hazards.

§ 240 Marine Equipment Directive 2014/90/EU (MED)

The **Marine Equipment Directive 2014/90/EU (MED)** is not a "New Approach" Directive, as it is based on the principles of the "Global Approach" and does not provide for CE marking (instead, it provides for "the wheel mark"). The ATEX Directive 2014/34/EU specifically excludes from its scope "seagoing vessels and mobile offshore units together with equipment on board such vessels or units", and equipment for use on board a ship is subject only to the MED directive, excluding all others. Nevertheless, the constructional requirements for explosion-protected equipment at sea are generally the same as onshore: this is illustrated by the

reference of the MED to the same or very similar standards, as harmonised under the ATEX Directive. In fact, certain products (such as gas detection equipment) are used offshore and onshore, thus requiring certification per the ATEX Directive and/or by the MED, according to their intended use.

The Marine Equipment Directive 2014/90/EU, replacing the previous Directive 96/98/EC, is applicable from 18 September 2016.

APPLICATION OF DIRECTIVE 2014/34/EU TO SPECIFIC EQUIPMENT

As already indicated (see [section § 32](#)), in some specific circumstances clarification is needed, in order to decide whether a certain product falls within the scope of Directive 2014/34/EU or not. This will be clarified using different examples concerning the application of the ATEX Directive to specific equipment, on the basis of "Consideration Papers" and other guidance documents discussed and approved by the ATEX Committee.

Also, the "[Borderline list - ATEX products](#)" is useful to clarify the situation of a number of products (equipment, protective systems, components, safety controlling or regulating devices, and others) with respect to the ATEX Directive 2014/34/EU.

§ 241 Inerting systems

When looking for the application of Directive 2014/34/EU to inerting systems one has to consider three different cases:

a) Preventing an explosive atmosphere

Inerting systems are aimed at reducing or completely preventing the existence of an explosive atmosphere in specific areas. Inerting systems are not, however, intended to stop or restrain incipient explosions; hence they are not protective systems within the meaning of Directive 2014/34/EU. The goal of inerting systems is different from those of explosion suppression systems, which may sometimes have similar parts, but are aimed at restraining an incipient explosion.

In broad terms: inerting systems used during operation of plants etc. are normally not in scope of Directive 2014/34/EU.

Example: The intended effect of an inerting system applied to inert a tank can only be assessed after knowing all operational parameters of the volume to be inerted. This assessment and the functional aspects of such systems are not covered by Directive 2014/34/EU but a duty to be considered by the user and has to be laid down e.g. in the explosion protection document under the scope of [Directive 1999/92/EC](#) and its national transpositions.

b) Inerting systems as equipment

An inerting system may (in part) also consist of parts which are intended for use within an explosive atmosphere and which have a potential ignition source of their own. These parts come – individually or possibly combined – under the scope of Directive 2014/34/EU as "equipment". Also in this case their function of preventing an explosive atmosphere by inerting is not to be assessed within the meaning of this Directive.

c) Inerting system as part of the ignition protection concept

In some cases, such systems may be part of the ignition protection concept of "explosion protected" equipment to fulfil the requirements of Annex II to Directive 2014/34/EU, i.e. if they work as a means to protect potential ignition sources of the

equipment from coming into contact with an existing potentially explosive atmosphere. This equipment, including its inerting system, comes as part of the equipment under the scope of Directive 2014/34/EU. This inerting system is not a protective system according to Article 1(1)(a). Its parts may be safety, controlling and regulating devices according to Article 1(1)(b) of Directive 2014/34/EU when separately placed on the market.

In broad terms: Directive 2014/34/EU applies to an inerting system, if this system is – or is intended to be – integrated into the ignition protection concept of the equipment and thus serves to avoid ignition sources of the equipment.

Example: Where the manufacturer of equipment intended for use in potentially explosive atmosphere wants to protect the ignition sources of this equipment, he may use the type of protection "pressurisation" according to EN 60079-2⁴⁴. This type of protection may include the use of inert gases as protective gases. In this case the inerting system is part of the equipment and as such within the scope of Directive 2014/34/EU. The following case may occur in practice: equipment according to Article 1 of Directive 2014/34/EU contains an enclosure or a vessel containing sources of ignition. In order to prevent an explosive atmosphere from coming into contact with the ignition sources, an inerting system, which has been assessed in accordance with Directive 2014/34/EU as a safety device, can be applied to this equipment.

§ 242 Paint spray booths

These products are an enclosed area, where an operator may work inside or outside, and may be described as a "simple box". The "box", with no ignition source and not intended for use in a potentially explosive atmosphere, does not fall within the scope of the ATEX Directive 2014/34/EU.

Under operating conditions a potentially explosive atmosphere is created and the enclosed area, openings and recovery systems are normally assessed with regard to the explosion risk. The equipment, protective systems and components intended for use in this assessed potentially explosive atmosphere including safety and controlling devices outside, but contributing to their safe functioning, are within the scope of Directive 2014/34/EU.

In summary, paint spray booths, as an integral whole, do not fall under scope of the ATEX Directive 2014/34/EU and as such cannot be affixed with the special marking for explosion protection and other marking detailed at Annex II, EHSR 1.0. of the Directive.

§ 243 Filter units and vented silo bins

The question arises, how should the Directive be applied to filter units and vented silo bins?

Most filters and silo bins will have an explosive dust cloud inside at some point during normal operation.

⁴⁴ EN 60079-2:2007 *Explosive atmospheres - Part 2: Equipment protection by pressurized enclosure 'p'* (IEC 60079-2:2007)

The inside may be areas in which an explosive atmosphere caused by air/dust mixtures are present continuously, for long periods or frequently, or areas in which such an atmosphere is likely to occur, depending on the operating conditions.

Many filters and silos are located in the open air, or in a room in a building which does not need to be classified as hazardous.

With the exception of 5)a) and 7) the description below of different cases assumes that filters and silos themselves will not be a source of dust release that would give rise to a potentially explosive atmosphere in the surrounding area.

This description also considers that many apparatuses with filters inside are fitted with explosion protection devices, such as vent panels, doors or suppression equipment.

1) The filter or the silo bin has no moving parts or electrical equipment on the inside, and is located in a non-hazardous area.

Conclusion: These filters or silos are not in scope of the Directive 2014/34/EU.

Electrostatic hazards may exist from insulating surfaces inside the filter, from the filter elements or from cone discharges in silos. This risk depends for example on the properties of the dust being collected, and other operating conditions. But any electrostatic risks are not considered as giving the filter or silos its own potential source of ignition, so these filters or silos do not fulfil the definition of equipment in Article 1(3)a.

Remark: These filters or silos do not fulfil the other criteria of the definition.

The electrostatic risks can be covered by other directives, for example the Machinery Directive when the filter is part of a machine. In this case the manufacturer of the machine is responsible to avoid this risk according to the provisions of the Machinery [Directive 2006/42/EC](#) (see section [§ 233](#)). In all cases these risks must be controlled by the user under [Directive 1999/92/EC](#). The electrostatic risks are covered in the standard EN ISO 80079-36 *Non-electrical equipment for explosive atmospheres - Basic method and requirements*.

2) The filter has moving parts inside that can be considered as mechanical equipment, such as a bag shaking mechanism, or a screw feeder to remove collected dust. The whole filter is located in a non-hazardous area.

Conclusion: The manufacturer must assess whether the moving parts create its own potential source of ignition. If the moving parts do not create any potential source of ignition, perhaps because they have low power, or move very slowly, the situation is the same as case 1, and the filter is not in scope of the Directive.

Remark: Low power in this sense is not given, when for example the power source is strong and only the power inside the equipment is reduced by protection methods in order to avoid an ignition risk. There is a similar situation in case of the electrical type of protection the "intrinsic safety".

If the mechanical equipment on the inside does create an ignition risk, this equipment (as part of the complete apparatus) must comply with the ATEX Directive 2014/34/EU (see section [§ 34](#) on place of intended use).

If inside the filter an explosive atmosphere caused by air/dust mixtures is present continuously, for long periods or frequently, according to Annex I for the equipment inside, conformity with category 1 should be reached. But this will in respect of the state of the art not always be possible. In these cases according to:

- Annex II A, technological knowledge must be taken into account, and
- Annex II 1.0.1, the principles of integrated explosion safety must be applied.

That means when it is not possible to prevent the ignition source sufficiently – according to the "state of the art" – to reach category 1, category 2 can be sufficient when the manufacturer takes additional measures "to halt it immediately and/or to limit the range of explosion flames and explosion pressures to a sufficient level of safety" (see Annex II 1.0.1 indent 3). It is in the responsibility of the manufacturer to take this decision.

The explosion vent can be seen as an example of integrated explosion safety as described under Annex II 1.0.1.

In this case, and if the complete apparatus (filter with explosion vent panel or doors) is produced and integrated by the same manufacturer, not only the mechanical but all equipment inside falls under the scope of Directive 2014/34/EU. Consequently the manufacturer takes the following measures:

- preventing sufficiently the ignition source inside (according to the "state of the art");
- selecting an appropriate protective system in order to limit the range of explosion flames and pressure;
- designing the filter in such a way that it can withstand an internal explosion without rupturing (design for the reduced explosion pressure in conjunction with explosion pressure relief or explosion suppression).

3) The complete filter or the silo bin has electrical equipment inside. In filters those electrical equipment may be a pressure switch, or level switch on the container that collects the dust, in silos level indicators are widely used.

Conclusion: This electrical equipment is equipment in the sense of Article 1.1 of the Directive 2014/34/EU and therefore must comply with this Directive.

4) The silo bin or the complete apparatus with the filter is fitted by the manufacturer with explosion vent panels or doors, supplied by another manufacturer.

Conclusion: These panels or doors are 'protective systems' in the sense of the Directive 2014/34/EU and the manufacturer of these systems has to apply the directive when placing this as an autonomous system on the market. That means the procedure set out in Article 13(2) has to be applied and they must be CE and Ex marked. Selecting the correct panel or door (for example: size, quality, function) depends on the application and has to be done by the manufacturer of the apparatus.

5) The silo bin or the complete apparatus with the filter is fitted with explosion vent panels or doors produced and integrated into the filter or silo by the filter/silo manufacturer themselves.

Conclusion:

For filters we have to distinguish two cases:

- a) The complete apparatus is in the scope of the Directive 2014/34/EU.
- b) The complete apparatus is not in the scope of the Directive 2014/34/EU.

For silos, generally case b) is applicable.

Case a)

These are not autonomous protective systems according to Article 2(2) because they are placed on the market as a part of an equipment in the sense of Article 1(1) and not separately. Therefore Article 13(2) has not to be applied. The protective system alone is not in the scope of the Directive but the whole equipment. That means the conformity procedure of the equipment includes the protective system.

However, if another manufacturer sells complete replacement vent panels or doors as spare parts, these are autonomous protective systems, separately placed on the market and then he must apply the Directive 2014/34/EU. That means they must for example be tested, CE and Ex marked in the same way as complete panels or doors separately placed on the market from other manufacturers.

Case b)

These complete apparatus or explosion vent panels or doors are autonomous protective systems according to Article 2(2) because they are separately placed on the market in the sense of the directive and therefore Article 13(2) has to be applied. That is because they are not placed on the market as a part of an equipment in the sense of Article 1(1).

Remark for filters: In case 4 or 5, the manufacturer in any case carries responsibility for ensuring that the body of the filter will not fail in the event of an explosion, even though it is not covered by specific EU legislation. Users should ask the manufacturers how they can be sure that the filter complies with the safety requirements of the Work Equipment Directive 2009/104/EC (that repealed the Directive 89/655/EC amended by 95/63/EC and 2001/45/EC); especially Annex I, 2.7.

Remark for silos: Even protective systems such as vent areas which are integrated in the cell ceiling of silos or inserted lightweight constructions are protective systems for the purpose of Directive 2014/34/EU and must be placed separately on the market as autonomous protective systems and must therefore be treated as such with regard to assessment of conformity and marking.

6) A – normally small – apparatus with only a filter sock, plastic collection bag and fan, but no metal enclosure.

Conclusion: If during the intended use a dangerous explosion pressure cannot be formed in such a small apparatus when a dust cloud inside the filter is ignited, the inside is not to be classified as a hazardous area and the equipment used inside is not in the scope of the Directive 2014/34/EU.

This is the case with some filters used for collecting wood dust and wood-waste.

7) The silo or an apparatus with a filter is intended to be installed in an area, in which air/dust mixtures are unlikely to occur or, if they do occur, are likely to do so only infrequently and for a short period only.

Conclusion: In respect of the complete apparatus the Directive 2014/34/EU is only relevant for the manufacturer, if it is equipment in the sense of this Directive. To find out if the whole apparatus is such equipment, the manufacturer of this apparatus for example must examine if it creates any possible sources of ignition, which can ignite an explosive atmosphere on the outside. When this can happen, he has to apply the Directive 2014/34/EU.

The apparatus must in this case conform to category 3.

Remark: Equipment of this type may be needed if there are for example sources of dust release from other equipment nearby.

As silos have no own possible ignition source, which can ignite an explosive atmosphere on the outside, they will not conform to category 3.

General remark for autonomous protective systems:

Measures for the indirect explosion pressure venting at buildings, like for example windows, walls of lightweight construction or similar, do not fall within the scope of Directive 2014/34/EU. The employer/operator himself is responsible to implement such measures. In doing so, priority shall be given to the requirements according to the building regulations.

§ 244 Gas turbines

1. It was accepted by all concerned that:

- Gas turbines on their own are not normally placed on the market as a single functional unit but are generally incorporated with other machinery before they can function, and will only function as intended once they are properly installed.
- Since 30 June 2003, manufacturers and users of gas turbines need to comply, in addition to the Machinery Directive, as appropriate with the requirements of both ATEX Directives 94/9/EC (since 20 April 2016, 2014/34/EU) and [1999/92/EC](#) respectively – relating to design and manufacture of such equipment and the health and safety of workers potentially at risk of explosive atmospheres.
- Gas turbine fuel supplies may give rise to a potentially explosive atmosphere in the vicinity of the turbine. Additionally, other sources of a potentially explosive atmosphere may also exist, e.g. lubricating oils. Equipment in category 3 of equipment-group II would usually be required in such areas.
- In normal circumstances, a gas turbine could have hot surfaces above the auto ignition temperature of the fluids used. Operation under fault conditions may increase surface temperatures.

- A gas turbine which has surface temperatures that can lead to the ignition of a potentially explosive atmosphere cannot comply with the relevant provisions of Directive 2014/34/EU. In such circumstances additional measures are required.

2. It should be noted that in all instances of the following guidance the general concepts described for "Place of intended use" (see section § 34) and for "Interface to different potentially explosive atmospheres" (see section § 35) will apply (e.g. ATEX compliant equipment must be used, where applicable, inside machinery).

- Although manufacturers must, to the state of the art, eliminate or control sources of ignition, it may not be technically possible to reduce the temperature of all hot surfaces to comply with the essential health and safety requirements of the ATEX Directive 2014/34/EU⁴⁵.

- A number of alternatives are available for selection as a basis for safety, e.g. limitation of the volume of the explosive atmosphere by dilution ventilation⁴⁶, explosion relief, explosion suppression or a combination of these techniques.

- A supplier (this may be the turbine manufacturer, packager, installer, final supplier, etc. and in some cases the end user) delivering gas turbine machinery and associated safety devices is responsible for risk assessment and implementation of the chosen basis of safety under Directive 2014/34/EU. Irrespective of the chosen basis of safety there is the potential for an explosive atmosphere to arise near the turbine, and proper consideration should be given to minimising the risk of ignition. The supplier as described above is also responsible for the communication of instructions for safe use and any residual risk to the end user sufficient for the completion of risk assessments under the relevant workplace directives.

- Interested parties should consider the provisions of the ATEX Directive 2014/34/EU and guidance documents with further information on the relevant responsibilities.

3. A gas turbine as a complete machine the ignition sources of which have no interface to a potentially explosive atmosphere outside the enclosure does, however, not fall under scope of the ATEX Directive 2014/34/EU and as such cannot be affixed with the special marking for explosion protection and other marking detailed at Annex II, EHSR 1.0.5. of the Directive.

4. Intended to be used in a potentially explosive atmosphere.

§ 245 Steam turbines

1. It was accepted by all concerned that:

- Steam turbines on their own are not normally placed on the market as a single functional unit but are generally incorporated with other machinery before they can function, and will only function as intended once they are properly installed.

⁴⁵ Annex II, EHSR 1.3.1 "Potential ignition sources such as ..., high surface temperatures, ... must not occur".

⁴⁶ Dilution ventilation reduces the size of any flammable cloud to below that which would result in a hazardous explosion if ignited. In order that the dilution ventilation ensures a negligible risk of an explosive atmosphere at all times, the ventilation system should have additional safety features such as e.g.: a 100% standby fan; an uninterruptible power supply to the ventilation fans; interlocks so that the gas turbine cannot start without sufficient ventilation; proven automatic isolation of fuel supply if ventilation fails.

- Since 30 June 2003, manufacturers and users of steam turbines placed in a potentially explosive atmosphere need to comply, in addition to the Machinery Directive, as appropriate with the requirements of both ATEX Directives 94/9/EC (since 20 April 2016, 2014/34/EU) and [1999/92/EC](#) respectively – relating to design and manufacture of such equipment and the health and safety of workers potentially at risk of explosive atmospheres.

- Steam turbines cannot give rise to a potentially explosive atmosphere by themselves but may be installed in a potentially explosive atmosphere originating from external sources (e.g. when gaseous hydrogen used as a turbo-generator coolant, being released and mixed with the air, contributes to classification of zone around the turbine).

- In normal circumstances, a steam turbine could have hot surfaces above the auto ignition temperature of the external potentially explosive atmosphere. The surface temperatures depend on the temperature of incoming steam which is supplied by an external source such as a boiler.

- A steam turbine which has surface temperatures that can lead to the ignition of a potentially explosive atmosphere cannot comply with the relevant provisions of Directive 2014/34/EU. In such circumstances additional measures are required.

2. Given the above, the obligations of the manufacturer and user of steam turbines need to be considered. It should be noted that in all instances of the following guidance the general concepts described for "Place of intended use" (see [section § 34](#)) and for "Interface to different potentially explosive atmospheres" (see [section § 35](#)) will apply (e.g. ATEX compliant equipment must be used, where applicable, inside machinery).

- The manufacturer can ATEX certify the steam turbine for use in external potentially explosive atmospheres with auto ignition temperatures above the specified maximum steam inlet temperature.

- Although manufacturers must, to the state of the art, eliminate or control sources of ignition, it may not be technically possible to reduce the temperature of all hot surfaces to comply with the essential health and safety requirements of the ATEX Directive 2014/34/EU⁴⁷.

- The main measure for safety is to prevent the explosive atmosphere from being in contact with the hot surfaces of the steam turbine, e.g. by an over-pressurised enclosure.

- A supplier (this may be the turbine manufacturer, packager, installer, final supplier, etc. and in some cases the end user) delivering steam turbine machinery and associated safety devices is responsible for risk assessment and implementation of the chosen basis of safety under Directive 2014/34/EU. Irrespective of the chosen basis of safety if there is the potential for an explosive atmosphere to arise near the turbine, and proper consideration should be given to minimising the risk of ignition. The supplier as described above is also responsible for the communication of instructions for safe use and any residual risk to the end user sufficient for the completion of risk assessments under the relevant workplace directives.

- Interested parties should consider the provisions of the ATEX Directive 2014/34/EU and guidance documents with further information on the relevant responsibilities.

⁴⁷ Annex II, EHSR 1.3.1 "Potential ignition sources such as ..., high surface temperatures, ... must not occur".

3. In full application of the above guidance, a steam turbine as a complete machine the ignition sources of which have no interface to a potentially explosive atmosphere outside the enclosure does, however, not fall under scope of the ATEX Directive 2014/34/EU and as such cannot be affixed with the special marking for explosion protection and other marking detailed at Annex II, EHSR 1.0.5. of the Directive.

4. It is evident that a steam turbine, delivered as a complete machine by one supplier, is considered to be an assembly in the sense of Directive 2014/34/EU and shall be marked accordingly, if it is intended to be used in a potentially explosive atmosphere.

§ 246 Petrol pumps

Whilst categorisation of equipment was always the sole responsibility of the manufacturer, the view of the majority of the ATEX Committee considered that, under normal circumstances, petrol pumps may be suitably categorised as category 2.

Given this, and the fact that the assembly is sufficiently complicated and includes an electrical motor – with an additional ignition hazard as a result of assembling pump and motor –, the majority of the members concluded that notified body intervention with respect to the completed assembly was required, in line with the complete conformity assessment procedures outlined in the ATEX Directive 2014/34/EU (Annex III: EU-type examination).

See also section [§ 44](#) on combined equipment (assemblies), point 2. c).

§ 247 Cables

The question arises, should cables be marked according to the ATEX Directive?

Cables are not covered by the product-related ATEX Directive (neither as equipment neither as components) because in most cases they fall into the field of installations, and as such, cables have never been regarded as an ignition source of considerable risk in hazardous areas if protected properly in a mechanical and electrical manner.

Furthermore and with a view to the extreme variety of possible situations of application in equipment devices in the scope of Directive 2014/34/EU, a reliable and serious list of ATEX-conforming cables seems not to be practicable. End-users and installers may choose cables according to the state of the art and according to the requirements of the Low Voltage Directive 2014/35/EU. Cables conforming to the latter Directive are considered to be adequate for use in products falling under the scope of Directive 2014/34/EU.

Consequently, cables should bear no marking according to the ATEX Directive 2014/34/EU.

§ 248 Rotating mechanical seals

The question arises, when a Mechanical Seal⁴⁸ is a Machinery element and when an ATEX component?

⁴⁸ This section does not consider mechanical seal control systems.

Definition: A mechanical seal is a device which prevents leakage of fluids along rotating shafts. Primary seal function is at right angles to the axis of rotation between one stationary ring and one rotating ring.

Machinery element: These are parts of Machinery not defined within Directive 2014/34/EU.

Most mechanical seals are machinery elements. Typically these seals are:

- Catalogue mechanical seals and their parts, selected by the equipment manufacturer alone or with assistance from the mechanical seal manufacturer.
- Mechanical seals stocked by the equipment manufacturer or end user for general applications
- Mechanical seals used for applications where the service conditions are not closely specified
- Non cartridge-seals and parts.
- Standard cartridge-seals.

Mechanical seals will also be machinery elements if a risk assessment by the mechanical seal or equipment manufacturer shows that the seal is not expected to be an ignition source even in the event of fault conditions.

ATEX component:

The two defining elements for components are that they,

- are essential to the safe functioning of equipment and protective systems with respect to explosion protection (otherwise they would not need to be subject to the Directive);
- with no autonomous function (otherwise they would have to be regarded either as equipment, protective system or as device according to Article 1).

Engineered mechanical seals maybe classified and sold as ATEX components. Typical examples are:

- Mechanical seals for specific applications where close co-operation between mechanical seal manufacturer and equipment manufacturer is required and will often result in a specifically designed mechanical seal.
- Mechanical seals for some category 1 equipment.

In this case the mechanical seal manufacturer shall supply sufficient information about the performance of the seal so that the equipment manufacturer does not need to repeat unnecessary efforts such as tests or calculations concerning the mechanical seal in order to ensure that the equipment complies with ATEX requirements. The equipment manufacturer shall supply sufficient information about the intended application and equipment.

Responsibilities:

A) Mechanical seal manufacturer:

Case 1: Mechanical seals supplied as Machinery elements

It is normal practice that the manufacturer of mechanical seals supplied as Machinery elements provides complete documentation for safe use of his product, i.e.: instruction manual for incorporation into equipment, which shall include safety aspects and limits of operation.

Case 2: Mechanical seals supplied as ATEX components

Mechanical seals shall comply with Article 13(3) of the ATEX Directive 2014/34/EU.

An ATEX-component mechanical seal shall be supplied at least with the following information:

- all information/documentation given for case 1
- results of relevant calculations and/or tests that have been carried out
- a temperature rating as far as possible
- an indication of the category
- a list of ATEX essential safety requirements that the mechanical seal complies with
- what fault conditions have been considered for category 1 or 2 mechanical seal
- a close specification for intended use, for example gas group
- a certificate of conformity
- marking for components in accordance with the Directive.

B) Equipment Manufacturer:

In all cases the equipment manufacturer is responsible for the entire package within his scope of supply and therefore it will be required to comply with Article 13(1) of the ATEX Directive 2014/34/EU.

§ 249 *Bucket elevators*

The question arises, how are bucket elevators to be treated within the framework of Directive 2014/34/EU especially in respect that in the surrounding area of bucket elevators potentially explosive areas are not necessarily present?

The intention of Directive 2014/34/EU is to avoid the ignition of potentially explosive atmospheres by equipment, protective systems and components. According to the potential hazards and the prevention measures the products are divided into categories.

Directive 2014/34/EU defines a potentially explosive atmosphere as an atmosphere, which could become explosive due to local and operational conditions. This means that the potentially explosive atmosphere is either present from the beginning or develops during the working process (e.g. in relation with the conversion of energy or the processing of materials).

In bucket elevators the potentially explosive area is limited in general by housings and/or sheathings, whereby a multiplicity of potential ignition sources can become effective due to construction, for example by rubbing and flapping sparks or by inadmissible heating.

An ignition hazard assessment should be carried out by the manufacturer of bucket elevators to analyse all the equipment related potential ignition sources able to ignite an explosive atmosphere (e.g. belts, buckets, angle wheels, drive units, regulating

devices - see also EN 1127-1 for the list of ignition source) and take all preventive measures according to design, transported material, transport speed etc. under the aspect of the intended use of the equipment.

The necessary level of protection of equipment and components inside the housing (e.g. category) depends on the frequency and the occurrence of the explosive atmosphere inside this housing.

According to the necessary level of safety, depending on their incorporation in the housing and the disturbances or equipment faults, which have normally to be taken into account, some components (presenting a higher risk) might be assigned to categories different to the entire category of the bucket elevator. The document CEN/TR 16829:2016 prepared by Technical Committee CEN/TC 305 deals with bucket elevators that may handle combustible products capable of producing potentially explosive atmospheres of dust or powder inside the bucket elevator during its operation.

Zone (responsibility of the end-user)		Probability of occurrence of explosive atmosphere		Category
Inside the bucket elevator	Outside the bucket elevator	Inside the bucket elevator	Outside the bucket elevator	
20	-	for long periods or frequently	-	II 1 D/-
20	21	for long periods or frequently	21 occasionally	II 1/2 D
21	22	occasionally	unfrequently or for a short period	II 2 D
21	22	occasionally	unfrequently or for a short period	II 2/3 D
22	22	unfrequently or for a short period	unfrequently or for a short period	II 3 D
22	-	unfrequently or for a short period	-	II 3/- D

If some ignition sources cannot be avoided by the design of equipment or components, the manufacturer of the bucket elevator has to avoid the transmission of explosion to all the process.

The user/employer normally selects a bucket elevator based upon the category (related to internal zone) and then shall perform a risk assessment based upon the local circumstances. Such a risk analysis shall include the probability that ignition sources enter from outside but also the potential consequences of an explosion. Depending upon the acceptability of risks, in addition to preventative measures (based upon category of the bucket elevator) explosion protection measures may be needed.

The ATEX 'workplace' Directive 1999/92/EC, which deals with the minimum requirements for improving the level of health and safety protection of workers potentially at risk from explosive atmospheres, complements the responsibilities of

manufacturers under Directive 2014/34/EU by setting out the responsibilities of user/employers.

§ 250 Fork lift trucks

Note: This section is currently under revision.

Fork lift trucks intended to be placed on the EU market for use in a potentially explosive atmosphere are considered combined equipment or assemblies (see [section § 44](#)). They must also, where relevant, comply with other applicable directives (e.g. the Machinery [Directive 2006/42/EC](#) – see [section § 233](#), the Electromagnetic Compatibility [Directive 2014/30/EU](#) – see [section § 231](#), etc.).

A fork lift truck, which complies with all applicable directives, must be placed on the market by a single responsible person. More than one CE marking, EU declaration of conformity, etc. makes it unclear who is responsible for the compliance of the final product and is not acceptable.

The responsible person must have the means to show that there is full compliance with all applicable Directives, also those dealt with by possible subcontractors.

Selection of the conformity assessment procedures

The conformity assessment procedure according to Directive 2014/34/EU depends on the category of the product. In the all well-known cases explosion-proof fork-lift-trucks are to be assigned to the categories 2 or 3.

Fork lift trucks can be regarded for the selection of the conformity assessment procedure as combined equipment which if necessary contains an internal combustion engine, as well as different electrical and non-electric devices.

Fork lift trucks category 2:

- Internal combustion engines and the electrical equipment must be submitted to the conformity assessment procedure in accordance with Article 13(1)(b)(i) of Directive 2014/34/EU; for both, the procedure of the conformity assessment procedure according to the Article 13(1)(b)(i) is to be accomplished by a notified body in any case.
- The manufacturer has to ascertain that there are no additional ignition risks due to the combination of electrical equipment. This means for example a change of the temperature class. Usually the combination of components (EU-type examination certificate of components) does not fulfil these requirements.
- The combined equipment (fork-lift truck) is neither electrical equipment nor another internal combustion engine, therefore Article 13(1)(b)(ii) of Directive 2014/34/EU applies to the conformity assessment procedure for the category 2: The manufacturer must use the internal production control in accordance with Annex VIII (including design and production) and deposit the technical documentation with a notified body in accordance with Article 13(1)(b)(ii); the notified body has to confirm the receipt of these documents immediately.

Fork lift trucks category 3:

For category 3 the manufacturer must use the procedure of the internal production control in accordance with Annex VIII to Directive 2014/34/EU.

All fork lift trucks categories:

In all categories, the manufacturer can choose to use the procedure of the unit verification according to Annex IX to Directive 2014/34/EU.

Other Directives applying

The manufacturer has to fulfil the requirements of all Directives appropriate to his product. In particular, the manufacturer has to guarantee that the fork lift truck complies with the essential health and safety requirements of the Machinery Directive 2006/42/EC in the case of conversion to an explosion proof fork lift truck.

EU declaration of conformity

Preferably the manufacturer should draw up a EU declaration of conformity which summarizes the EU declarations of conformity for all Directives applying. Alternatively the EU declaration of conformity according to the Machinery Directive 2006/42/EC and/or the Electromagnetic Compatibility Directive 2014/30/EU can be issued separately.

§ 251 Transportable, pressurised cabins ("modules")

This section deals with the application of the ATEX Directive 2014/34/EU to transportable pressurised cabins (or "modules"), as such products are considered to be in-scope of the Directive.

Cabin description

Such cabins are often intended for use in a zone 1 or zone 2 hazardous area and are used at both onshore and offshore sites (e.g. fixed drilling platforms). The cabins are pressurised with breathable air both to exclude ingress of flammable gas and to provide a safe atmosphere for operators to work inside the cabins.

The cabins are supplied to meet a variety of purposes, e.g. laboratory, control cabin, office or workshop. They are placed on the market in their finished state, ready for use, but "empty" – suitable for the customer to install and use their own equipment inside the cabin.

The design includes the incorporation of a number of ATEX-certified items, such as fire and gas detection systems, automatic shutdown systems and ventilation fans.

The design ensures positive pressure inside the module to prevent the ingress of flammable gas. As long as there is no internal source of release, this allows the enclosed area to be regarded as a non-hazardous area (reference, for example, UK Institute of Petroleum Code IP 15, section 6, 2002).

The cabin interior is often fitted with unprotected electrical fittings such as luminaires, switches and socket outlets. Should the cabin suffer a loss of pressure, these items have the potential to be exposed to an ingress of flammable gas which may form a potentially explosive atmosphere.

Therefore, the cabins are designed with many safety features to prevent this situation, such as smoke and gas detectors and alarms and the automatic shutdown of non-certified electrical equipment being used inside the cabin.

Application of 2014/34/EU

Where a manufacturer assembles and supplies a product which includes a number of ATEX-certified items (as is the case here), they are responsible for assuring that the process of design/ manufacture has not introduced any additional ignition sources or other relevant hazards and for having the assembly ATEX certified.

The ventilation system for these cabins should be viewed as a protection device, from the definitions in the Directive. A pressurisation fan and a long length of ducting are incorporated, so that the fan can be deployed in a remote, safe area. Therefore, the safe operation of the pressurisation system also needs to be assured. The module itself forms the pressurised enclosure and must therefore be subject to conformity assessment, which would need to demonstrate the effective application of the pressurisation concept (including consideration of the safety integrity of the pressurisation control system) so as to meet the essential health and safety requirements of Directive 2014/34/EU.

The European harmonised standard EN 50381:2004 *Transportable ventilated rooms with or without an internal source of release* covers the essential health and safety requirements of Directive 2014/34/EU and applies to the cabins covered in this paper. "Ventilation" in this standard is used as a means of explosion protection ("ventilation" is also being used in these particular modules to ensure adequate air quality for personnel working inside. However, this aspect is out with the scope of the standard).

An alternative route to compliance is for the manufacturer to demonstrate that the essential health and safety requirements of Directive 2014/34/EU have been met. This would include demonstrating the effective application of the pressurisation concept, including consideration of the safety integrity of the pressurisation control system.

It is stated in EN 50381:2004 that it is not the intention of this standard to cover stationary analyser houses according to EN 61285:2004 *Industrial-process control - Safety of analyser houses*.

User's responsibilities

The installation of the cabin in accordance with the manufacturer's instructions is common to many ATEX products and shouldn't require further certification by/for the end user. The only circumstances when the end user would need to undertake ATEX conformity assessment under Directive 2014/34/EU would be if they made any changes which affected the explosion safety features of the product or if they needed

to install it in a manner which was not in accordance with the manufacturer's instructions. These instructions should also state any limitations on the use of (non-protected) equipment inside the cabin.

§ 252 Automatically lubricating systems

Facts of the case:

An automatic lubricant dispenser has a housing, a piston subdividing the housing into a pair of compartments one of which is generally closed and the other of which is adapted to be connected to a machine to be lubricated.

(see the picture below: example of scheme of an automatically lubricating system)

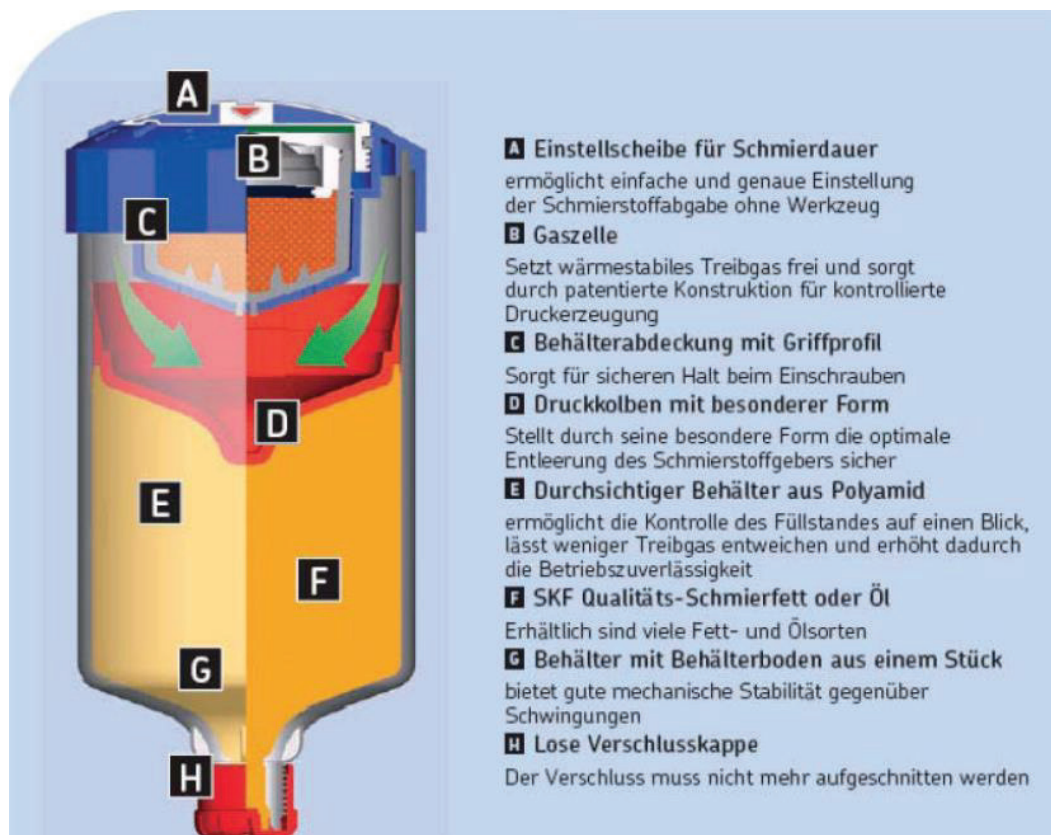

In the closed compartment the plus- minus- poles are in contact with a gel and the production of gas is activated by an electric short circuit. The amount of gas pro time unit will be regulated through an electrical resistance. The greater the resistance, the slower the production of gas. The amount of gas is proportional to the current which flows through the battery. If the supply is interrupted, the gas production will be stopped for a short period of time.

The lubrication systems have one or two electric battery cells. The electric values of the battery cells are above the values specified in EN 60079-11, Chapter 3.11 and 5.7.

The automatic lubrication system is electrical equipment in the sense of the ATEX Directive 2014/34/EU; the battery cells are an integral part of the system.

Annotation: Another possible ignition sources – mechanical or electrostatic – are not to expect.

Discussion:

- *Section § 43:* "electrical equipment can be considered as equipment containing electrical elements, used for the generation, storage, measurement, distribution and conversion of electrical energy, for controlling the function of other equipment by electrical means or for processing materials by the direct application of electrical energy. It should be noted, that a final product assembled using both electrical and mechanical elements may not require assessment as electrical equipment provided the combination does not lead to additional ignition hazards for this assembly".
- *Section § 38:* "for 'simple' electrical products, European harmonised standards provide a good basis to assess the effectiveness of electrical ignition source and, consequently, to determine whether or not these can be considered effective or not".
- *Section § 42:* "Mechanical equipment may be fitted with a thermocouple or similar measuring device that generates only very low voltages and currents. If these measuring devices can be considered as 'simple apparatus' (*as described in section § 38*) and there are no other electrical parts, the equipment should follow the conformity assessment procedures for non-electrical equipment".
- Draft standard prEN 60079-11⁴⁹ (IEC 31/782/CD):
"5.6 Simple apparatus
The following apparatus shall be considered to be simple apparatus:
a) passive components, for example switches, junction boxes, resistors and simple semiconductor devices;
b) sources of stored energy with well-defined parameters, for example capacitors or inductors, whose values shall be considered when determining the overall safety of the system;
c) sources of generated energy, for example thermocouples and photocells, which do not generate more than 1,5 V, 100 mA and 25 mW. Any inductance or capacitance present in these sources of energy shall be considered as in b).
Simple apparatus shall conform to all relevant requirements of this standard but need not be certified and need not comply with clause 12. In particular, the following aspects shall always be considered".

Conclusion:

The batteries are an integral part of the lubrication system, therefore it is to be regarded as an electrical equipment. An EU-type examination certificate for the lubrication system category 2 is necessary.

Remarks:

- There are lubrication systems without a cell; gas is produced by electrochemical reaction. These lubrication systems are neither electrical nor non-electrical equipment.
- The ExNB Group approved the statement to the automatically lubrication systems.

⁴⁹ The currently harmonised standard is EN 60079-11:2012 *Explosive atmospheres - Part 11: Equipment protection by intrinsic safety 'i'*.

§ 253 *Electrical trace heating systems*

Notes:

- This section only applies to electrical trace heating systems which are placed on the market pursuant to Directive 2014/34/EU by a manufacturer as electrical equipment.
- It is not intended to deal with electrical trace heating installations which are designed, installed and approved in accordance with particular national regulations in the Member States.

Conformity assessment of different types of electrical trace heating systems

(1) Electrical trace heating systems⁵⁰ designed for use in potentially explosive atmospheres are electrical equipment pursuant to Directive 2014/34/EU. In many cases certain characteristics, relevant for safe operation, in particular the temperature class, are determined by the design and the installation. Therefore the process of placing on the market has to take on board these special conditions. Consequently it is necessary to apply certain special requirements regarding installation of these products. It is particularly important to specify the responsible person /the manufacturer, the supplier (designer) or the installer) who ensures that the electrical heating system complies with the requirements of Directive 2014/34/EU and therefore takes over the responsibility of a manufacturer. These questions cannot be answered clearly and comprehensively for all electrical trace heating systems, as a differentiation needs to be made between specific designs and techniques.

(2) The measures required for the explosion protection of electrical trace heating systems depend on the category (respective zone classification), the explosion group, and the temperature class involved.

Directive 2014/34/EU does not require category 3 systems to be certified by a notified body. The manufacturer is required to apply the modules as described in Annex VIII (Internal control of production) for conformity assessment. The manufacturer compiles an EU declaration of conformity and the technical documentation that enables assessment of conformity with the requirements of the Directive. Hence, the product shall not have the number of a notified body affixed, unless individual testing pursuant to Annex IX is involved.

Existing industry standards do not address the installation of electrical trace heating systems in zone 0 (category 1), so this will not be examined any further. The following statements apply exclusively to category 2 electrical trace heating systems.

⁵⁰ Trace heating system: the system is mainly externally applied to equipment and used to maintain (or raise) the temperature of contents in piping, tanks, and vessels. A complete trace heating system consists of:

- electrical resistance trace heater unit (heating cable or pads),
- possibly monitored by temperature controllers and/or limiters,
- installation accessories, like terminal enclosures, connectors and splice kits,
- thermal insulation and weather barrier (cladding).

The system also includes the appropriate marking and system documentation (operating manual, design documentation, test certificates, declarations of conformity, etc.).

System components: all of the components necessary for the safe use as intended of an electrical trace heating system. These components must have either separate EU-type examination certificates or they must be included in a heating system certificate.

(3) It should be noted in particular that the existence of EU-type examination certificates which only apply to individual system components of a trace heating system is inadequate. As temperatures may vary, depending on the type of the heating cables and installation conditions involved, each system needs to be examined individually. The applicable EU conformity assessment procedure should be employed to suit the design.

Therefore, the manufacturer of the trace heating system is required to apply one of the possible conformity assessment procedures pursuant to Directive 2014/34/EU for electrical equipment. As regards category 2 these are the following modules:

- Annex III and VI, or
- Annex III and VII, or
- Annex IX.

(4) Different types of trace heating systems⁵¹:

a) "Stabilized Design"

An electrical trace heating system shall be designed so that, even in the event of an anticipated malfunction the surface temperature is limited corresponding to the temperature classification:

- minus 5 K for temperatures less than or equal to 200 °C or
- minus 10 K for temperatures exceeding 200 °C.

Either product (self-regulating heating tape) or system certification (stabilised design achieved through definition of system parameters) shall be applied to the stabilised design. The notified body may issue an EU-type examination certificate on this basis which also includes the temperature class. The manufacturer delivers the trace heating system components with an EU declaration of conformity, instruction manual including design details and a marking plate. The manufacturer may affix the CE marking before the trace heating system is placed on the market.

An electrician with adequate knowledge of explosion protection may conduct and commissioning, unless otherwise specified by the manufacturer in the instruction manual. The manufacturer shall stipulate the qualifications required by personnel in the instruction manual. These requirements contained in the instruction manual shall be assessed by the notified body during the course of the EU-type examination.

b) "Controlled Design"

Controlled design applications require the use of a temperature control device⁵² to limit the maximum surface temperature. The temperature limiter shall operate independently from the temperature controller. In case of a defective sensor, the trace heating system shall remain de-energized until the defective device is replaced.

The temperature limiter shall be of a design that de-energizes the system to avoid exceeding the maximum permissible surface temperature. In case of a defective limiter system the trace heating system shall remain de-energized until the defective device is replaced.

⁵¹ See also Annex 2 to this section "Type A" and "Type B".

⁵² This can also be realised if need be through the recording of other parameters than the temperature (e.g. electric current).

The Temperature Class of the electrical trace heating system depends on the layout (e.g. defined setting point of temperature limiting device) and the correct installation (e.g. defining the "hot-spot" measuring point and correct positioning of the temperature sensor). The system manufacturer specifies precise instructions for the design, installation and necessary qualifications of the installation personnel in the instruction manual.

A system with a temperature limiter can provide a false presumption of safety if not utilised correctly. Simple use of a temperature limiter is inadequate if other factors are not taken into consideration. Regardless of how the temperature limiter sensor is installed, there will always be a deviation between the temperature at the actual hottest point of the system and the limit temperature configured on the temperature limiter. This deviation can be considerable and depends on:

- the position of the sensor relative to the geometry or position of the heating element;
 - the location of the sensor in the system;
 - the accuracy and configuration range of the temperature limiter;
- the heat transfer between the trace heater and sensor, the work piece to be heated and the immediate surroundings.

The Temperature Class stipulated in the EU-type examination certificate is based on verified design calculations of the manufacturer, which take into account the deviation between limiter set point and the actual maximum surface temperature of the trace heater into consideration. In this case, the maximum surface temperature depends on the correct installation, correct location and position of the sensor and the incorporation of the applicable temperature offset in the set point of the safety device.

The notified body is required to assess these requirements and to take them into consideration in the EU-type examination certificate assessment procedure for the system.

The system is placed on the market by the manufacturer via the installation (i.e. installation with the specified components, affixing of the rating plate and CE marking, the EU declaration of conformity and delivery of the instruction manual). This can be realised by a subcontractor pursuant to appropriate contractual regulations and under the responsibility of the manufacturer.

The subcontractor shall meet all the skills/qualification requirements described in the documentation. This subcontractor may be approved by the manufacturer in possession of the EU-type examination certificate.

Note: The aforesaid does not replace inspections prior to putting into service required by Member State legislation in the field of [Directive 1999/92/EC](#).

Annex 1

Example of a trace heating system:

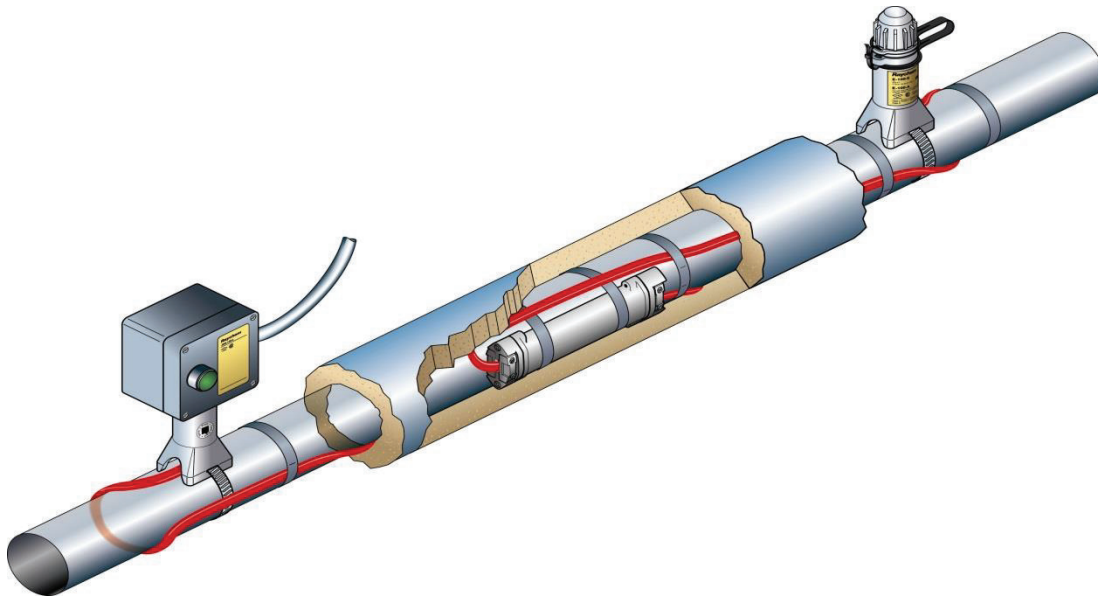

For design, installation and maintenance, the application guide EN 60079-30-2 may be used, this guide is written in conjunction with the product standard EN 60079-30-1, according to which trace heating systems for use in potentially explosive atmospheres are usually assessed and certified.

Annex 2

See on the next page:

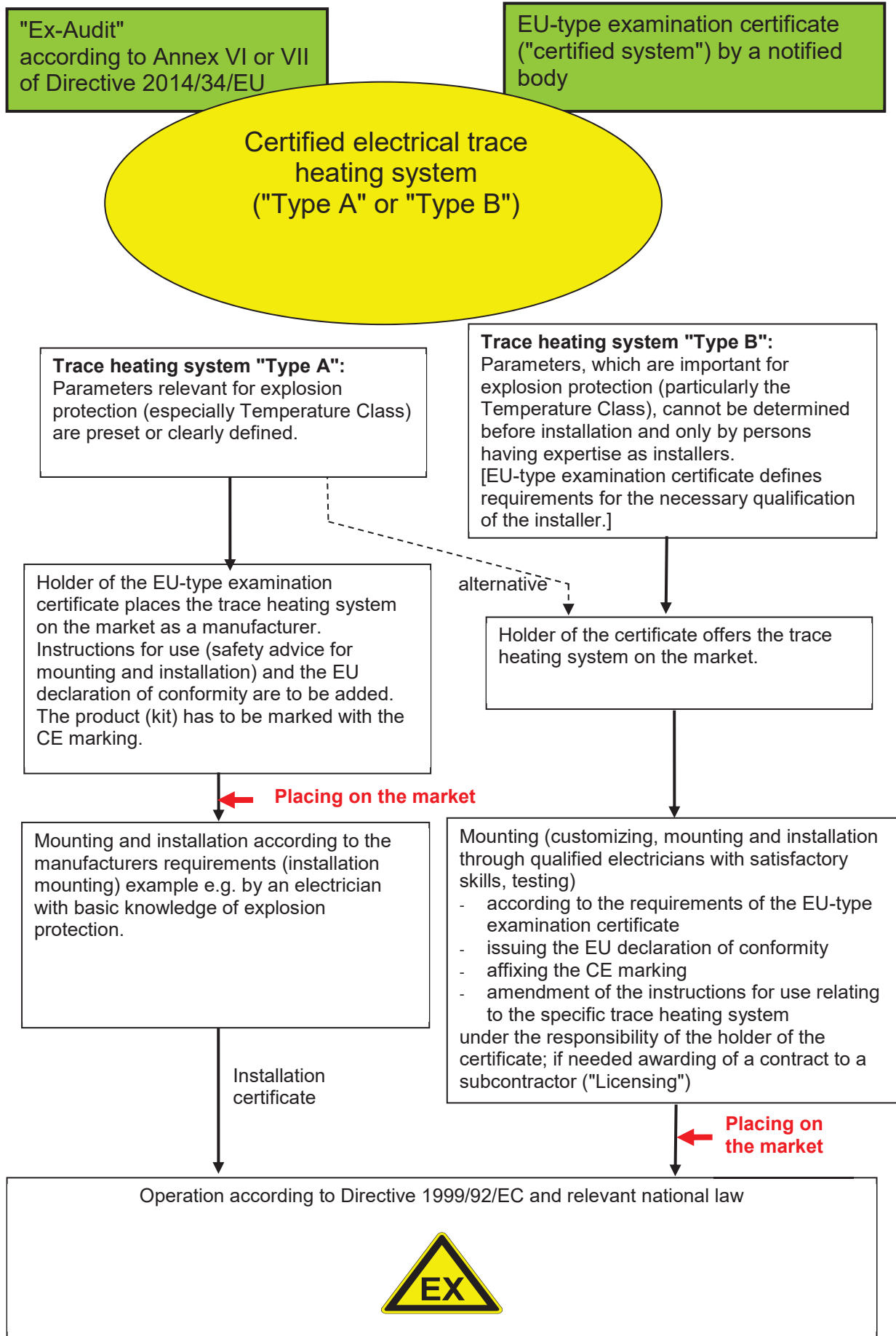

§ 254 Motor protection for category 3 motors

A question arises on the issue of motor protection in relation to ATEX – or to be more precise: is motor protection for category 3 motors covered by the ATEX Directive 2014/34/EU?

In Article 1(1)(b) it is stated that "safety devices, controlling devices and regulating devices intended for use outside potentially explosive atmospheres but required for or contributing to the safe functioning of equipment and protective systems with respect to the risk of explosion" are covered by the scope of Directive 2014/34/EU. Here we normally regard intrinsic safe barriers, motor protections, thermistor relays, Variable Speed Drives (VSD) as "safety devices, controlling devices and regulating devices".

In Annex I, 2. Equipment group II (c) it is stated that "Equipment category 3 comprises equipment designed to be capable of functioning in conformity with the operating parameters established by the manufacturer and ensuring a normal level of protection. Equipment in this category is intended for use in areas in which explosive atmospheres caused by gases, vapours, mists, or air/dust mixtures are unlikely to occur or, if they do occur, are likely to do so only infrequently and for a short period only. Equipment in this category ensures the requisite level of protection during normal operation. Equipment in category 3 ensures the requested level of protection under normal operation".

Is an overload of a motor considered to be "normal" operation?

The answer is: no, with respect to the duty types S1 and S2; yes, with respect to duty types S3 to S10.

The technical specification and requirement of the rotating machine of category 3 is given in the harmonised standard EN 60079-15, item 8 "Supplementary requirements for non-sparking electrical rotating machines", 8.1 "General":

NOTE 1 The requirements of this standard assume that the occurrence of an explosive gas atmosphere and a motor start sequence do not occur simultaneously, and may not be suitable in those cases where these two conditions do occur simultaneously. "Normal" operating conditions for electrical machines are assumed to be rated full-load steady conditions. Starting (acceleration) of electrical machines is excluded as part of "normal" operation under duty S1 or S2. Due to the potential for more frequent starts of motors with duty S3 to S10, the requirements for rotor sparking address the risk of rotor sparking during starting as a "normal" condition. The definitions of duty S1 through S10 are in IEC 60034-1.

The duty type S1 and S2 is more or less defined as starting of the electrical machine not more than once a day.

According to the industrial standards IEC/EN 60034-series the manufacturer has to indicate the duty type on the name plate of the motor.

This requirement and specification is established over the last decades and the temperature tests of the electrical machines category 3 didn't include the over temperature during starting or stalled conditions.

Within the TC 31 WG 27 "Electrical machines" it was agreed that only for electrical machines with the type of protection increased safety 'e' the additional temperature rise during starting and stalled conditions of the stator and rotor shall be measured and considered to determine the temperature class.

Other overload possibilities like reduced cooling through dirt or external sources of heat shall be covered by the user of the equipment (1999/92/EC and not harmonized standards like EN 60079-14 and -17).

Additional remark: the standard EN 60079-14 *Electrical installations design, selection and erection* requires in item 11 "Rotating electrical machines":

11.1 General

Rotating electrical machinery shall additionally be protected against overload unless it can withstand continuously the starting current at rated voltage and frequency or, in the case of generators, the short-circuit current, without inadmissible heating. The overload protective device shall be:

- a) a current-dependent, time lag protective device monitoring all three phases, set at not more than the rated current of the machine, which will operate in 2 h or less at 1,20 times the set current and will not operate within 2 h at 1,05 times the set current, or
- b) a device for direct temperature control by embedded temperature sensors, or
- c) another equivalent device.

Applications of electrical machines in hazardous areas are protected against overload. The aforesaid protection devices for category 3 (zone 2) applications fulfil the common industrial requirements and are not to be considered safety device according to the ATEX directive.

§ 255 Wi-Fi access points

A question arises on requirements for compliance with the ATEX Directive 2014/34/EU on electronic devices like Wi-Fi access points, to be installed into a facility where everything that goes into the factory need to be ATEX compliant.

It is confirmed that also telecommunications equipment have to comply with the essential health and safety requirements of the ATEX Directive when intended to be used in potentially explosive atmospheres, making reference in particular to their "electrical" characteristics, to prevent any potential ignition points by sparks or similar. In the [ATEX Borderline List](#) there are also "Phones and similar equipment e.g. walkie-talkies, head phones etc.", in the scope of the Directive as "electrical equipment with potential ignition sources like heat and sparks of electrical origin".

Consequently, also Wi-Fi access points are covered by the ATEX Directive when used in hazardous zones, due to the electrical and electromagnetic characteristics of such devices as a potential source of ignition, with the necessary provisions against heat and sparks to ensure safety conditions against the risk of explosion.

There are no specific harmonised standard on that – apart of the general requirements in EN 60079 series – but in the same series there are also some non-harmonised standards produced by CENELEC that could be useful, as part 14 on

"Electrical installations in hazardous areas", dealing with different aspects regarding frequency, distance, etc.

Some concrete examples of ATEX-version of telecommunication equipment for use in Ex-Zones can be found in the internet, in particular on "wireless applications in hazardous areas".

§ 256 Refrigerators and storage cabinets for volatile substances

See also the [Borderline list – ATEX products](#).

Refrigerators and cabinets can be used for the storage of volatile substances and may therefore contain a potentially explosive atmosphere. A refrigerator is an item of electrical equipment and may also contain a light etc. Some cabinets contain potential ignition sources such as a fan with an electric motor.

Usually, the product itself is not intended to be operated in a potentially explosive atmosphere (see *Note a*) and would therefore not be within the scope of the ATEX Directive 2014/34/EU; it would fall under the Low Voltage [Directive 2014/35/EU](#) (LVD – see [section § 232](#)). The LVD requires the manufacturer to address hazards that might arise in foreseeable reasonable use (or foreseeable misuse – see *Note b*) from potential ignition sources within the product. ATEX certified parts might be used within the potentially explosive atmosphere or ignition sources may be excluded altogether.





Note a): the possibility of an explosive atmosphere occurring around the refrigerator or cabinet should be assessed by the manufacturer during his risk assessment (in discussion with the user, if possible) taking into account the flashpoint of the liquids, the likely frequency and duration of release, release rate, concentration, velocity, ventilation and other factors affecting the likelihood of an explosive atmosphere being present during the intended use. If a potentially explosive atmosphere is likely to form around the refrigerator or cabinet as a result of vapours from inside exiting and collecting around the unit when the door is opened, it would be considered to be operating in a potentially explosive atmosphere and covered by Directive 2014/34/EU, not LVD. If the manufacturer establishes that an explosive atmosphere is not expected to be present in quantities such as to require special precautions for the construction or use of the refrigerator or cabinet under the conditions of the intended use, the area would be considered as non-hazardous and the product would be covered by LVD, not by Directive 2014/34/EU. In all cases, the instructions for use should inform the user about the preconditions for the safe use of his product. The end-user has to consider the instructions for use and their own responsibilities under the ATEX "workplace" [Directive 1999/92/EC](#).







Note b): it is reasonably foreseeable that the refrigerator or cabinet could be used for the storage of open containers of volatile substances. This is misuse and could lead to dangerous situations. The instructions for use should include warnings against this.







BORDERLINE LIST – ATEX PRODUCTS





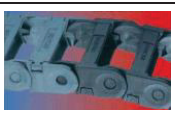

Last update: November 2022

Note: the list is not complete, it only clarifies some common inquires and provide examples of products within or outside the scope of the ATEX Directive 2014/34/EU. The list does not replace the vital risk assessment of each product and in addition, ignition sources and explosion hazards related to the use of all the products shall also always be considered.

Products	Scope of 2014/34/EU (El. = Electrical)	Examples of products	Comments
Equipment			
Automatic lubrication systems	Yes (El.)		Yes, if it is a battery-supplied system and has one or more electrical battery cells above the values specified in "Simple apparatus" clause of EN 60079-11 and if the other criteria for simple apparatus are not met.
Clockworks	-		See § 38 in the ATEX Guidelines ("Simple" products).
Computers	Yes (El.)		
Simple earthing clamps with and without cord	No		"Simple earth clamps" are clamps with a single earth connection. The clamp shall provide evidence that it is actually making contact. No own source of ignition, and for additional considerations, see note 2.
Complex earthing clamps with and without cord	Yes (El.)		The clamp shall provide evidence that it is actually making contact. Potential ignition sources cannot be excluded according to the ignition hazard assessment.
Electrical motors	Yes (El.)		Electrical equipment with potential ignition sources like heat and sparks of electrical origin (e.g. windings, connections) and mechanical origin (e.g. bearings).
Electrical pump with integrated electrical motor (e.g. canned or split tube motor pump, petrol pump/dispensers for petrol filling)	Yes (El.)		Electrical equipment with potential ignition sources like heat and sparks of electrical origin (e.g. motor circuit) and mechanical origin (e.g. pump impeller). Static discharge may occur while pumping/filling in progress.
Electrical fan with integrated electrical motor (e.g. electrical axial fan)	Yes (El.)		Electrical equipment with potential ignition sources like heat and sparks of electrical origin (e.g. motor circuit) and mechanical origin (e.g. fan blades).
Non-electrical fan with integrated air motor (e.g. non-electrical axial fan)	Yes (Non-el.)		Non-electrical equipment with potential ignition sources like frictional heat and sparks of mechanical origin (e.g. bearings, fan blades).
Hand operated valves	No		See section § 38 in the ATEX Guidelines ("Simple" products).
Heating cables	Yes (El.)		Heating cables transform electricity into heat while cables "only" transports electricity. Heating cables may also be components, e.g. heating cables for controlled design applications as part of trace heating systems.
Mechanical brakes	Yes (Non-el.)		Non-electrical equipment with potential ignition sources like frictional heat of mechanical origin.
Mechanical gears	Yes (Non-el.)		Non-electrical equipment with potential ignition sources like frictional heat and sparks of mechanical origin.
Phones and similar equipment e.g. walkie-talkies, head phones etc.	Yes (El.)		Electrical equipment with potential ignition sources like heat and sparks of electrical origin.

Products	Scope of 2014/34/EU (El. = Electrical)	Examples of products	Comments
Refrigerators and storage cabinets for volatile substances	No (but see Note 1) (El.)		See section § 256 in the ATEX Guidelines.
Plugs and socket outlets	Yes (El.)		Electrical equipment with potential ignition sources like sparks of electrical origin (e.g. when connected or disconnected). Note that all countries have special requirements on plugs and socket outlets for domestic use.
Rotary valve	Yes (Non-el.)		Only intended to be used as dosing equipment and not to stop the propagation of an explosion as explosion isolation system. Has to be explosion protected with respects to its ignition sources.
Switches for fixed electrical installations	Yes (El.)		Electrical equipment with potential ignition sources like sparks of electrical origin (e.g. when switched on or off).
Torch	Yes (El.)		Electrical equipment with potential ignition sources like heat and sparks of electrical origin (e.g. sparks from a switch or heat in a bulb or battery).
Extension cord with plug	Yes (El.)		Electrical equipment with potential ignition sources like heat and sparks of electrical origin. Only for temporary use.
Cable reel	Yes (El.)		Electrical equipment with potential ignition sources like heat and sparks of electrical origin. Only for temporary use.
Protective Systems			
Fire extinguisher	No		Intended to be used after an explosion.
Flame arrestors	Yes		Intended to be used to stop the propagation of an explosion. Flame arrestors are used for example on vapour recovery lines on petrol stations to prevent the propagation of an explosion to the underground storage tank or the vehicle.

Products	Scope of 2014/34/EU (El. = Electrical)	Examples of products	Comments
PT 100 sensor	No / Yes		No, when used in an intrinsic safe system together with e.g. a barrier. In all other situations is it to be decided on a case-by-case assessment.
Rotary valve	Yes		Intended to be used not only as dosing equipment but also as explosion isolation system to stop the propagation of an explosion. Has to be explosion protected with respects to its ignition sources and shall fulfil the requirements for protective systems with respect to propagation of an explosion.
Vent panels (for explosion pressure relief)	Yes		Intended to be used to limit the effects of an explosion.
Explosion suppression systems including initiators devices i.e. suppression systems (triggering)	Yes (El.)		Within 2014/34/EU, Article 1.1., with respect to functional and reliability requirements according to the ESHRs 1.5. and 1.6. Initiators can be certified separately as electrical equipment.
Ex Components			
Empty enclosures	Yes (El.)		Intended to be used for electrical equipment with potential ignition sources.
Sight glasses	No		No own source of ignition. However, sight glasses may form part of the enclosure of Ex equipment and be required to fulfil relevant requirements such as for a window in Ex 'd' equipment or impact resistance in Ex 'o' and Ex 'k' equipment.
Spark arrestor	Yes		Intended to prevent an explosion, not to limit it. It is an ATEX component if intended to be built into ATEX equipment or protective systems.
Magnetic catches for doors etc.	No		No autonomous function; not essential to safe functioning of ATEX equipment or protective system.
Safety, Controlling or Regulating devices			
Devices controlling the regular safety limits of an industrial process handling flammables, like pressure, level and temperature transmitters	No		Shall be protected as potential ignition sources themselves if placed inside hazards areas, but safety devices with respect to risks other than ignition hazards + monitoring devices providing only an alarm signal, but without direct control function, are outside scope of the directive (with respect to reliability and functional requirements according to the ESHR, clauses 1.5. and 1.6.).
Overload or temperature protective devices, inhibiting ignition sources from becoming active (e.g. current-dependent device for Exe motor)	Yes (El.)		Within Directive 2014/34/EU, Article 1.1., with respect to functional and reliability requirements according to the ESHR, clauses 1.5. and 1.6.
Other products			
Cables	No		No autonomous function; not essential to safe functioning of ATEX equipment or protective system.
Cable ladder and chain/handler systems	No		No autonomous function; not essential to safe functioning of ATEX equipment or protective system; no own source of ignition. For additional considerations, see Note 2.
Power transmission belt or conveyor belts	No		No autonomous function; not essential to safe functioning of ATEX equipment or protective system. No own source of ignition, and for additional considerations, see Note 2.

Products	Scope of 2014/34/EU (El. = Electrical)	Examples of products	Comments
			Hazards during operation, e.g. potential electrostatic risks overheating and operating temperature limits, flame retardant properties (reference standard EN 80079-37) are to be considered by the manufacturer of the equipment, where the belts are incorporated.
Conduits/pipes /hoses: e.g. Fume extraction arms and conduits for electrical installations (except for conduits intended to be used between the flameproof enclosures and the conduit sealing devices), Metal-hose assembly or non-conductive hose assemblies with or without metal fittings	No		No autonomous function; not essential to safe functioning of ATEX equipment or protective system
Cable lugs/shoes with and without cord	No		No autonomous function; not essential to safe functioning of ATEX equipment or protective system.
Electro Static Discharge (ESD) - protections: e.g. wristles, shoes, standing mats, antistatic bags	No		No autonomous function; not essential to safe functioning of ATEX equipment or protective system.
Doors	No		No. None automatic doors are considered as a part of the fixed walls and are not operated in the presence of explosive atmospheres. For additional considerations, see Note 2.
Filter-Element, non-conductive for use in flammable liquids and gases	No		No autonomous function; not essential to safe functioning of ATEX equipment. No own source of ignition. For additional considerations, see Note 2. Hazards during operation, e.g. potential electrostatic risks are to be considered by the manufacturer of the equipment, where the filters are incorporated.
Filter housing (non-conductive and conductive) for use with flammable liquids and gases and/or in hazardous area	No		No autonomous function; not essential to safe functioning of ATEX equipment. No own source of ignition. Hazards during operation, e.g. possible electrostatic risks, must be considered by the manufacturer of the equipment, which is under scope of 2014/34/EU and where the filter housing is installed. For additional considerations, see Note 2.
Ladders, irrespective of the material	No		No own source of ignition.
Paint	No		No own source of ignition.
Tank	No		No own source of ignition.
Tools: e.g. hammers, tongs	No		No own source of ignition.
Products, which are not intended to be used in an explosive atmosphere but explosive atmosphere can occur inside of the product.			
Spiral jet mill	No		If there is a dynamic shifting device or fluidized bed opposed jet mill and moving parts inside. Equipment inside of the mill (e. c. mechanical parts as part of the complete apparatus) with

Products	Scope of 2014/34/EU (El. = Electrical)	Examples of products	Comments
			<p>the potential to create an ignition risk, must comply with the Directive 2014/34/EU (see section § 34 on place of intended use).</p> <p>Electrostatic hazards caused by material during operation has to be covered by Directive 2006/42/EG (machine directive) or the end-user according to directive 1999/92/EG.</p>

Note 1: Additional information can be obtained not only in the ATEX Guidelines to Directive 2014/34/EU, but also in the "[Non-binding guide to good practice for implementing the European Parliament and Council Directive 1999/92/EC](#)".

Note 2: Equipment, protective systems, Ex components, safety, controlling, regulating devices and/or other products indicated as not falling within the scope of the ATEX Directive 2014/34/EU, ignition sources and explosion hazards related to the use shall be considered. Friction impacts and abrasion processes involving rust and light metals (e.g. aluminium and magnesium) and their alloys may initiate an aluminothermic (thermite) reaction, which can give rise to particularly incendive sparking.

SPECIFIC MARKING OF EXPLOSION PROTECTION (ϵ x) DRAWN FROM DIRECTIVE 84/47/EEC

The validity of the Commission Directive 84/47/EEC of 16 January 1984 adapting to technical progress Council Directive 79/196/EEC on the approximation of the laws of the Member States concerning electrical equipment for use in potentially explosive atmospheres employing certain types of protection (OJ L 31, 2.2.1984, p. 19) ended on 1 July 2003, when the ATEX Directive 94/9/EC became applicable; but the description of the ϵ x marking ("epsilon-x" or "the hexagon"), although it has not been retained in the new legislation, remains useful as guidance for manufacturers and all the interested parties.

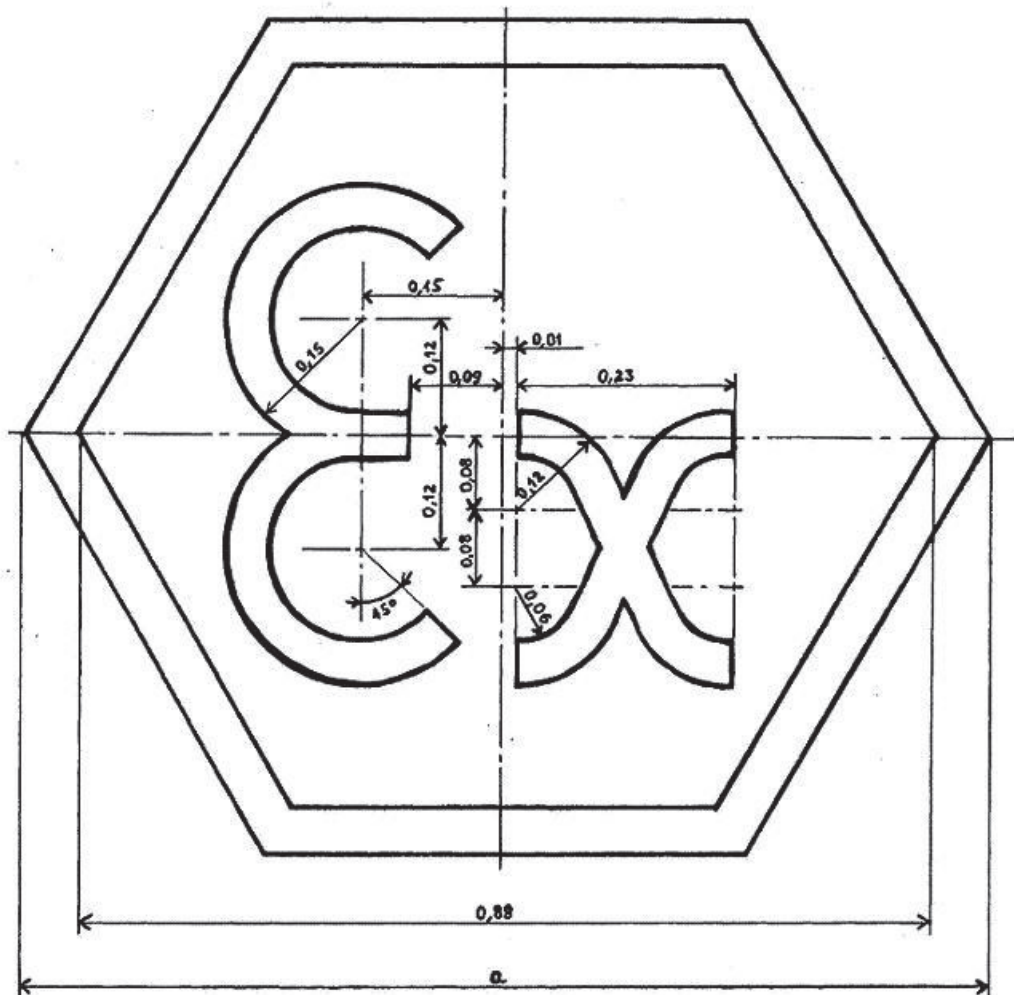

All values related to 'a'

USEFUL ATEX WEBSITES

Sectoral / vertical:

- Directive 2014/34/EU (multi-lingual texts) in EUR-Lex: <http://eur-lex.europa.eu/legal-content/EN/TXT/?qid=1460102657898&uri=CELEX:32014L0034>
- European Commission's website on Equipment for potentially explosive atmospheres (ATEX): <http://ec.europa.eu/growth/sectors/mechanical-engineering/atex/>
 - ATEX 2014/34/EU Guidelines: <http://ec.europa.eu/DocsRoom/documents/16402/attachments/1/translations>
 - Consolidated minutes of the ATEX Working Group meetings: <http://ec.europa.eu/DocsRoom/documents/17761/attachments/1/translations/>
 - Standardisation for ATEX: <http://ec.europa.eu/growth/single-market/european-standards/harmonised-standards/equipment-explosive-atmosphere/>
 - ATEX notified bodies in NANDO: http://ec.europa.eu/growth/tools-databases/nando/index.cfm?fuseaction=directive.notifiedbody&dir_id=153101
 - Contact points: <http://ec.europa.eu/DocsRoom/documents/16122/attachments/1/translations/en/renditions/native>
 - Market Surveillance Authorities: <http://ec.europa.eu/DocsRoom/documents/16123/attachments/1/translations/en/renditions/native>
- CEN/TC 305 Potentially explosive atmospheres - Explosion prevention and protection: https://standards.cen.eu/dyn/www/f?p=204:7:0:::FSP_ORG_ID:6286&cs=1DBA2E1F81140C9AE9D8C65E805416228
- CLC/TC 31 Electrical apparatus for potentially explosive atmospheres: https://www.cenelec.eu/dyn/www/f?p=104:7:1487418331647801:::FSP_ORG_ID,FSP_LANG_ID:1257157,25
- ATEX Interest Groups on CIRCABC:
 - ATEX Committee: <https://circabc.europa.eu/w/browse/7e5ba403-cd84-4c2c-96c7-221ec695c9b9>
 - ATEX Directive: <https://circabc.europa.eu/w/browse/0cb52e92-2074-480c-8235-a4cac539d591>
 - ATEX Administrative Co-operation group: <https://circabc.europa.eu/w/browse/95700477-ba5c-4b52-9552-2375dc1a808d>
 - ATEX Group of Notified Bodies: <https://circabc.europa.eu/w/browse/33b0bed8-1c65-4d9e-b857-1f34d2d91c04>

Inter-sectoral / horizontal:

- New Legislative Framework: <http://ec.europa.eu/growth/single-market/goods/new-legislative-framework/>
 - Conformity assessment: http://ec.europa.eu/growth/single-market/goods/building-blocks/conformity-assessment_en
 - Notified bodies: http://ec.europa.eu/growth/single-market/goods/building-blocks/notified-bodies_en
 - Market surveillance for products: http://ec.europa.eu/growth/single-market/goods/building-blocks/market-surveillance_en
 - Information and Communication System on Market Surveillance (ICSMS): http://ec.europa.eu/growth/single-market/goods/building-blocks/icsms_en
- The 'Blue Guide' on the implementation of EU product rules 2016: <http://ec.europa.eu/DocsRoom/documents/18027>
- CE marking: <http://ec.europa.eu/growth/single-market/ce-marking/>